

ashika®

© 2011

**QUALITY TESTED
GAS SPRING AND
POWER
LIFTGATE STRUTS
TECNICAL
DRAWINGS**

CATALOGUE

FOR CARS AND COMMERCIAL
VEHICLES

CATALOGO

PER AUTOMOBILI E VEICOLI
COMMERCIALI

www.ashika.it

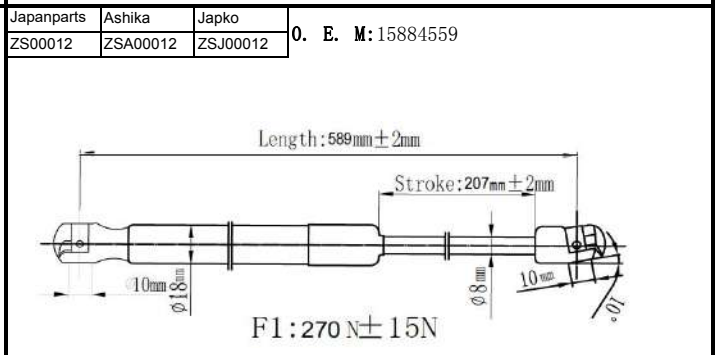
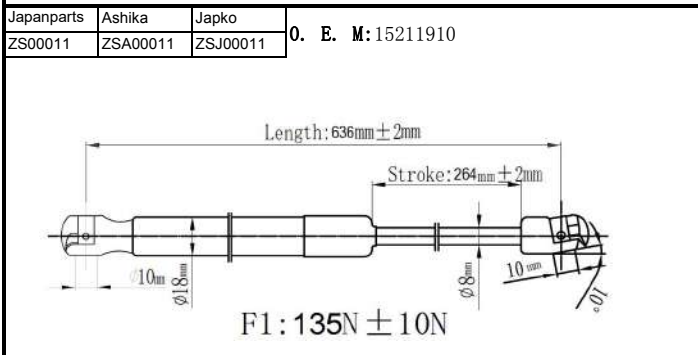
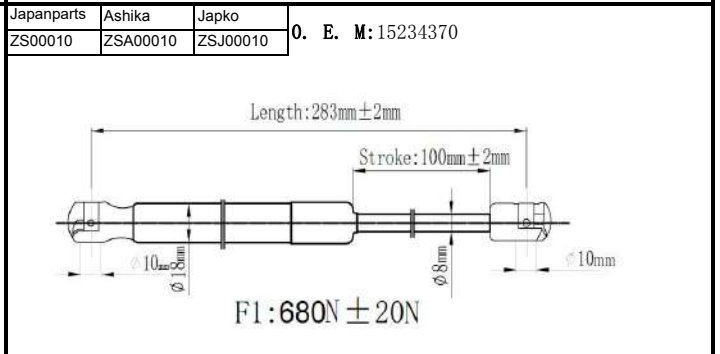
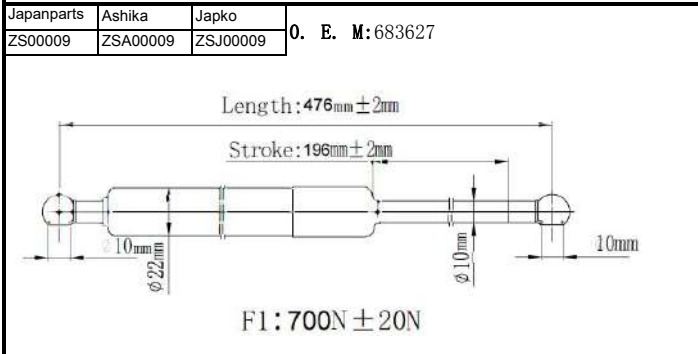
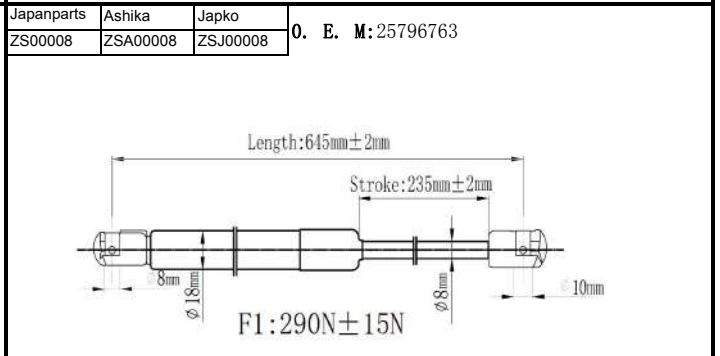
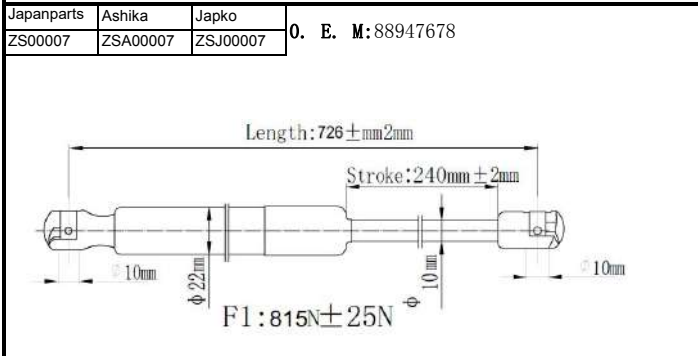
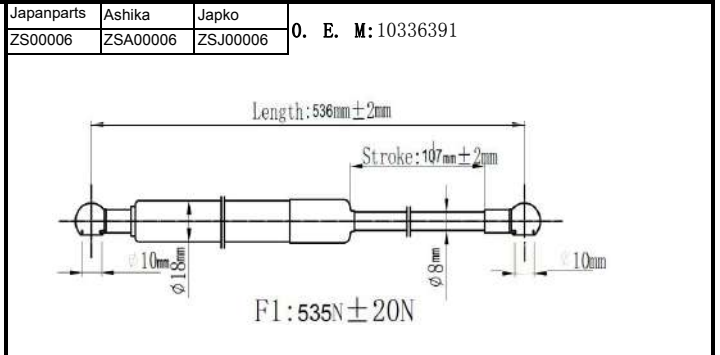
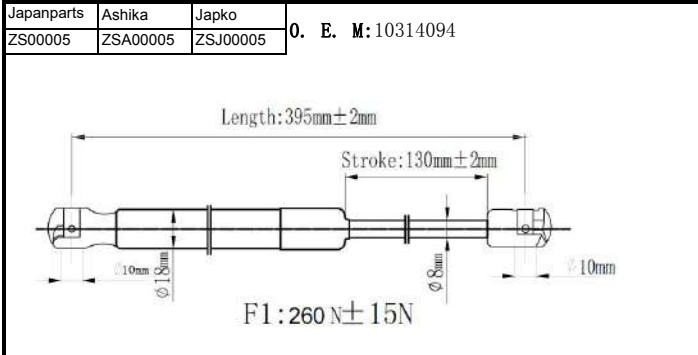
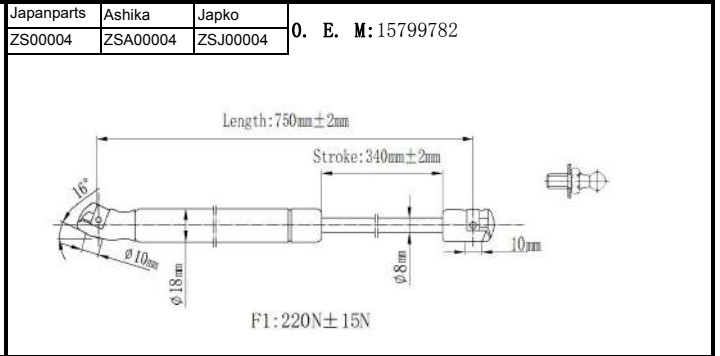
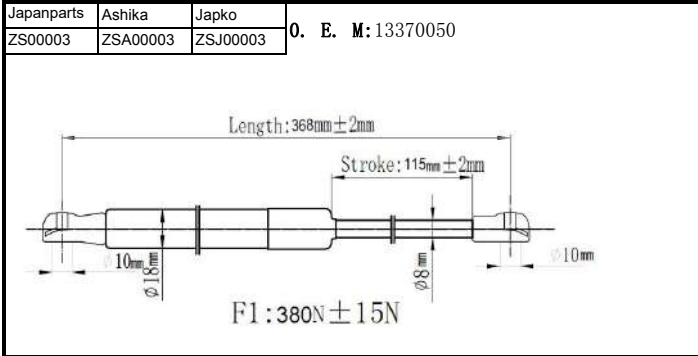
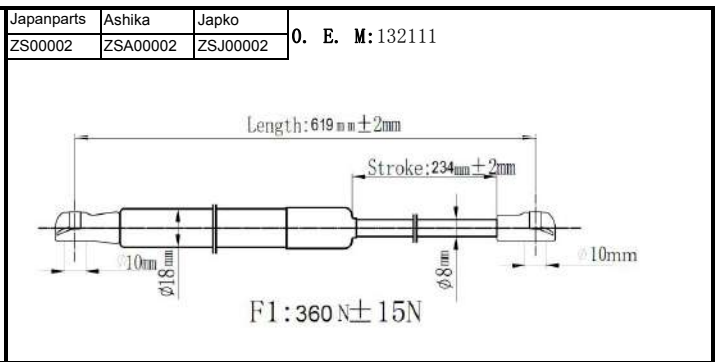
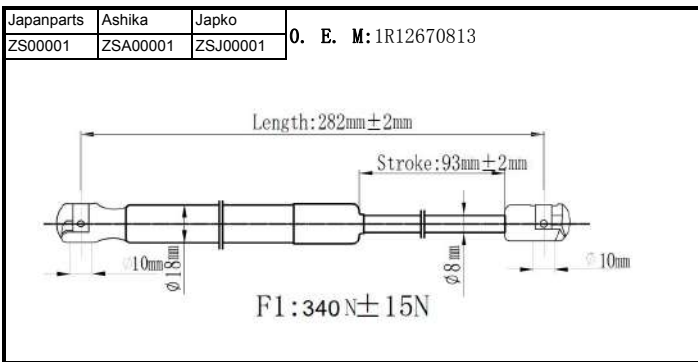

| | | |
|------------|----------|----------|
| Japanparts | Ashika | Japko |
| ZS00013 | ZSA00013 | ZSJ00013 |

O. E. M: 15845091

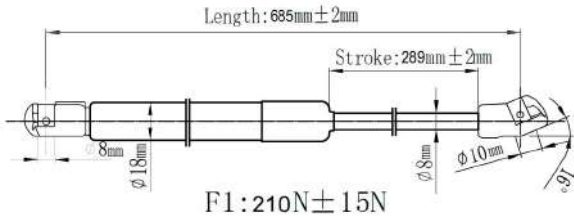

| | | |
|------------|----------|----------|
| Japanparts | Ashika | Japko |
| ZS00014 | ZSA00014 | ZSJ00014 |

O. E. M: 15161943

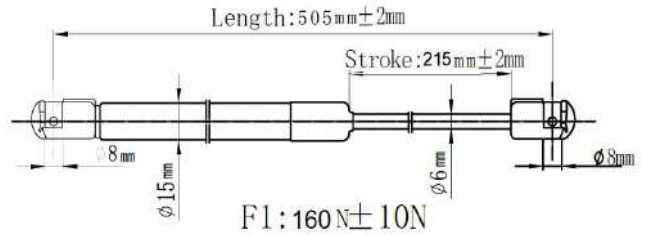

| | | |
|------------|----------|----------|
| Japanparts | Ashika | Japko |
| ZS00015 | ZSA00015 | ZSJ00015 |

O. E. M: 15029087

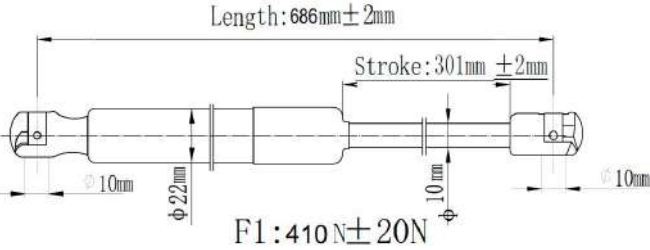

| | | |
|------------|----------|----------|
| Japanparts | Ashika | Japko |
| ZS00016 | ZSA00016 | ZSJ00016 |

O. E. M: 384300122

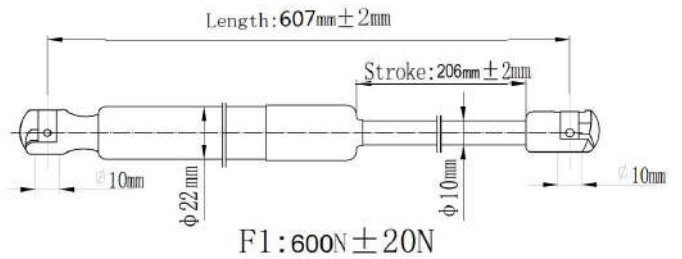

| | | |
|------------|----------|----------|
| Japanparts | Ashika | Japko |
| ZS00017 | ZSA00017 | ZSJ00017 |

O. E. M: 176600

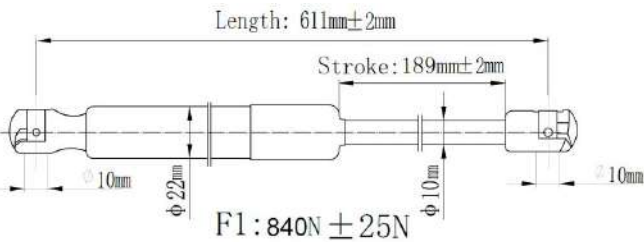

| | | |
|------------|----------|----------|
| Japanparts | Ashika | Japko |
| ZS00018 | ZSA00018 | ZSJ00018 |

O. E. M: 6895019275

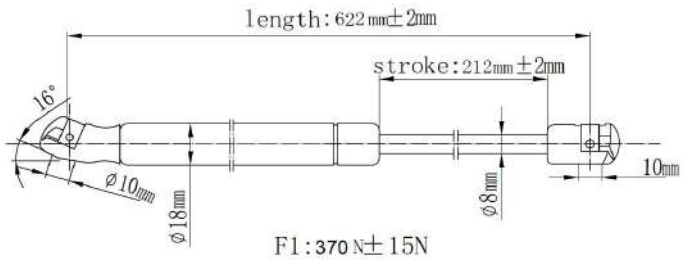

| | | |
|------------|----------|----------|
| Japanparts | Ashika | Japko |
| ZS00019 | ZSA00019 | ZSJ00019 |

O. E. M: 15911948

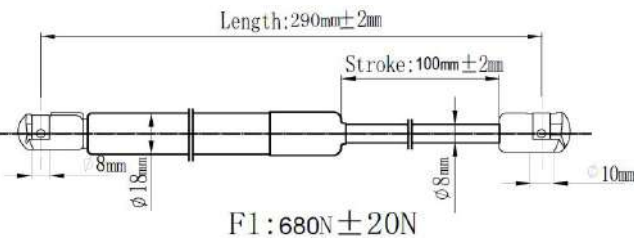

| | | |
|------------|----------|----------|
| Japanparts | Ashika | Japko |
| ZS00020 | ZSA00020 | ZSJ00020 |

O. E. M: 15938028

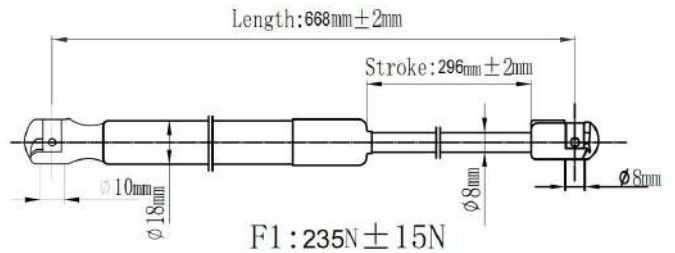

| | | |
|------------|----------|----------|
| Japanparts | Ashika | Japko |
| ZS00021 | ZSA00021 | ZSJ00021 |

O. E. M: 654710944R

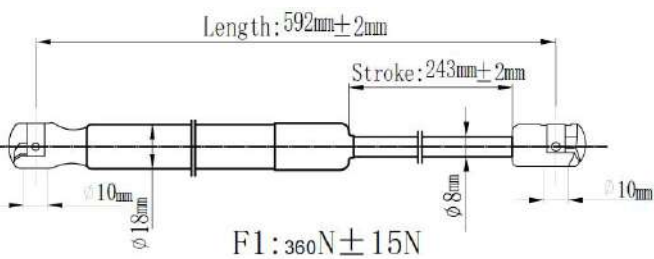

| | | |
|------------|----------|----------|
| Japanparts | Ashika | Japko |
| ZS00022 | ZSA00022 | ZSJ00022 |

O. E. M: 654704175R

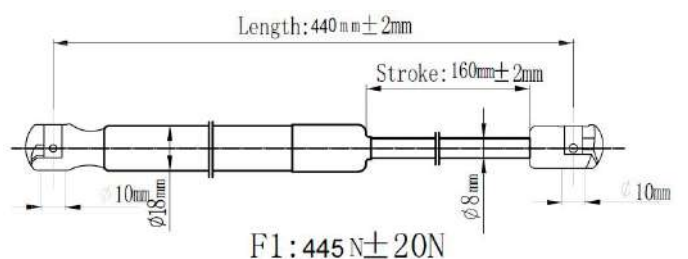

| | | |
|------------|----------|----------|
| Japanparts | Ashika | Japko |
| ZS00023 | ZSA00023 | ZSJ00023 |

O. E. M: 654713274R

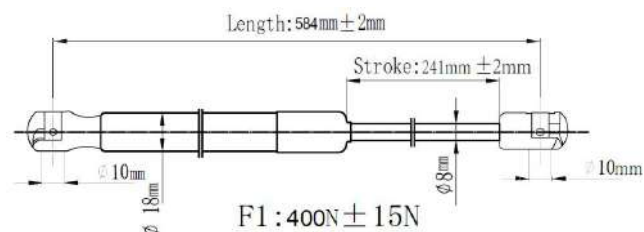

| | | |
|------------|----------|----------|
| Japanparts | Ashika | Japko |
| ZS00024 | ZSA00024 | ZSJ00024 |

O. E. M: 60592800

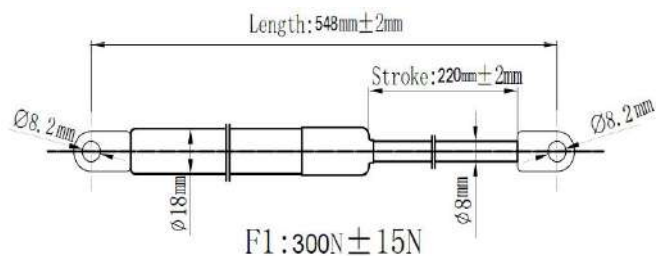

| | | | |
|------------|----------|----------|--------------------|
| Japanparts | Ashika | Japko | O. E. M.: 62175300 |
| ZS00025 | ZSA00025 | ZSJ00025 | |

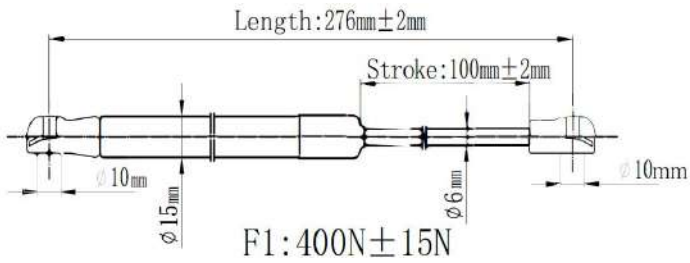

| | | | |
|------------|----------|----------|--------------------|
| Japanparts | Ashika | Japko | O. E. M.: 15230038 |
| ZS00026 | ZSA00026 | ZSJ00026 | |

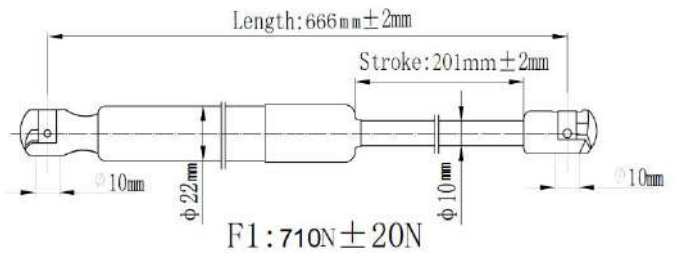

| | | | |
|------------|----------|----------|--------------------|
| Japanparts | Ashika | Japko | O. E. M.: 53471007 |
| ZS00027 | ZSA00027 | ZSJ00027 | |

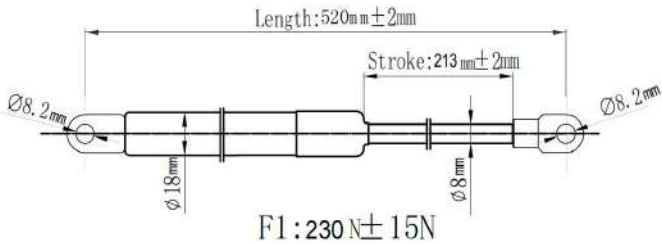

| | | | |
|------------|----------|----------|--------------------|
| Japanparts | Ashika | Japko | O. E. M.: BBC13515 |
| ZS00028 | ZSA00028 | ZSJ00028 | |

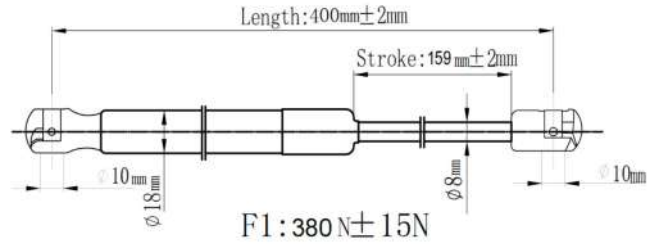

| | | | |
|------------|----------|----------|------------------------|
| Japanparts | Ashika | Japko | O. E. M.: 2W9316C826AB |
| ZS00029 | ZSA00029 | ZSJ00029 | |

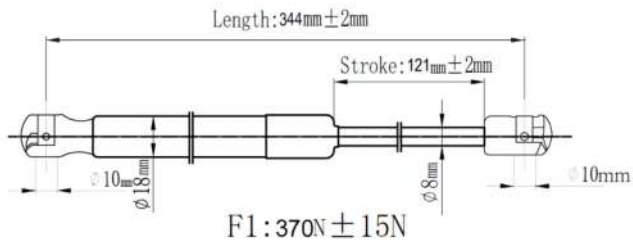

| | | | |
|------------|----------|----------|---------------------|
| Japanparts | Ashika | Japko | O. E. M.: GNA3800AB |
| ZS00030 | ZSA00030 | ZSJ00030 | |

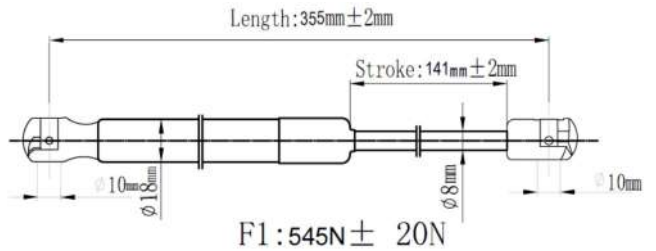

| | | | |
|------------|----------|----------|------------------------|
| Japanparts | Ashika | Japko | O. E. M.: 6W8316C826AB |
| ZS00031 | ZSA00031 | ZSJ00031 | |

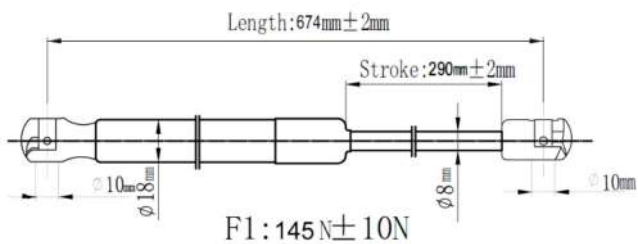

| | | | |
|------------|----------|----------|---------------------|
| Japanparts | Ashika | Japko | O. E. M.: HJA2500AB |
| ZS00032 | ZSA00032 | ZSJ00032 | |

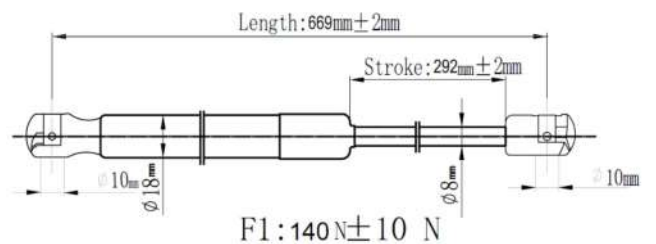

| | | | |
|------------|----------|----------|-------------------------|
| Japanparts | Ashika | Japko | O. E. M.: 1X43F406A10AB |
| ZS00033 | ZSA00033 | ZSJ00033 | |

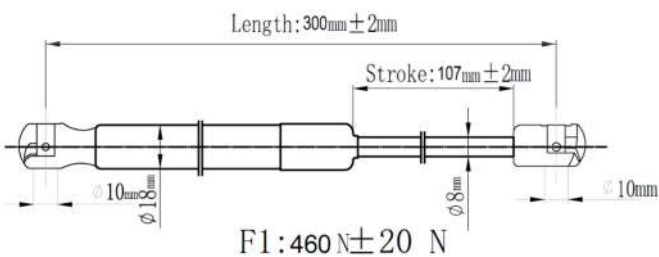

| | | | |
|------------|----------|----------|-------------------------|
| Japanparts | Ashika | Japko | O. E. M.: 2W93F406A10AF |
| ZS00034 | ZSA00034 | ZSJ00034 | |

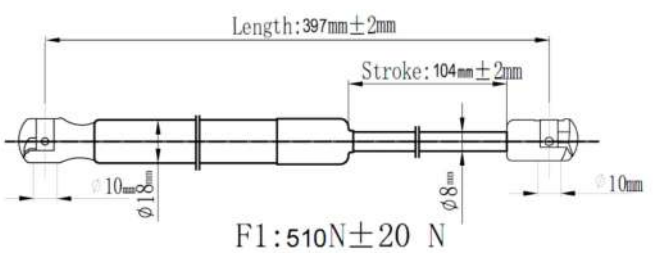

| | | | |
|------------|----------|----------|------------------------|
| Japanparts | Ashika | Japko | O. E. M.: 8X2316C826AC |
| ZS00035 | ZSA00035 | ZSJ00035 | |

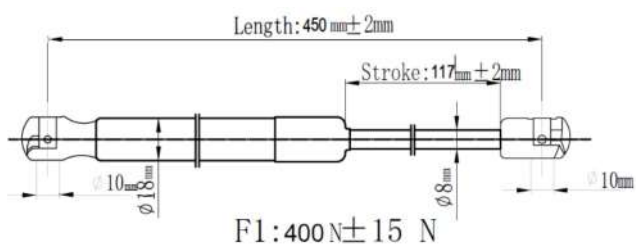

| | | | |
|------------|----------|----------|------------------------|
| Japanparts | Ashika | Japko | O. E. M.: 8X23406A42AC |
| ZS00036 | ZSA00036 | ZSJ00036 | |

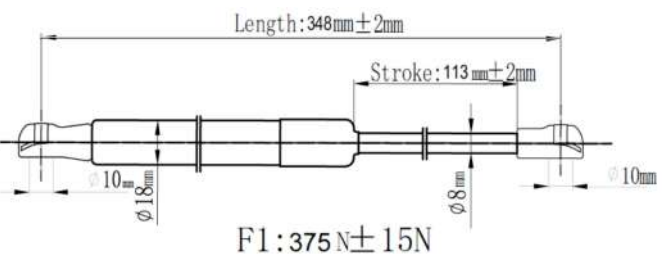

| | | |
|------------|----------|----------|
| Japanparts | Ashika | Japko |
| ZS00037 | ZSA00037 | ZSJ00037 |

O. E. M.: AW9316C826AC

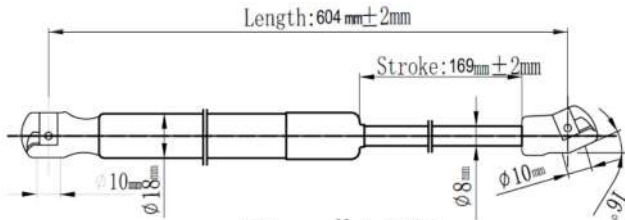

F1: 310N ± 15N

| | | |
|------------|----------|----------|
| Japanparts | Ashika | Japko |
| ZS00038 | ZSA00038 | ZSJ00038 |

O. E. M.: BD48027

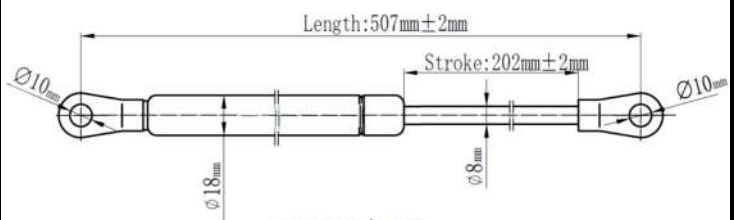

F1: 210N ± 15N

| | | |
|------------|----------|----------|
| Japanparts | Ashika | Japko |
| ZS00039 | ZSA00039 | ZSJ00039 |

O. E. M.: EX5316C826AB

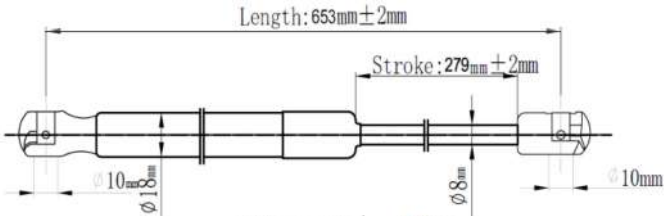

F1: 165N ± 10N

| | | |
|------------|----------|----------|
| Japanparts | Ashika | Japko |
| ZS00040 | ZSA00040 | ZSJ00040 |

O. E. M.: GJA3800BB

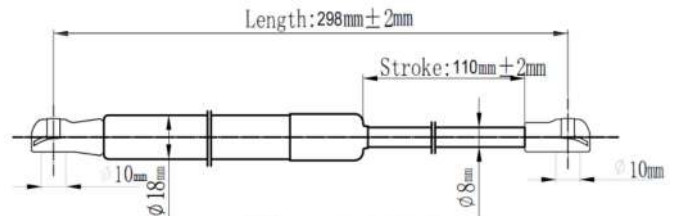

F1: 370N ± 15N

| | | |
|------------|----------|----------|
| Japanparts | Ashika | Japko |
| ZS00041 | ZSA00041 | ZSJ00041 |

O. E. M.: 11188231015

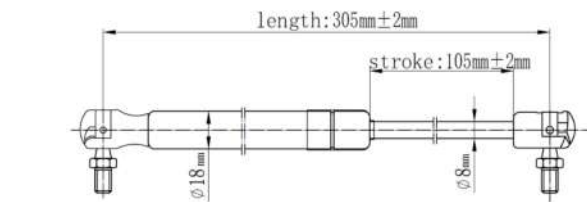

F1: 415N ± 20N

| | | |
|------------|----------|----------|
| Japanparts | Ashika | Japko |
| ZS00042 | ZSA00042 | ZSJ00042 |

O. E. M.: 21216308015

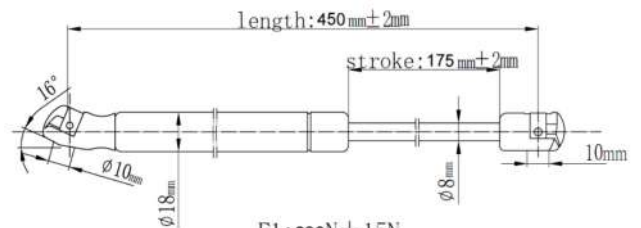

F1: 280N ± 15N

| | | |
|------------|----------|----------|
| Japanparts | Ashika | Japko |
| ZS00043 | ZSA00043 | ZSJ00043 |

O. E. M.: 21118231010

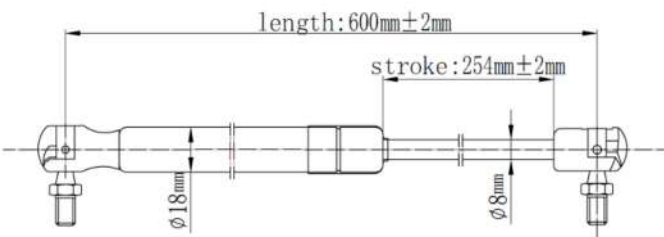

F1: 460N ± 20N

| | | |
|------------|----------|----------|
| Japanparts | Ashika | Japko |
| ZS00044 | ZSA00044 | ZSJ00044 |

O. E. M.: 21128231010

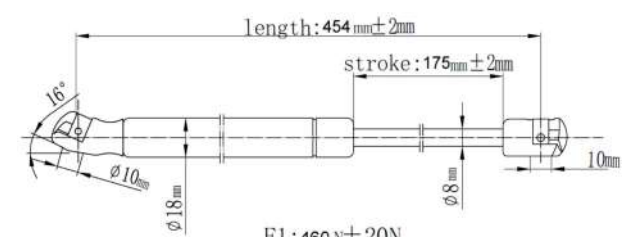

F1: 460N ± 20N

| | | |
|------------|----------|----------|
| Japanparts | Ashika | Japko |
| ZS00045 | ZSA00045 | ZSJ00045 |

O. E. M.: 7700786247

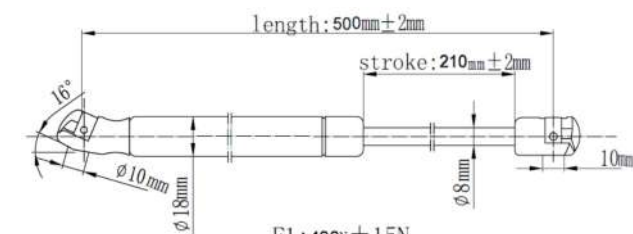

F1: 400N ± 15N

| | | |
|------------|----------|----------|
| Japanparts | Ashika | Japko |
| ZS00046 | ZSA00046 | ZSJ00046 |

O. E. M.: F85Z16C826AB

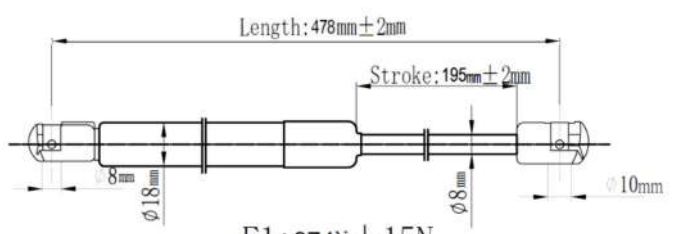

F1: 374N ± 15N

| | | |
|------------|----------|----------|
| Japanparts | Ashika | Japko |
| ZS00047 | ZSA00047 | ZSJ00047 |

O. E. M.: 1W4Z16C826BA

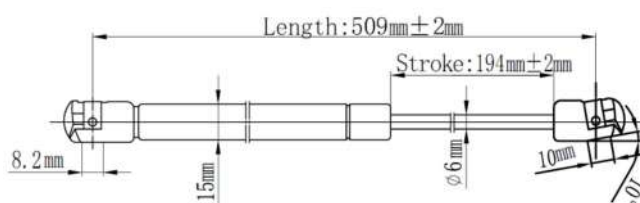

F1: 192N ± 10N

| | | |
|------------|----------|----------|
| Japanparts | Ashika | Japko |
| ZS00048 | ZSA00048 | ZSJ00048 |

O. E. M.: 2L7416C826AC

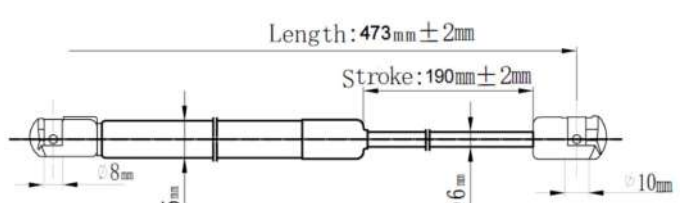

F1: 375N ± 15N

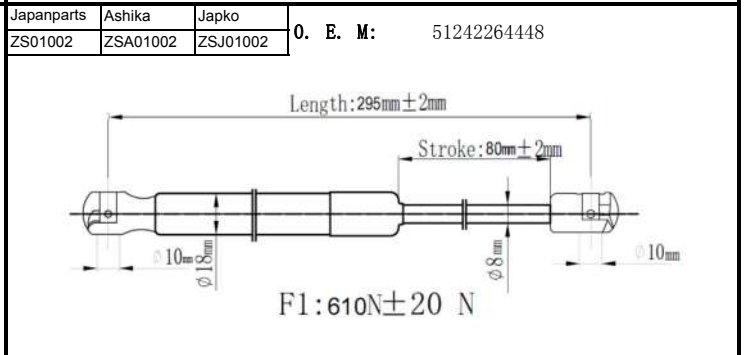
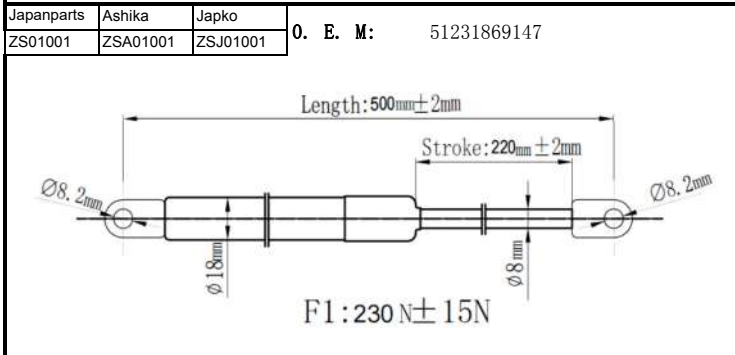
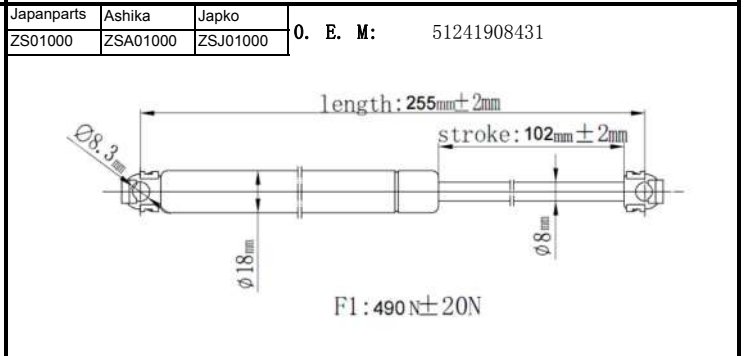
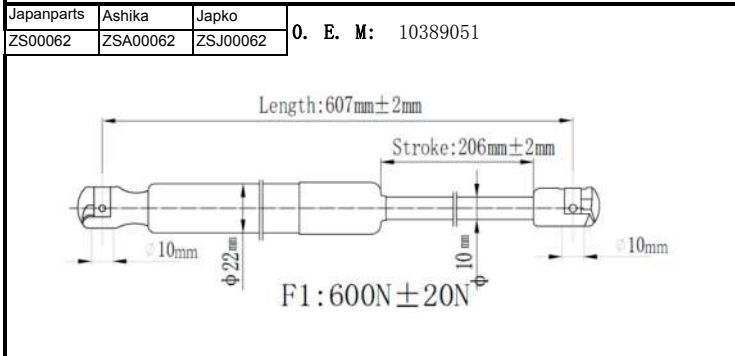
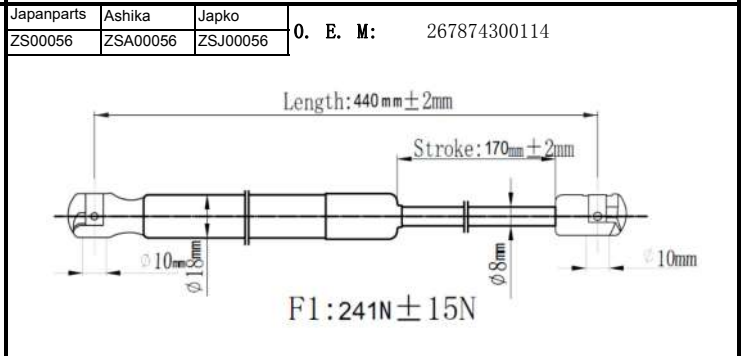
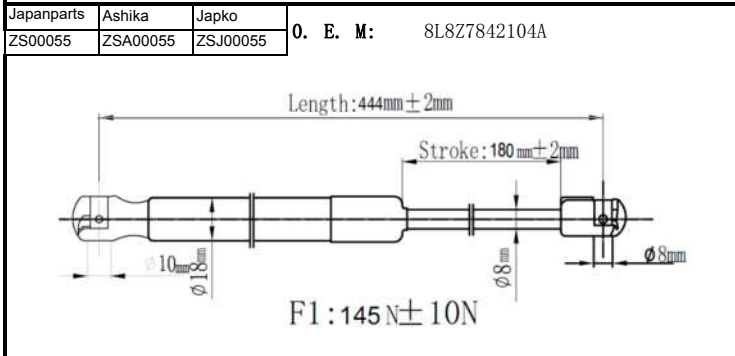
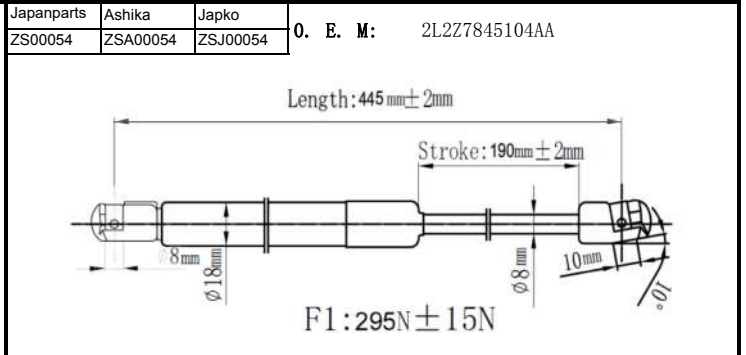
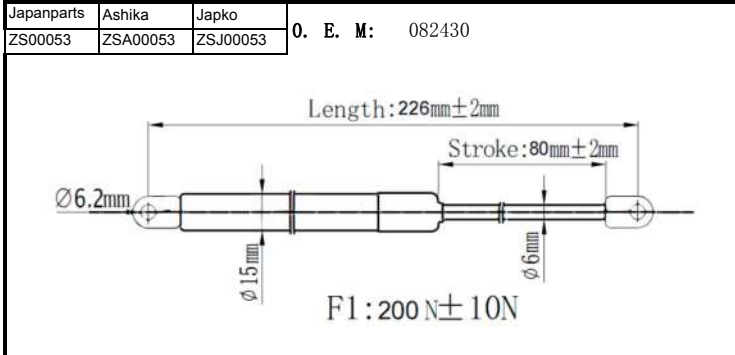
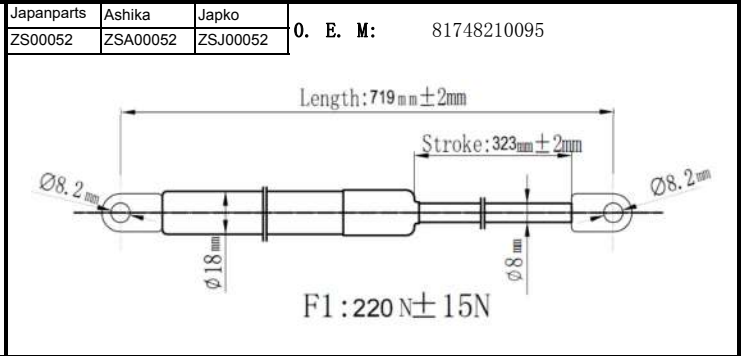
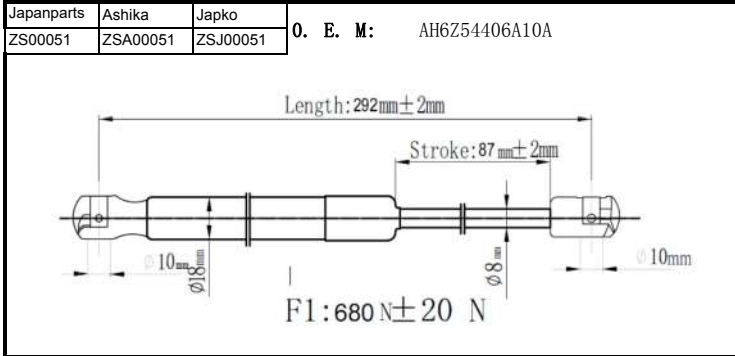
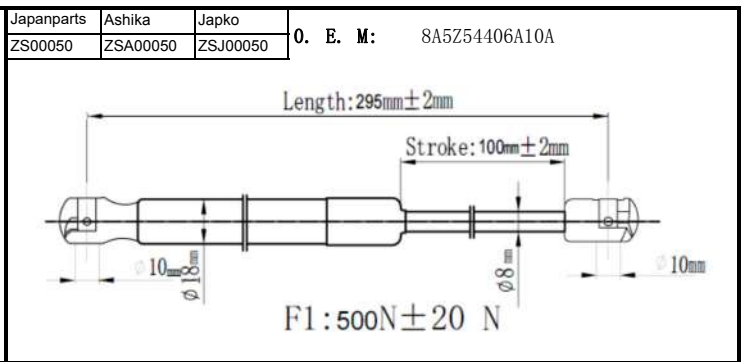
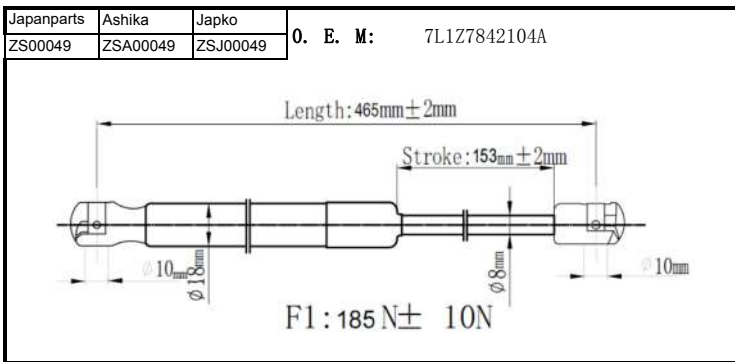

| | | |
|------------|----------|----------|
| Japanparts | Ashika | Japko |
| ZS01003 | ZSA01003 | ZSJ01003 |

O. E. M.: 51248206652

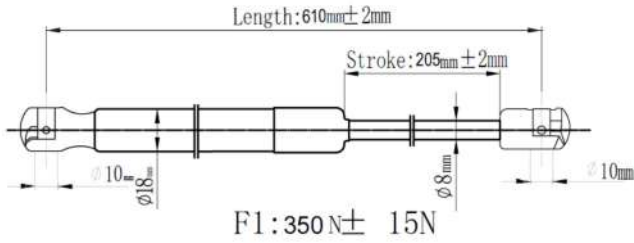

| | | |
|------------|----------|----------|
| Japanparts | Ashika | Japko |
| ZS01004 | ZSA01004 | ZSJ01004 |

O. E. M.: 51248230070

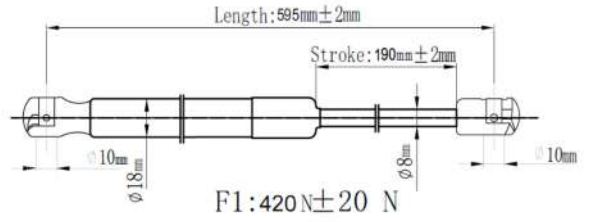

| | | |
|------------|----------|----------|
| Japanparts | Ashika | Japko |
| ZS01005 | ZSA01005 | ZSJ01005 |

O. E. M.: 51244212802

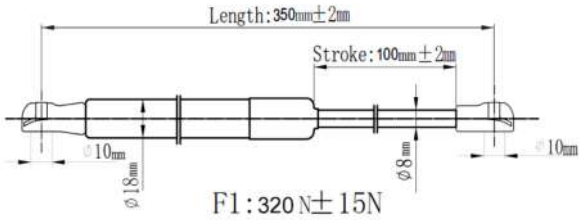

| | | |
|------------|----------|----------|
| Japanparts | Ashika | Japko |
| ZS01006 | ZSA01006 | ZSJ01006 |

O. E. M.: 51248227895

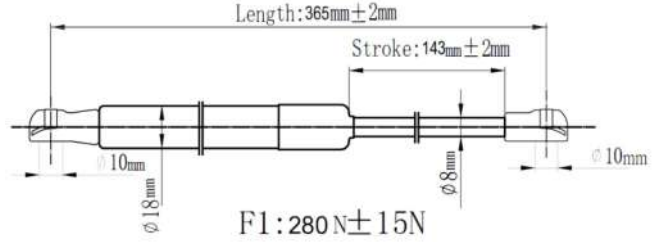

| | | |
|------------|----------|----------|
| Japanparts | Ashika | Japko |
| ZS01007 | ZSA01007 | ZSJ01007 |

O. E. M.: 51248159239

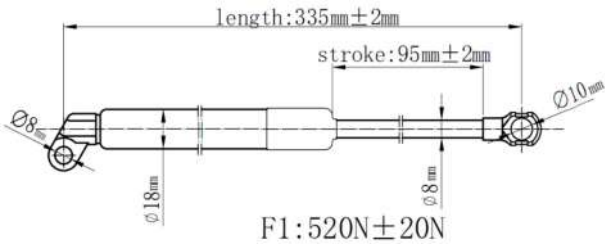

| | | |
|------------|----------|----------|
| Japanparts | Ashika | Japko |
| ZS01008 | ZSA01008 | ZSJ01008 |

O. E. M.: 51248399087

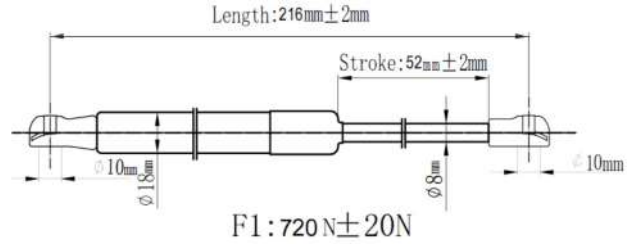

| | | |
|------------|----------|----------|
| Japanparts | Ashika | Japko |
| ZS01009 | ZSA01009 | ZSJ01009 |

O. E. M.: 1947096

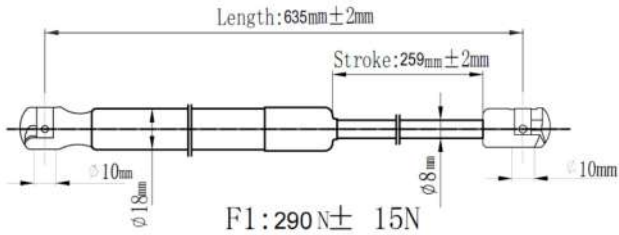

| | | |
|------------|----------|----------|
| Japanparts | Ashika | Japko |
| ZS01010 | ZSA01010 | ZSJ01010 |

O. E. M.: 51248103118

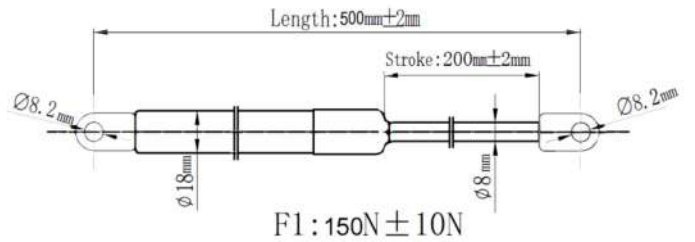

| | | |
|------------|----------|----------|
| Japanparts | Ashika | Japko |
| ZS01011 | ZSA01011 | ZSJ01011 |

O. E. M.: 51233400352

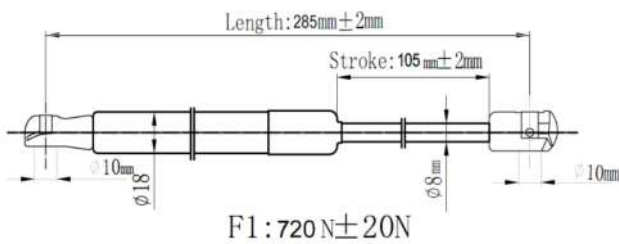

| | | |
|------------|----------|----------|
| Japanparts | Ashika | Japko |
| ZS01012 | ZSA01012 | ZSJ01012 |

O. E. M.: 51231960852

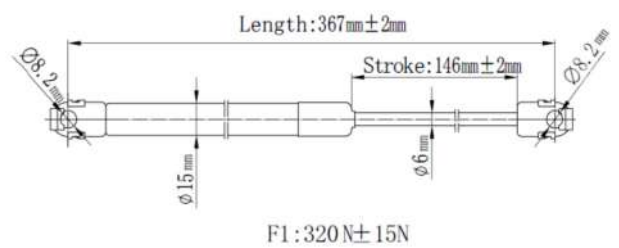

| | | |
|------------|----------|----------|
| Japanparts | Ashika | Japko |
| ZS01013 | ZSA01013 | ZSJ01013 |

O. E. M.: 51238119558

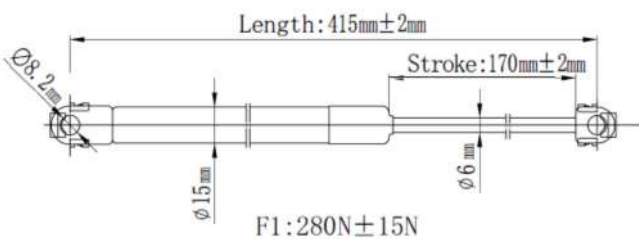

| | | |
|------------|----------|----------|
| Japanparts | Ashika | Japko |
| ZS01014 | ZSA01014 | ZSJ01014 |

O. E. M.: 51241960862

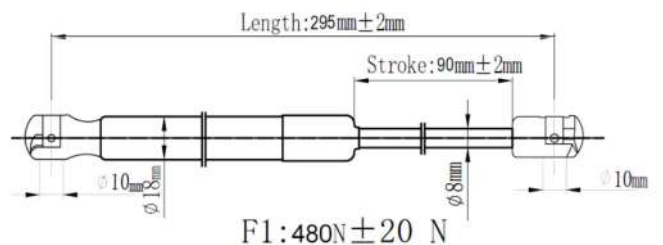

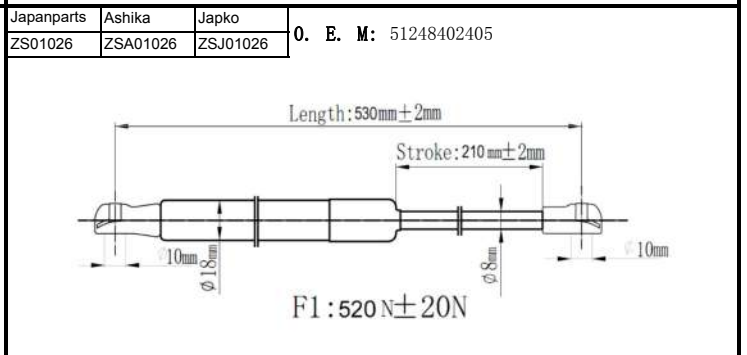
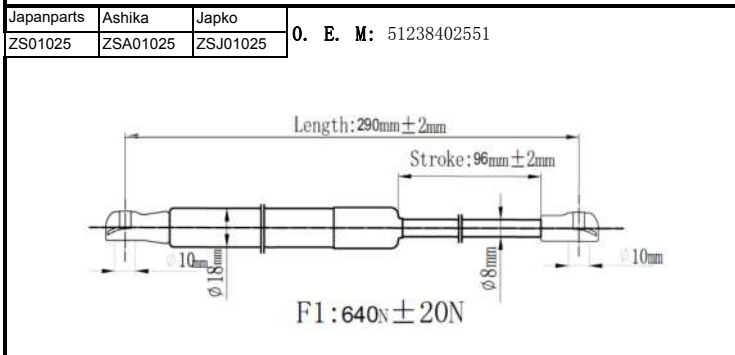
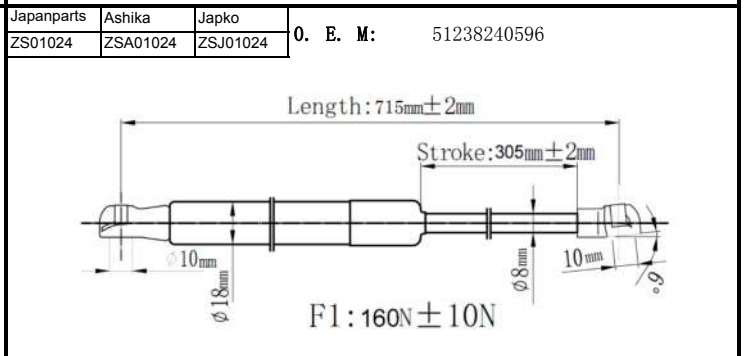
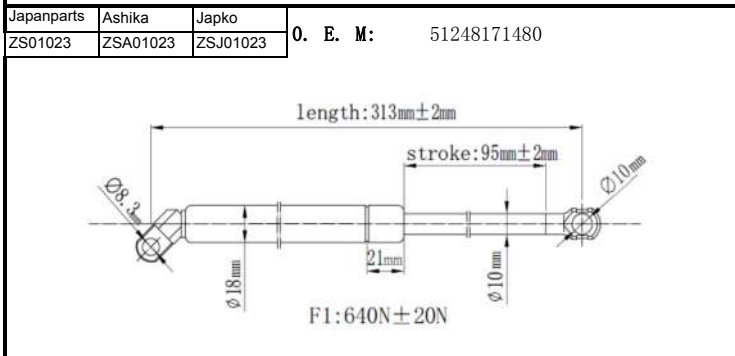
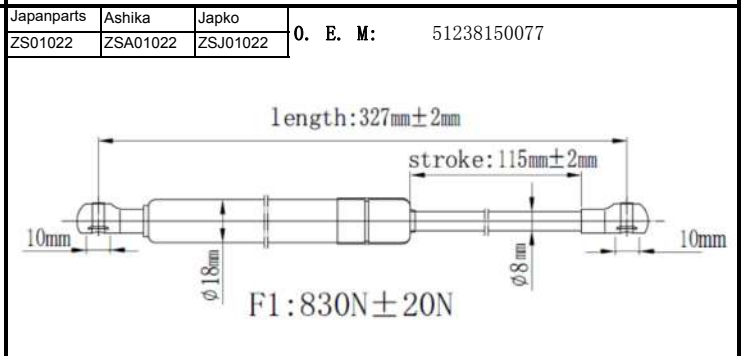
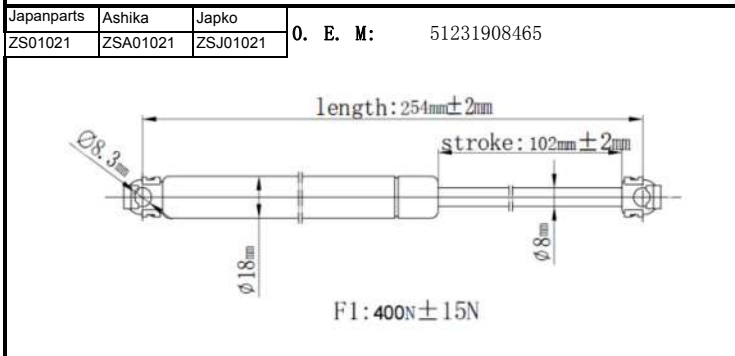
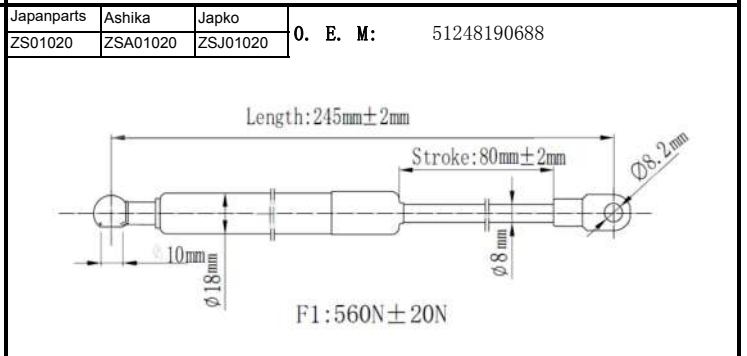
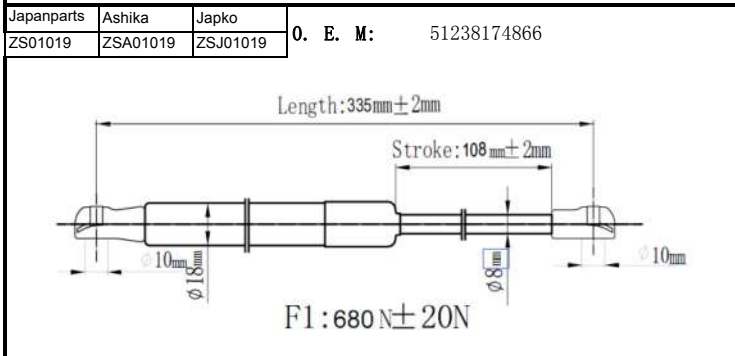
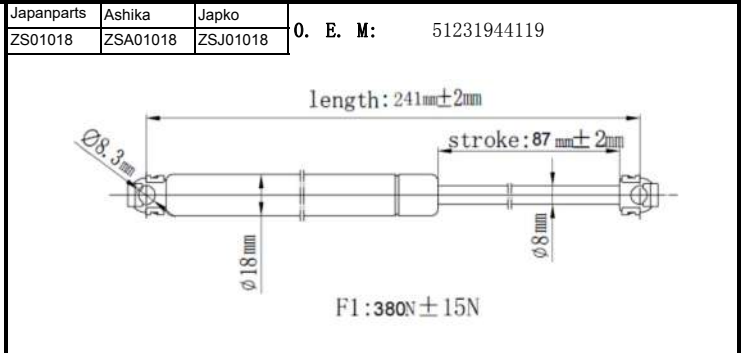
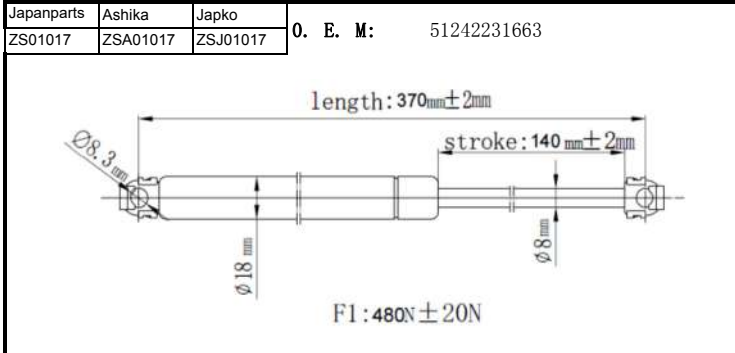
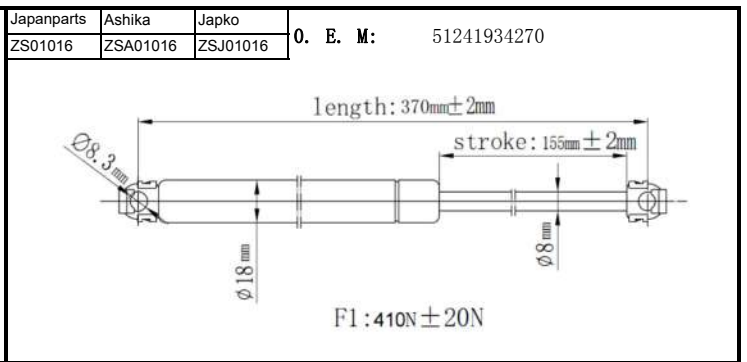
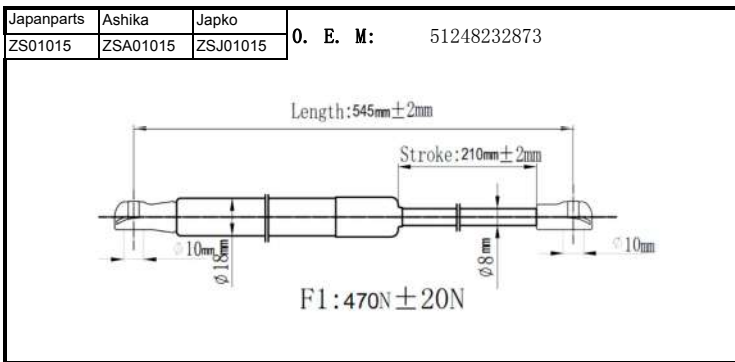

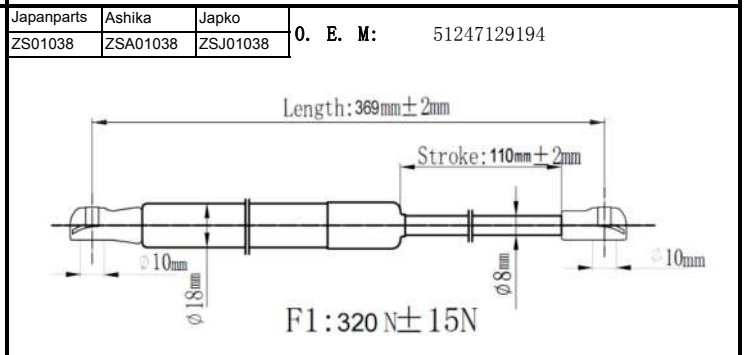
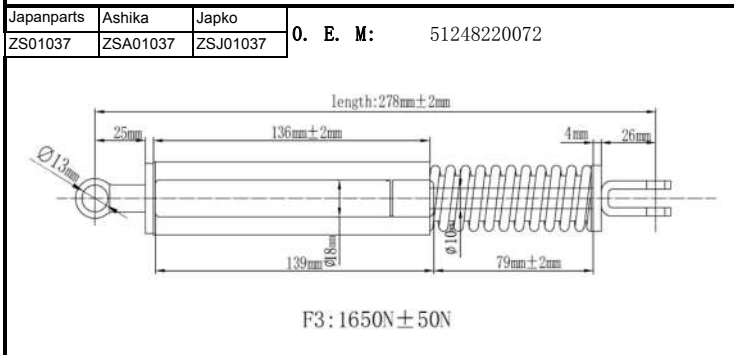
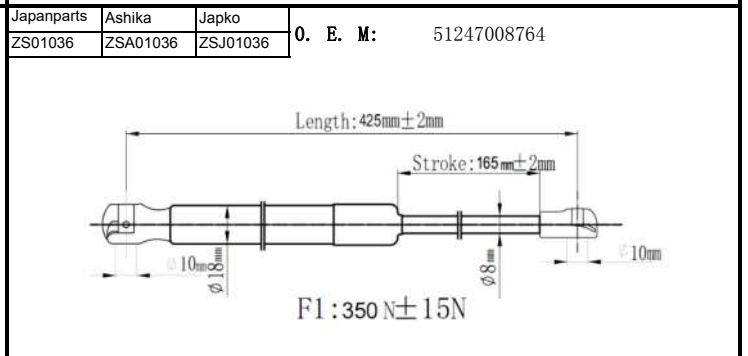
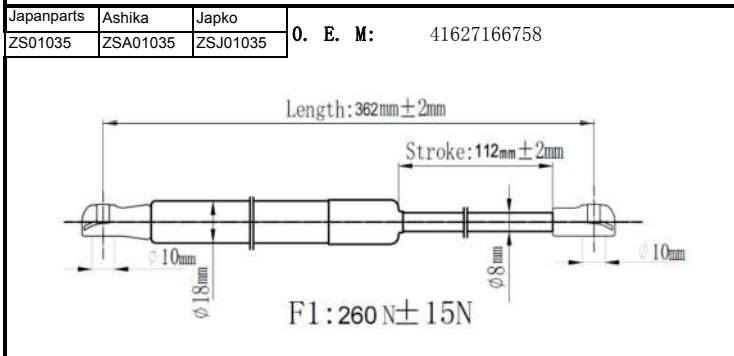
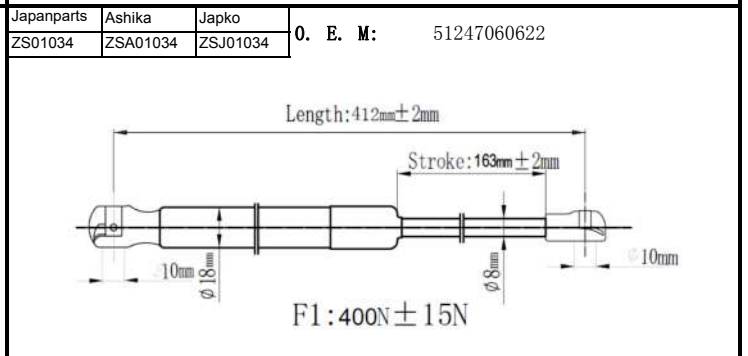
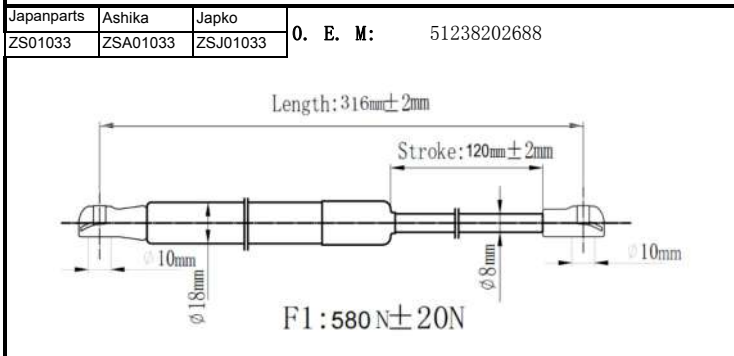
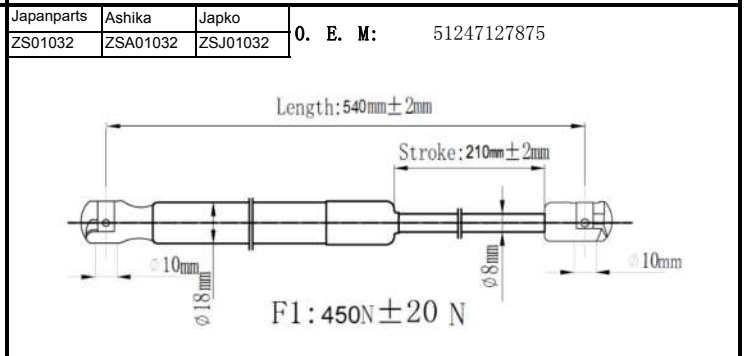
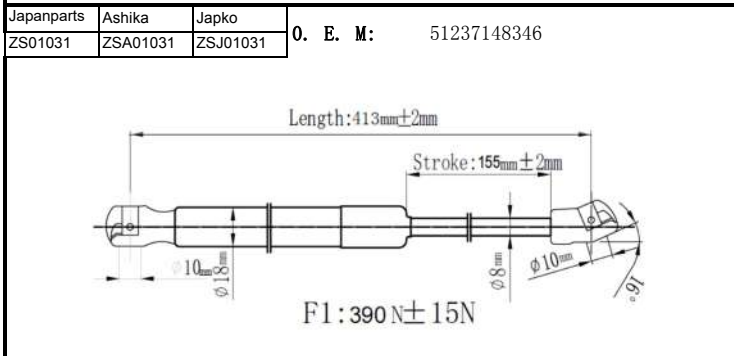
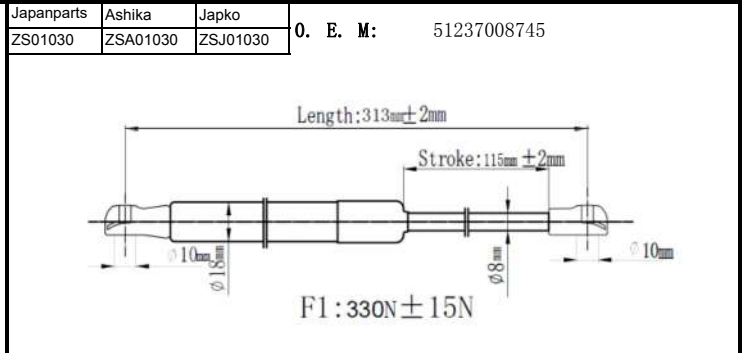
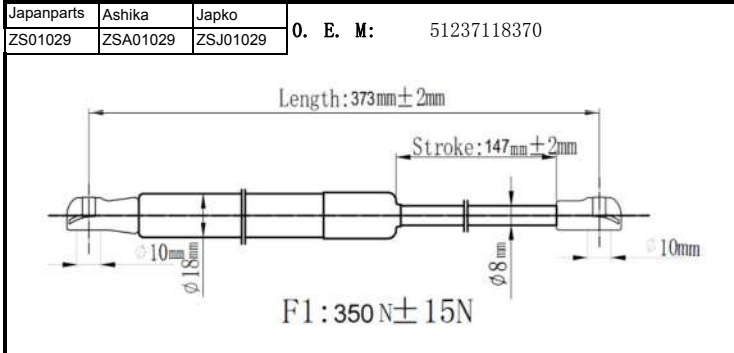
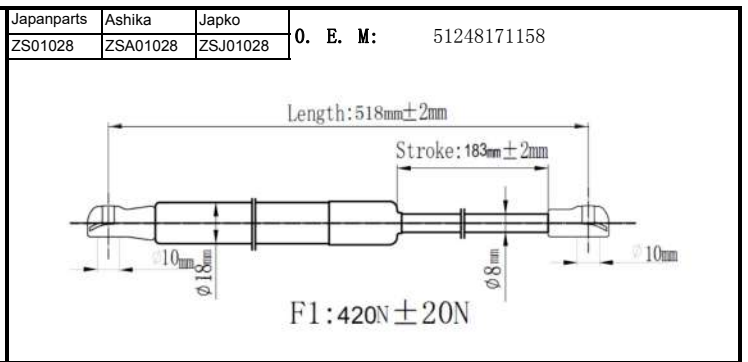
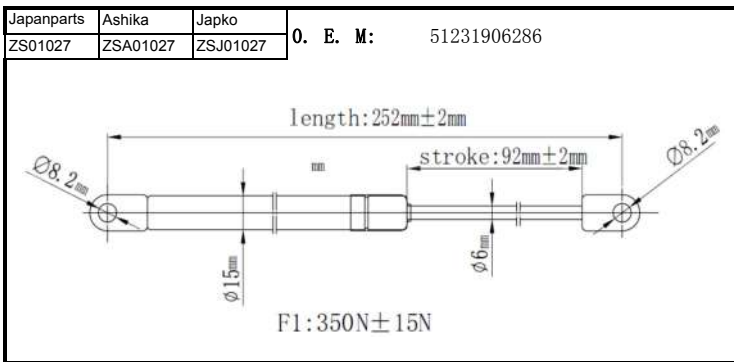

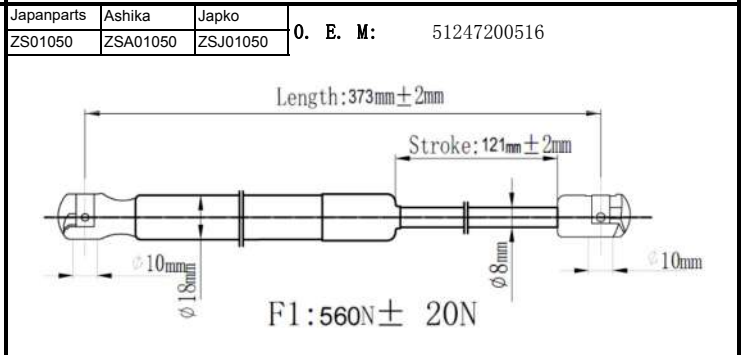
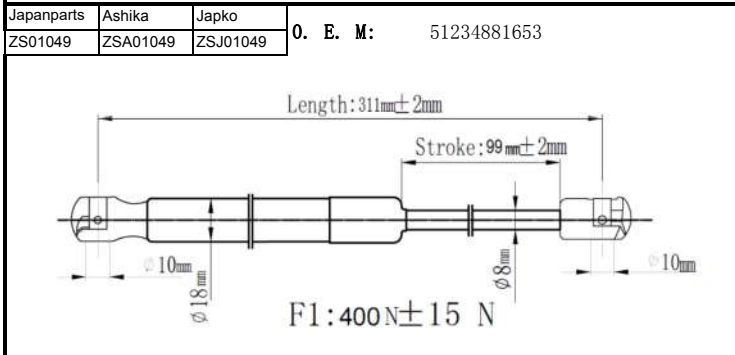
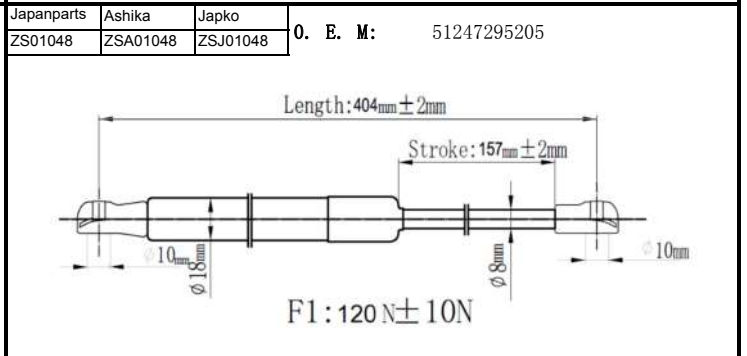
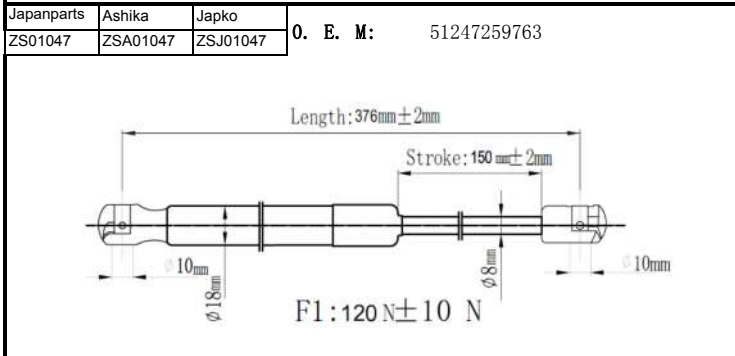
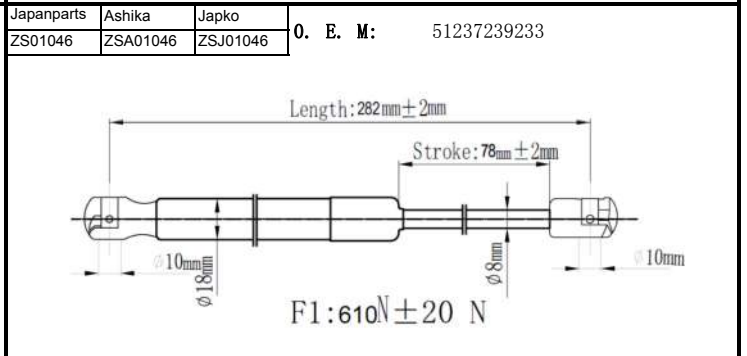
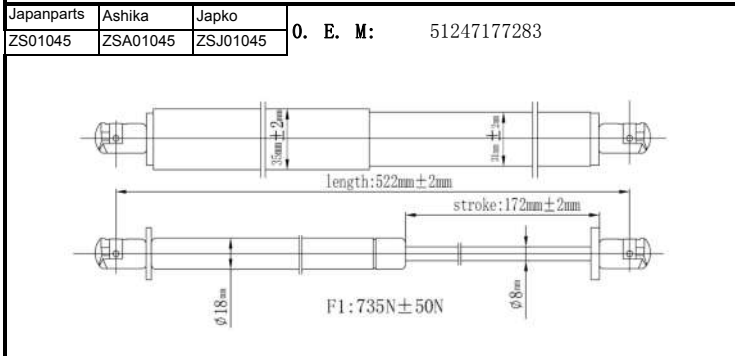
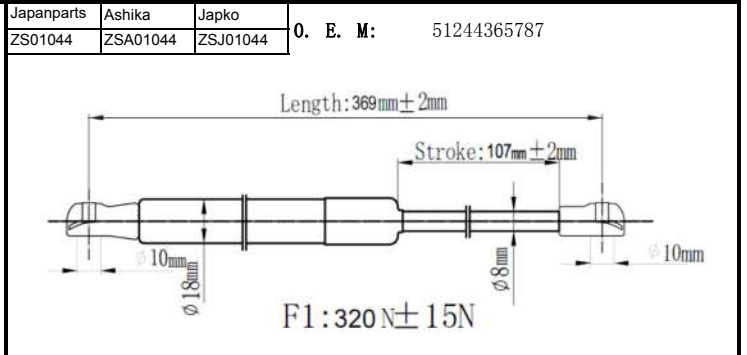
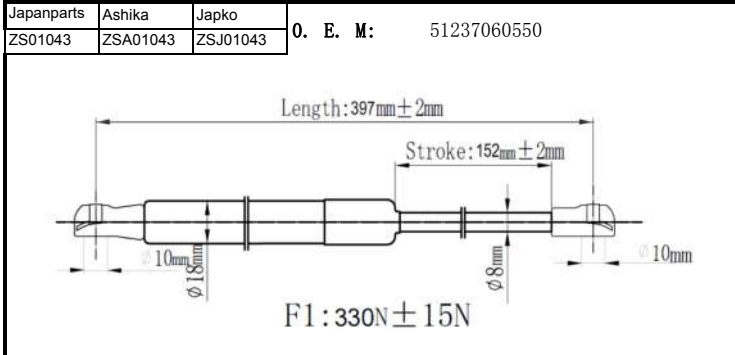
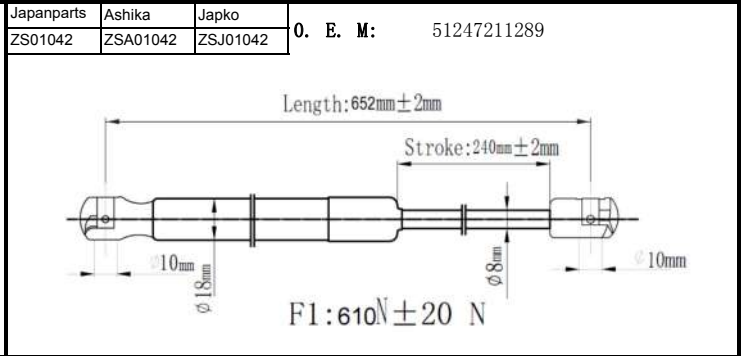
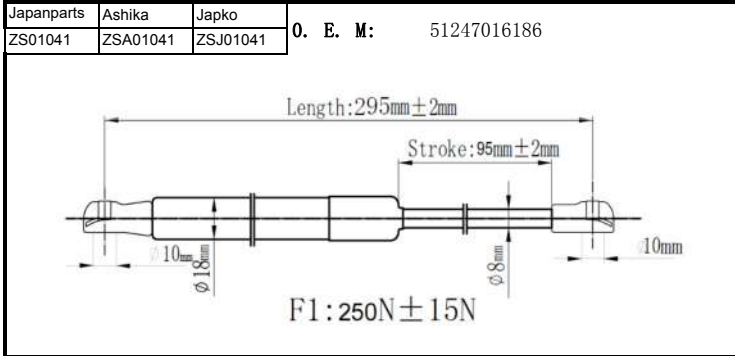
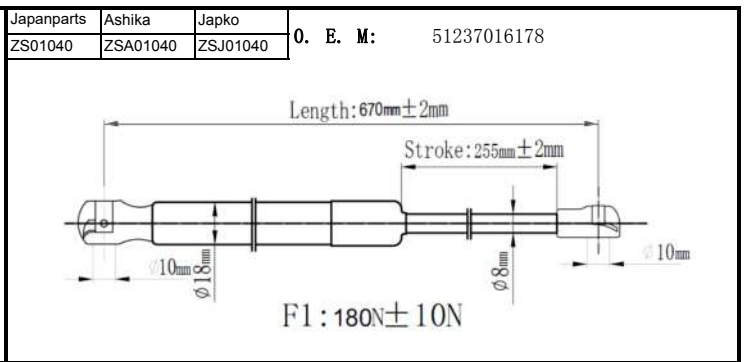
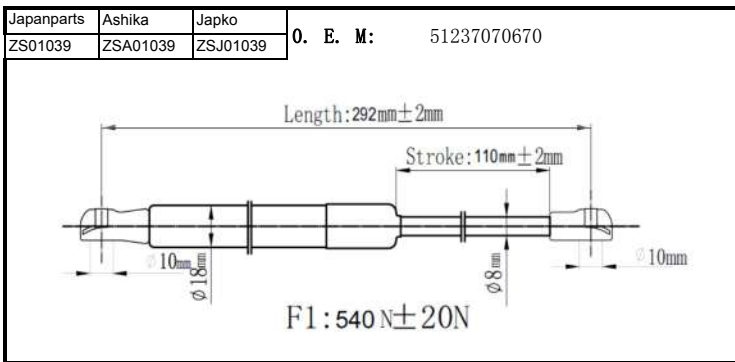

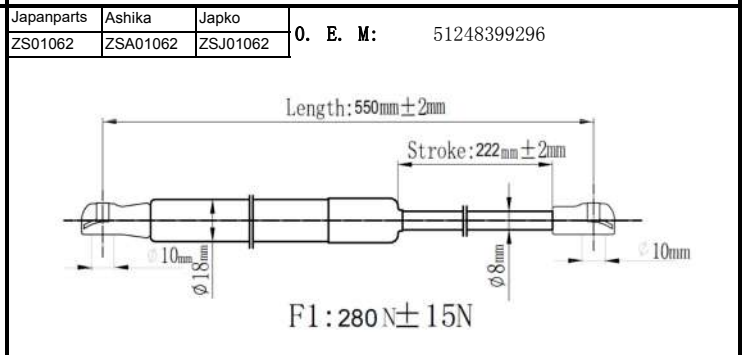
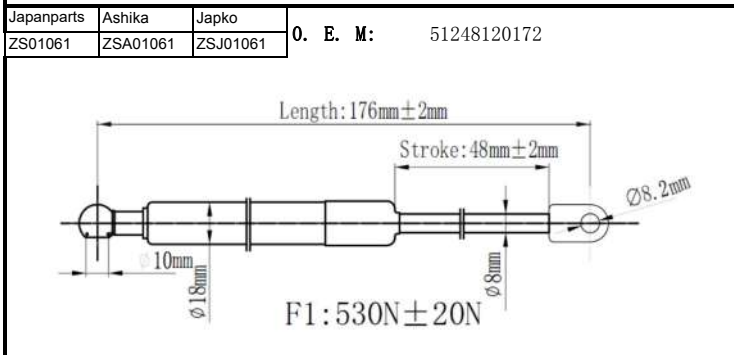
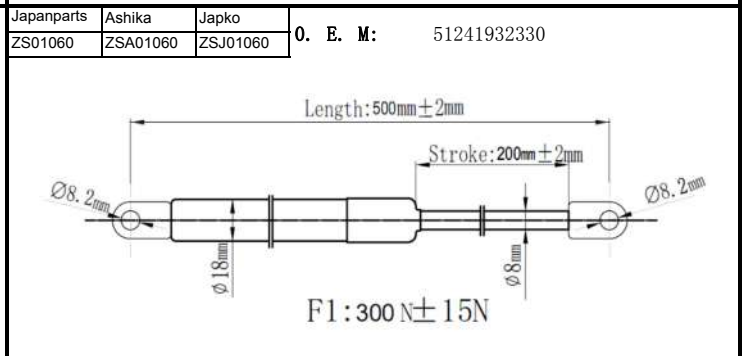
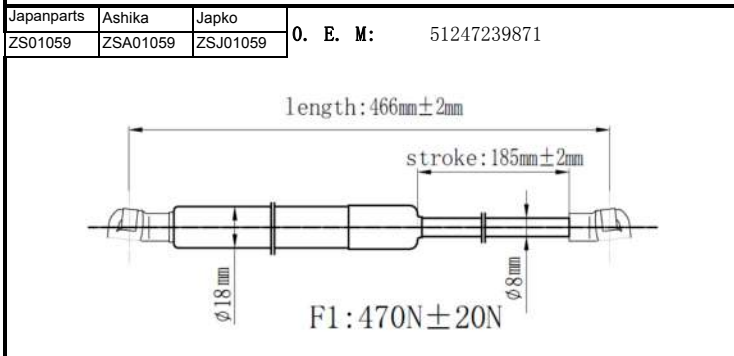
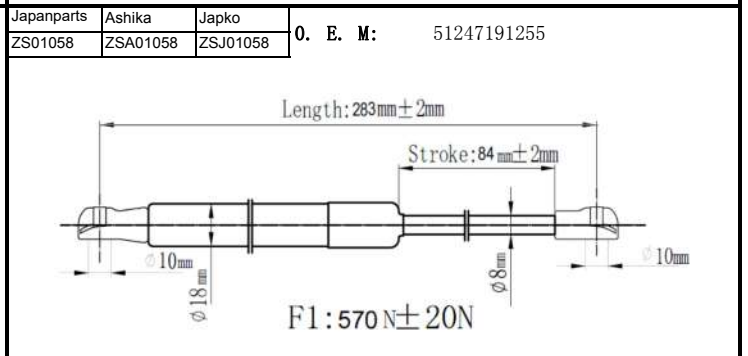
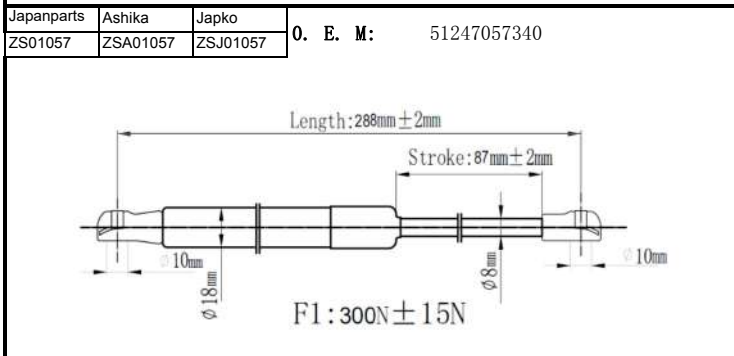
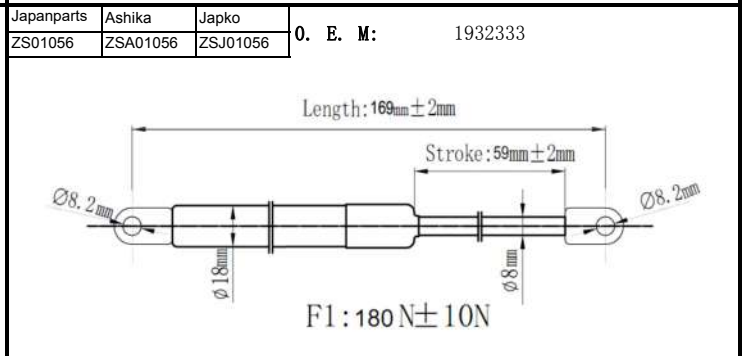
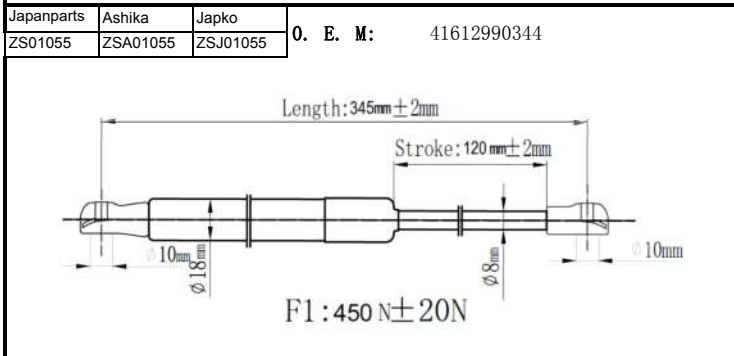
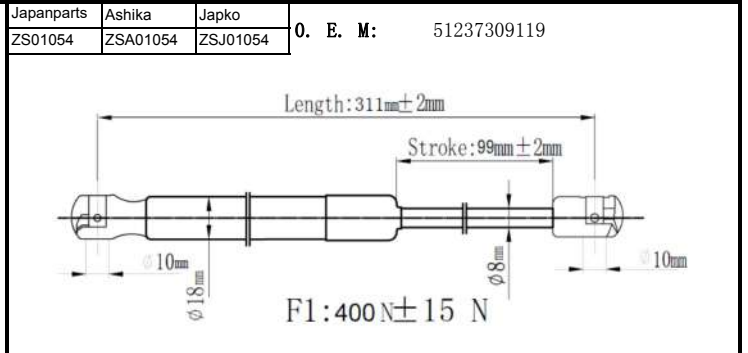
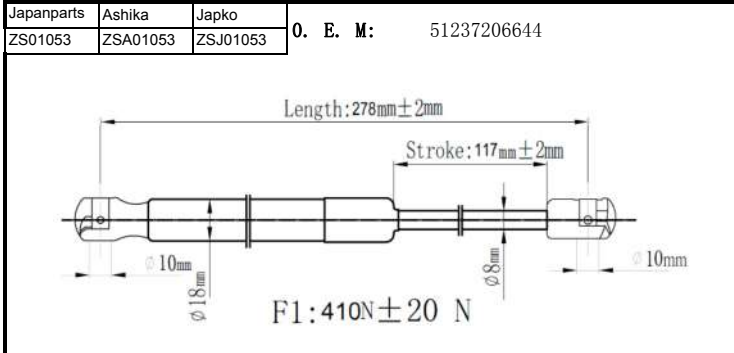
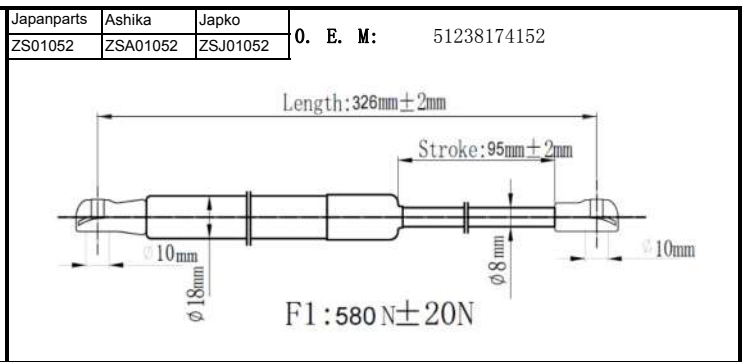
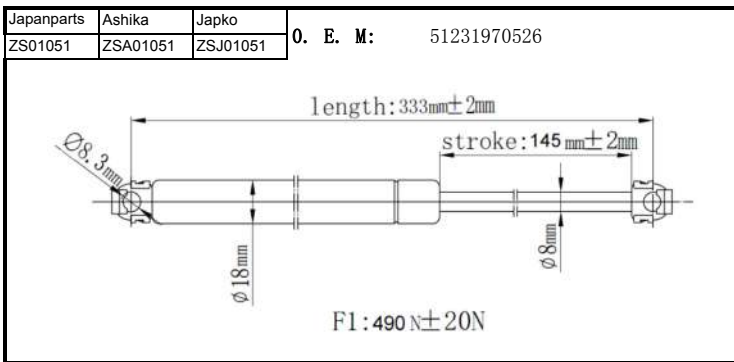

| | | |
|------------|----------|----------|
| Japanparts | Ashika | Japko |
| ZS01063 | ZSA01063 | ZSJ01063 |

O. E. M.: 51477148826

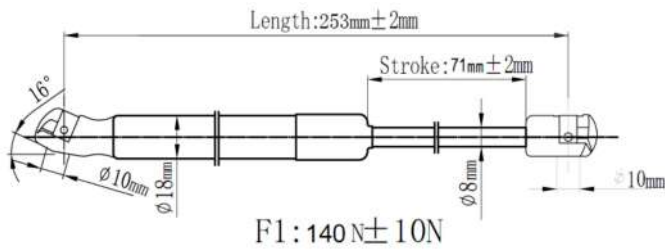

| | | |
|------------|----------|----------|
| Japanparts | Ashika | Japko |
| ZS01064 | ZSA01064 | ZSJ01064 |

O. E. M.: 51247178273

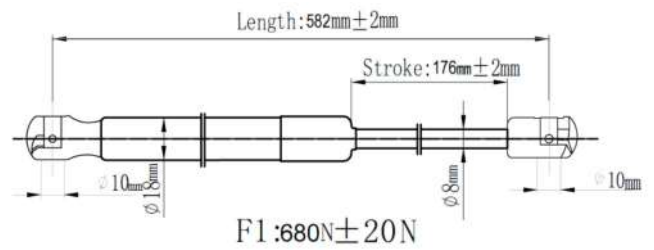

| | | |
|------------|----------|----------|
| Japanparts | Ashika | Japko |
| ZS01065 | ZSA01065 | ZSJ01065 |

O. E. M.: 54.31 - 8 268 980

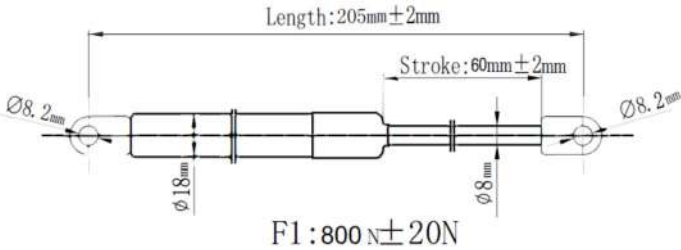

| | | |
|------------|----------|----------|
| Japanparts | Ashika | Japko |
| ZS01066 | ZSA01066 | ZSJ01066 |

O. E. M.: 51258227897

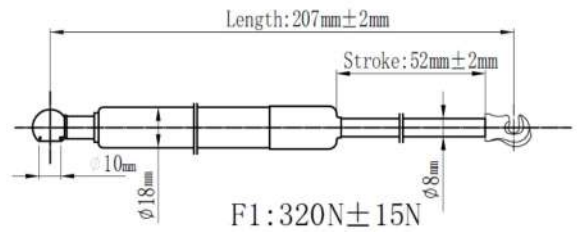

| | | |
|------------|----------|----------|
| Japanparts | Ashika | Japko |
| ZS01067 | ZSA01067 | ZSJ01067 |

O. E. M.: 54318232767

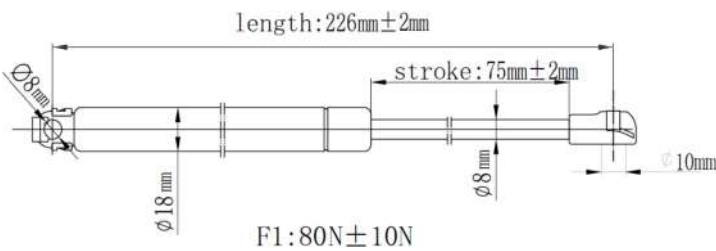

| | | |
|------------|----------|----------|
| Japanparts | Ashika | Japko |
| ZS01068 | ZSA01068 | ZSJ01068 |

O. E. M.: 1002092

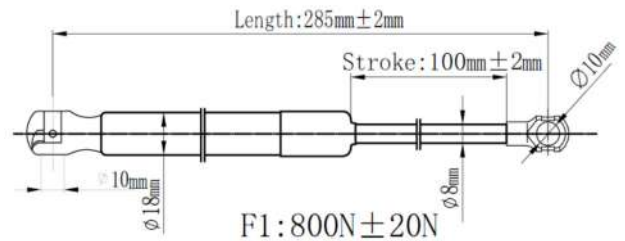

| | | |
|------------|----------|----------|
| Japanparts | Ashika | Japko |
| ZS01069 | ZSA01069 | ZSJ01069 |

O. E. M.: 51237289752

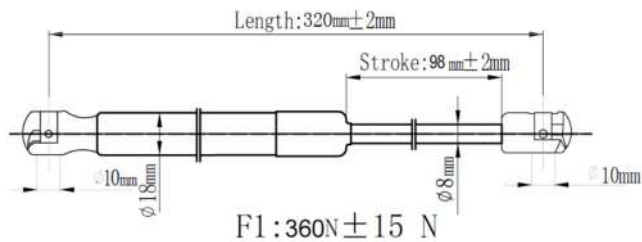

| | | |
|------------|----------|----------|
| Japanparts | Ashika | Japko |
| ZS01070 | ZSA01070 | ZSJ01070 |

O. E. M.: 51231868555

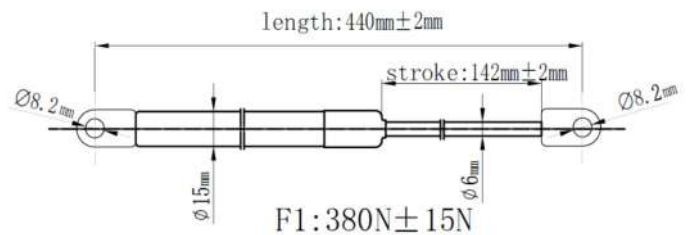

| | | |
|------------|----------|----------|
| Japanparts | Ashika | Japko |
| ZS01071 | ZSA01071 | ZSJ01071 |

O. E. M.: 3400379

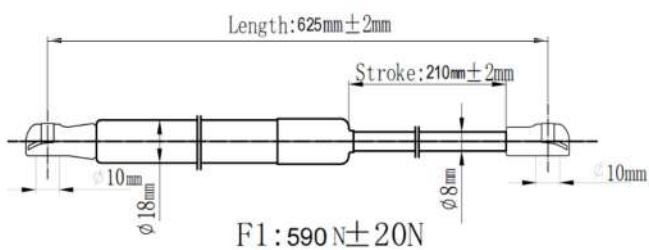

| | | |
|------------|----------|----------|
| Japanparts | Ashika | Japko |
| ZS01072 | ZSA01072 | ZSJ01072 |

O. E. M.: 51248222913

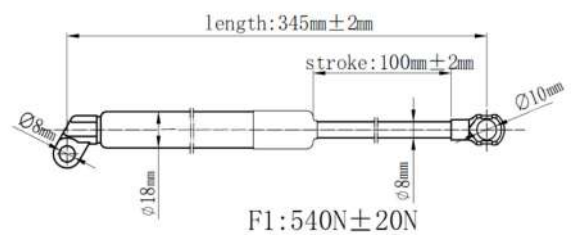

| | | |
|------------|----------|----------|
| Japanparts | Ashika | Japko |
| ZS01073 | ZSA01073 | ZSJ01073 |

O. E. M.: 51247038248

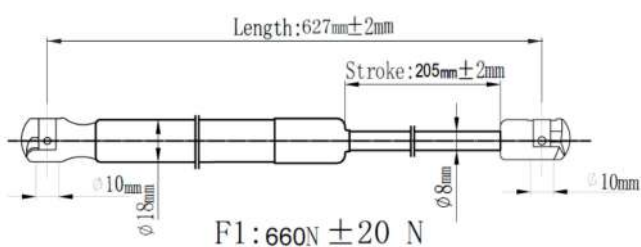

| | | |
|------------|----------|----------|
| Japanparts | Ashika | Japko |
| ZS01074 | ZSA01074 | ZSJ01074 |

O. E. M.: 51237210727

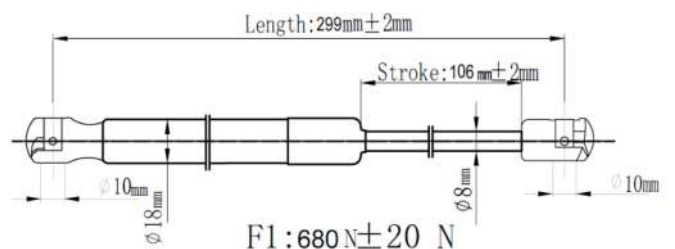

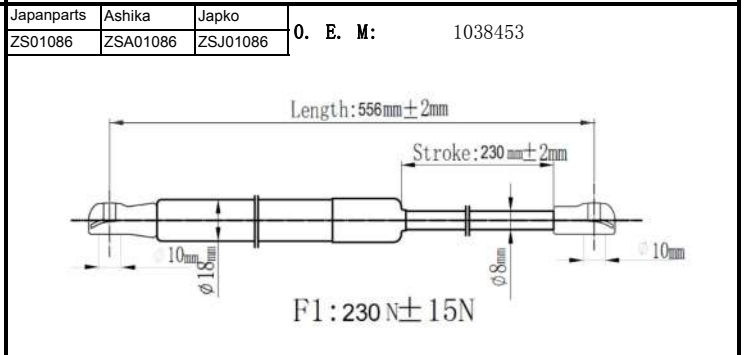
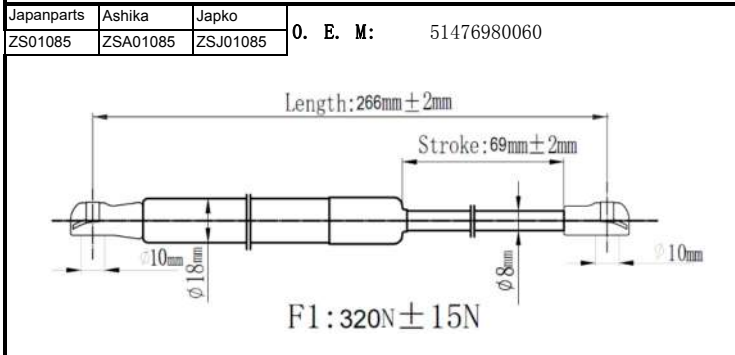
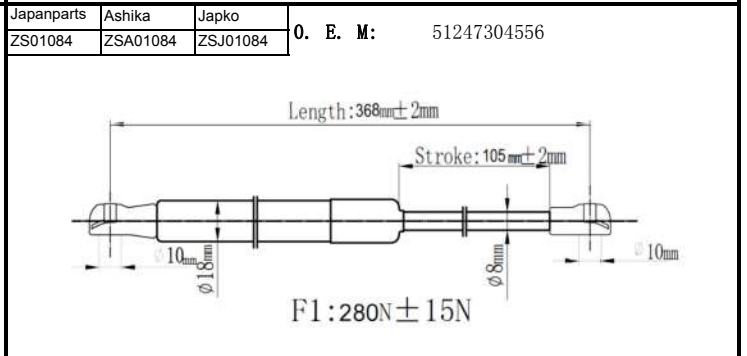
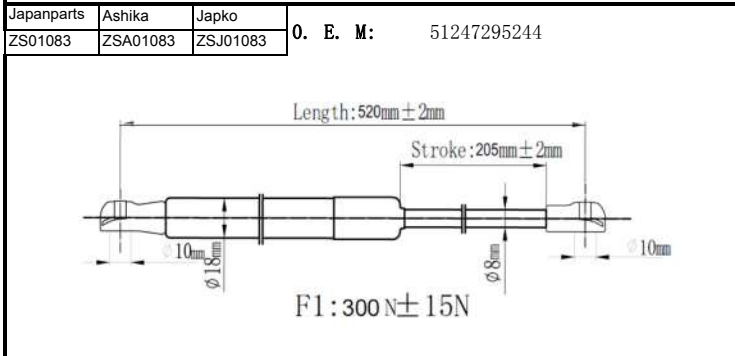
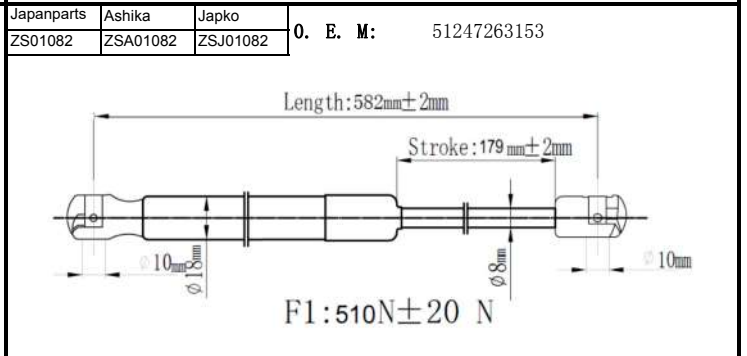
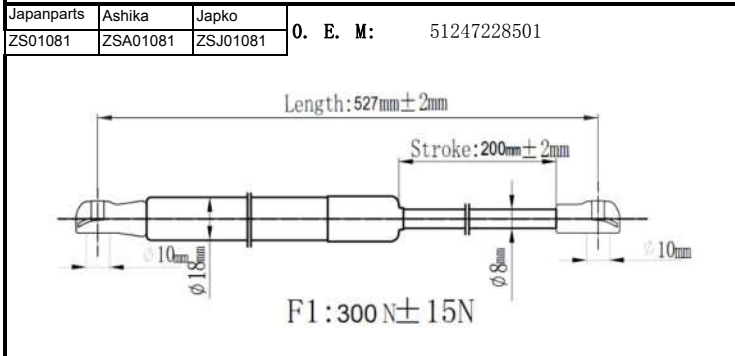
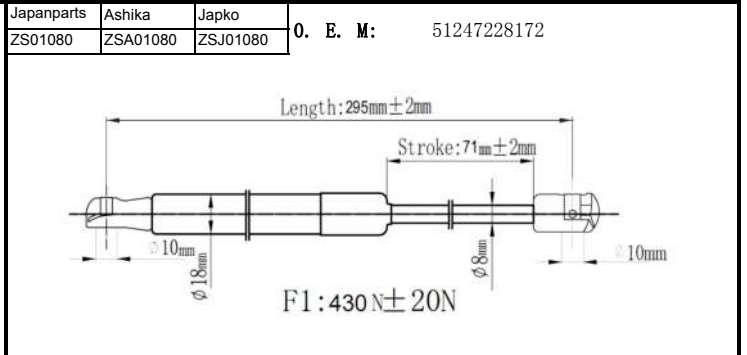
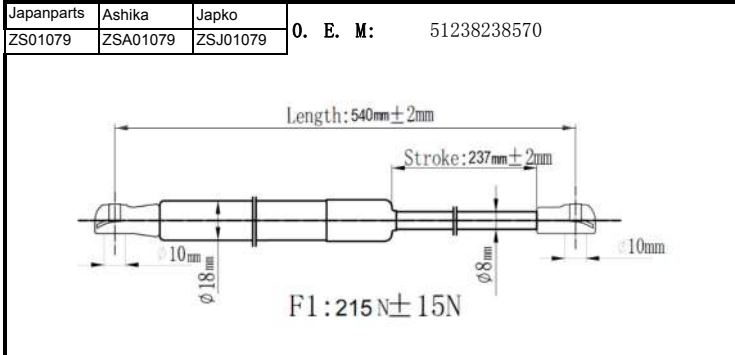
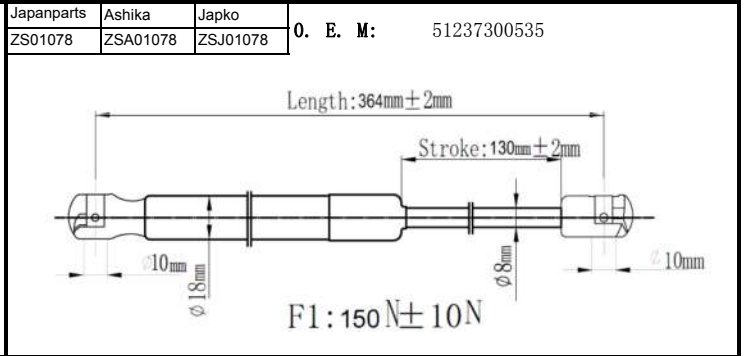
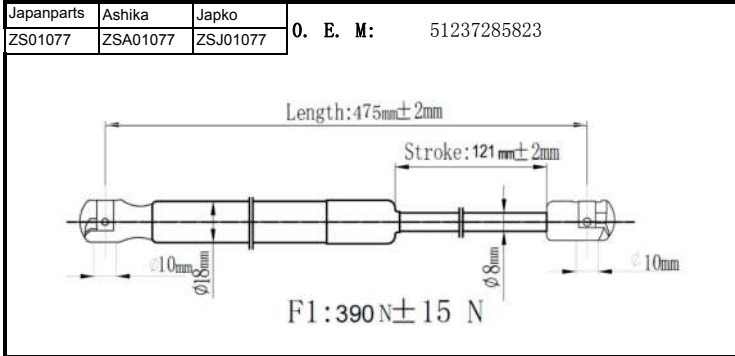
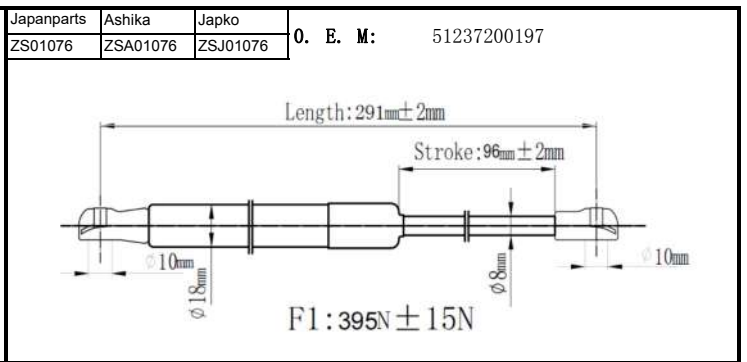
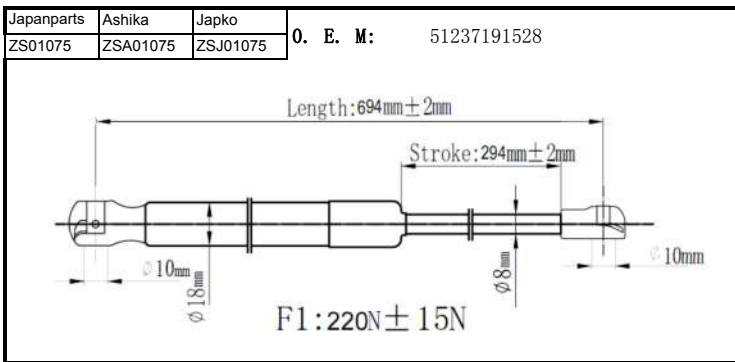

| | | |
|------------|----------|----------|
| Japanparts | Ashika | Japko |
| ZS01087 | ZSA01087 | ZSJ01087 |

O. E. M.: 41626801258

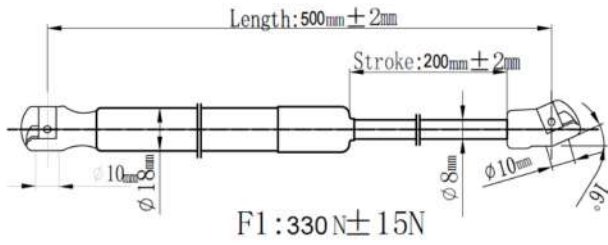

| | | |
|------------|----------|----------|
| Japanparts | Ashika | Japko |
| ZS01088 | ZSA01088 | ZSJ01088 |

O. E. M.: 41616801259

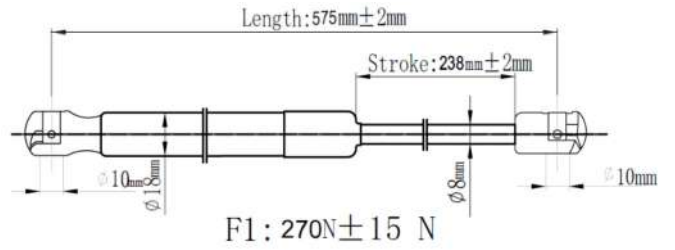

| | | |
|------------|----------|----------|
| Japanparts | Ashika | Japko |
| ZS01089 | ZSA01089 | ZSJ01089 |

O. E. M.: 51249801386

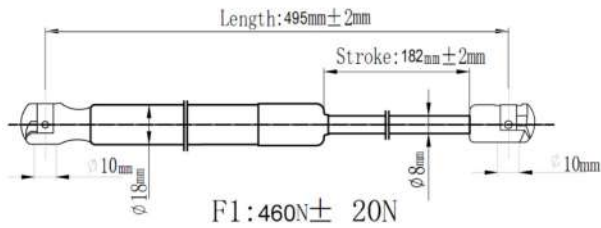

| | | |
|------------|----------|----------|
| Japanparts | Ashika | Japko |
| ZS01090 | ZSA01090 | ZSJ01090 |

O. E. M.: 51242758742

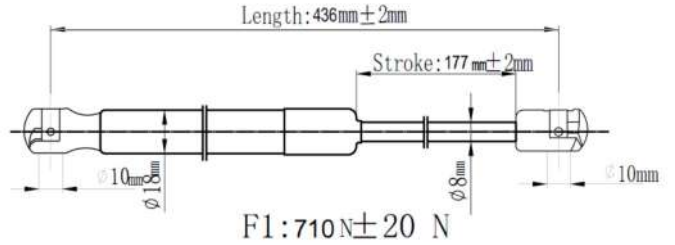

| | | |
|------------|----------|----------|
| Japanparts | Ashika | Japko |
| ZS01091 | ZSA01091 | ZSJ01091 |

O. E. M.: 51247167442

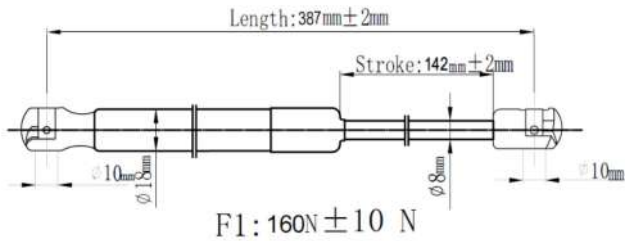

| | | |
|------------|----------|----------|
| Japanparts | Ashika | Japko |
| ZS01092 | ZSA01092 | ZSJ01092 |

O. E. M.: 51237148864

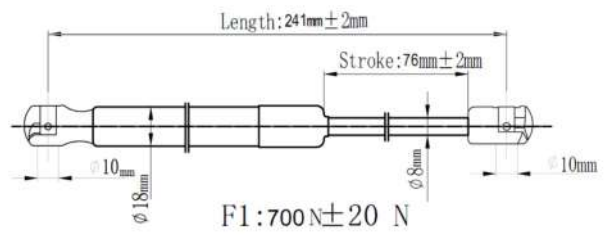

| | | |
|------------|----------|----------|
| Japanparts | Ashika | Japko |
| ZS01093 | ZSA01093 | ZSJ01093 |

O. E. M.: 51247148902

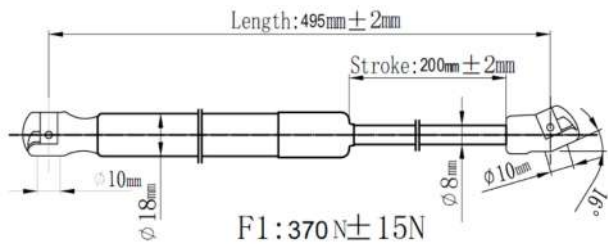

| | | |
|------------|----------|----------|
| Japanparts | Ashika | Japko |
| ZS01094 | ZSA01094 | ZSJ01094 |

O. E. M.: 51242759034

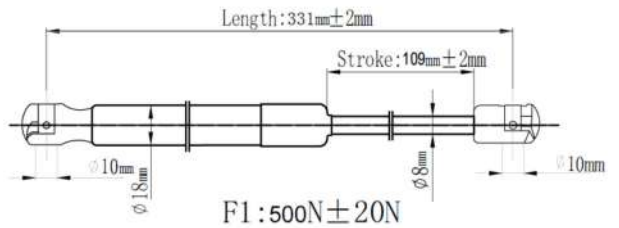

| | | |
|------------|----------|----------|
| Japanparts | Ashika | Japko |
| ZS01095 | ZSA01095 | ZSJ01095 |

O. E. M.: 51239802054

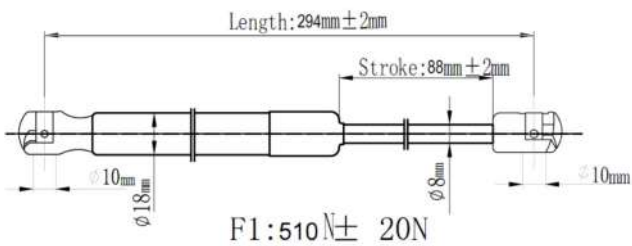

| | | |
|------------|----------|----------|
| Japanparts | Ashika | Japko |
| ZS01096 | ZSA01096 | ZSJ01096 |

O. E. M.: 51249808987

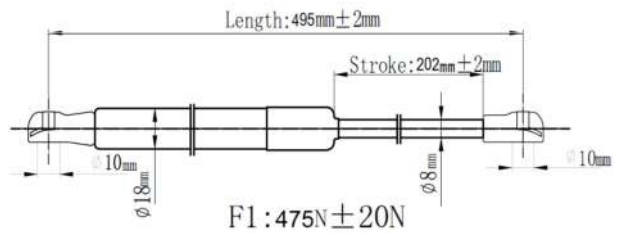

| | | |
|------------|----------|----------|
| Japanparts | Ashika | Japko |
| ZS01098 | ZSA01098 | ZSJ01098 |

O. E. M.: 51247497482

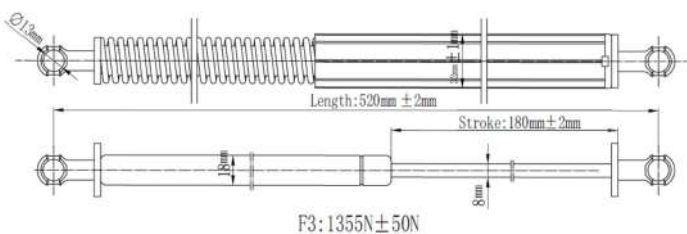

| | | |
|------------|----------|----------|
| Japanparts | Ashika | Japko |
| ZS01099 | ZSA01099 | ZSJ01099 |

O. E. M.: 51247366403

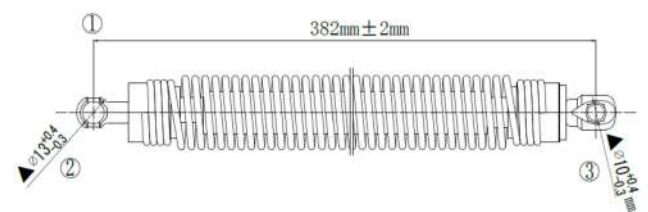

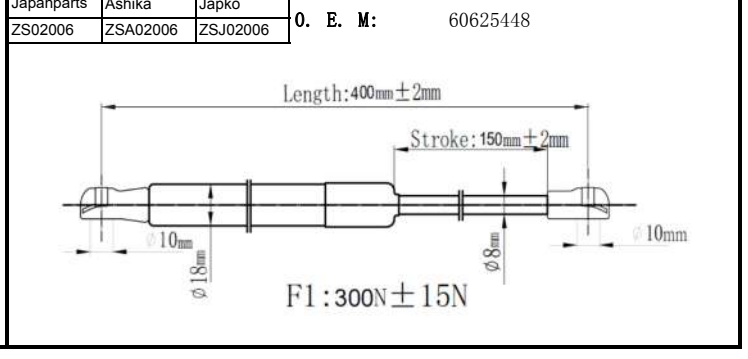
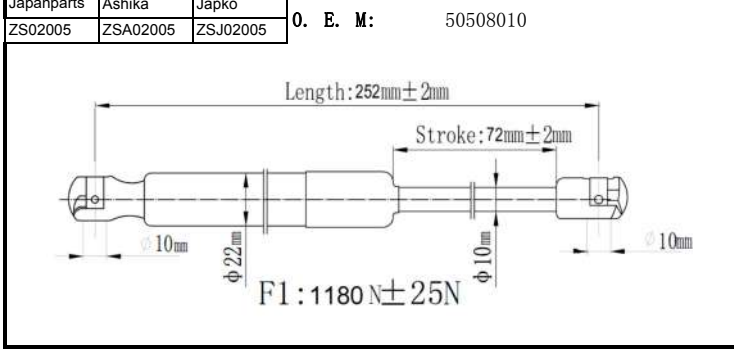
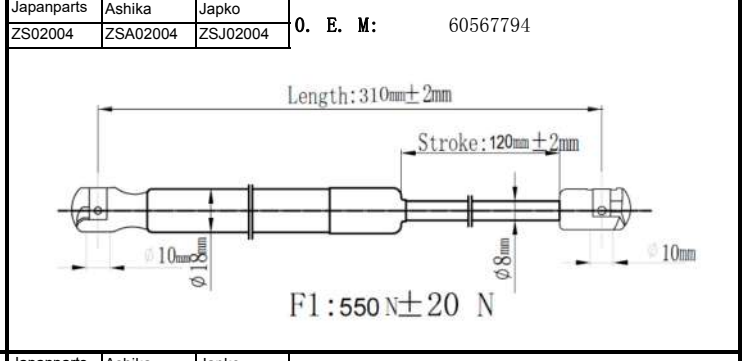
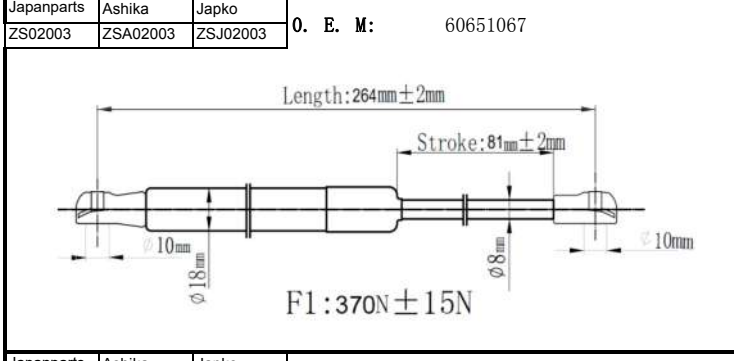
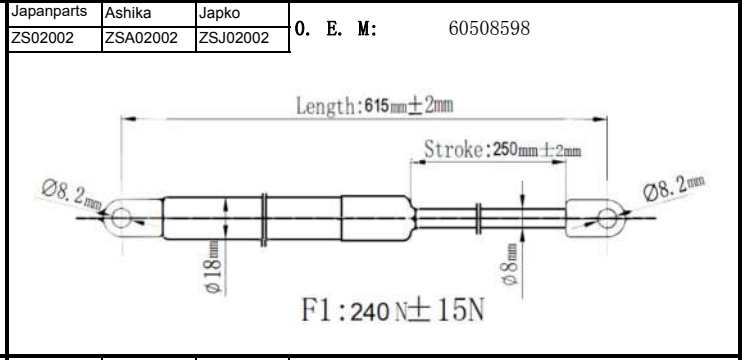
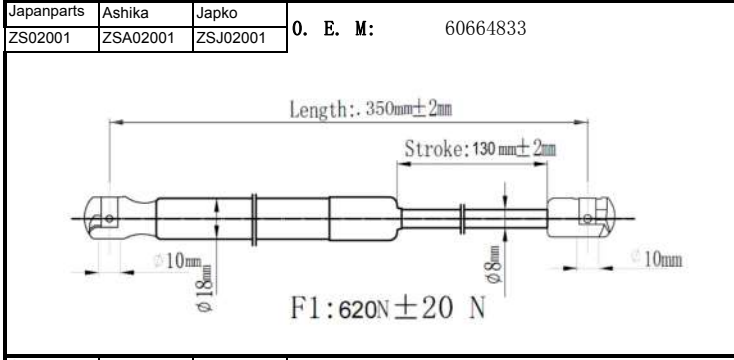
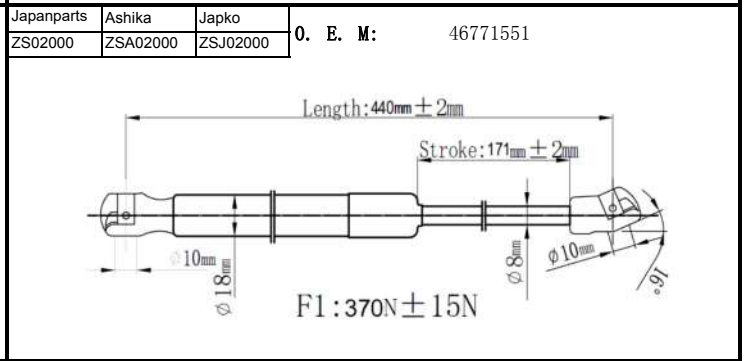
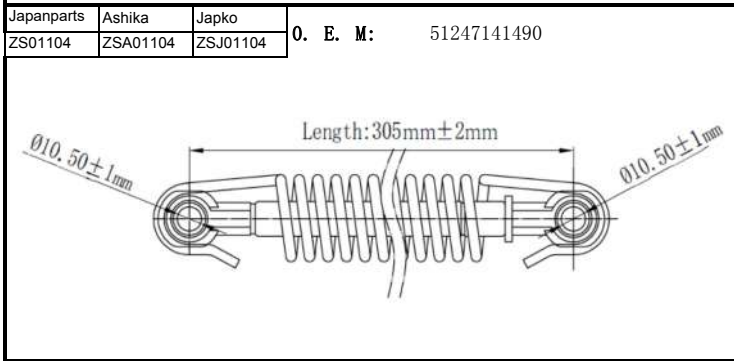
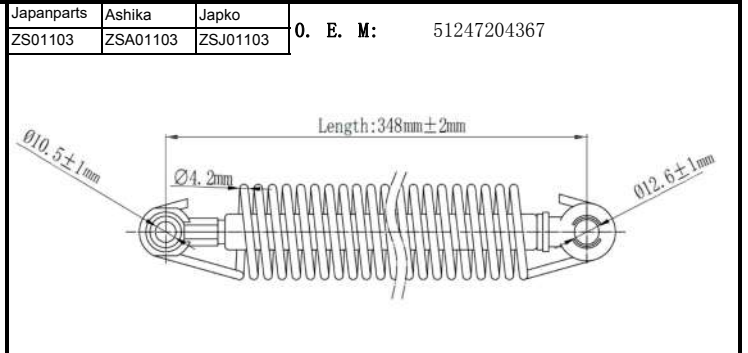
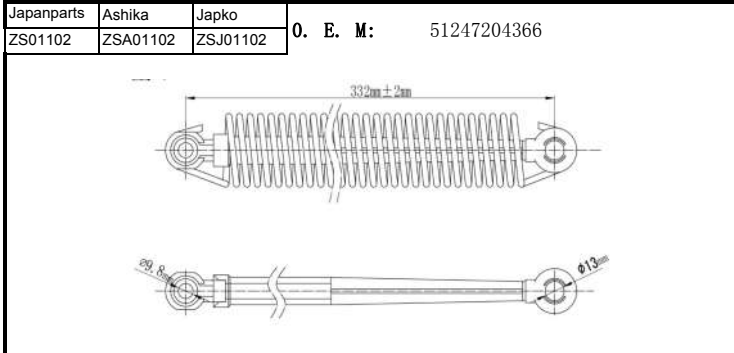
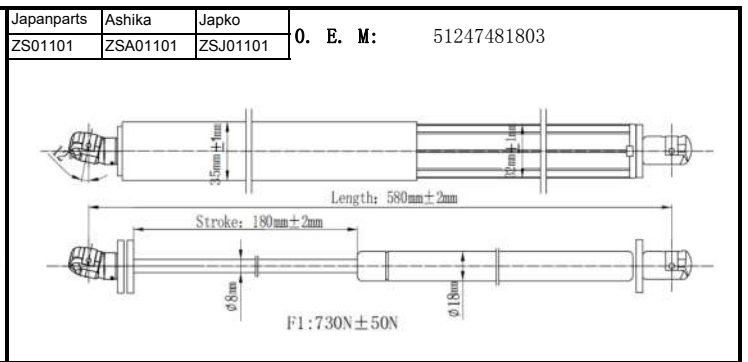
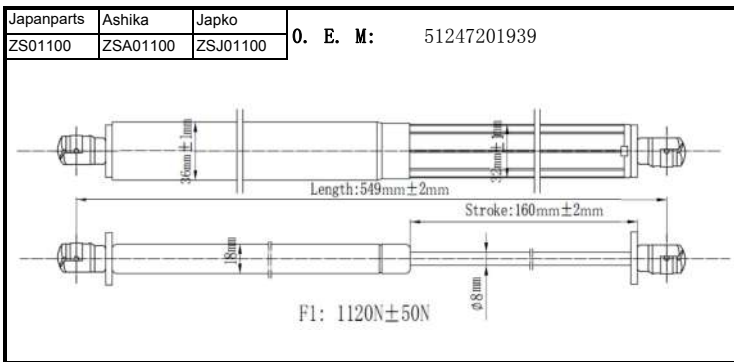

| | | |
|------------|----------|----------|
| Japanparts | Ashika | Japko |
| ZS02007 | ZSA02007 | ZSJ02007 |

O. E. M.: 60694616

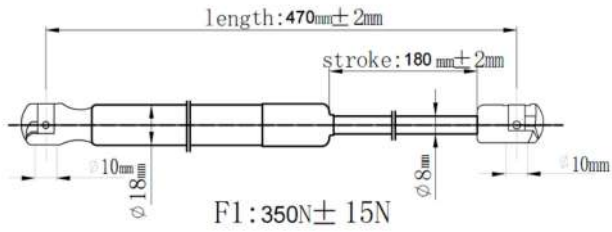

| | | |
|------------|----------|----------|
| Japanparts | Ashika | Japko |
| ZS02008 | ZSA02008 | ZSJ02008 |

O. E. M.: 60596879

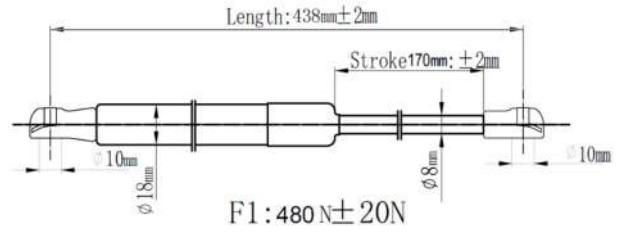

| | | |
|------------|----------|----------|
| Japanparts | Ashika | Japko |
| ZS02009 | ZSA02009 | ZSJ02009 |

O. E. M.: 50515442

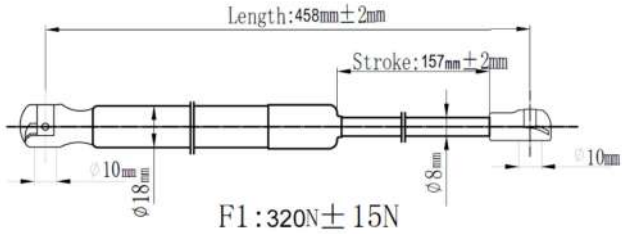

| | | |
|------------|----------|----------|
| Japanparts | Ashika | Japko |
| ZS02010 | ZSA02010 | ZSJ02010 |

O. E. M.: 60694168

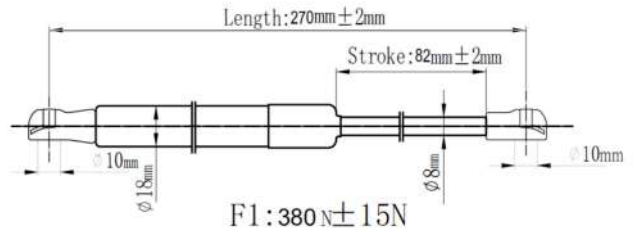

| | | |
|------------|----------|----------|
| Japanparts | Ashika | Japko |
| ZS02011 | ZSA02011 | ZSJ02011 |

O. E. M.: 60688574

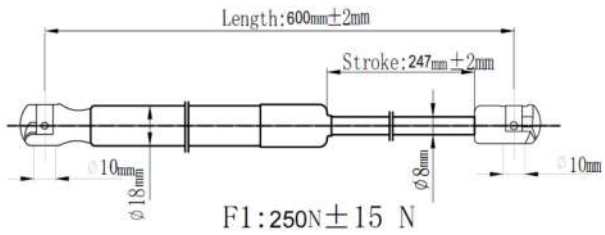

| | | |
|------------|----------|----------|
| Japanparts | Ashika | Japko |
| ZS02012 | ZSA02012 | ZSJ02012 |

O. E. M.: 50509830

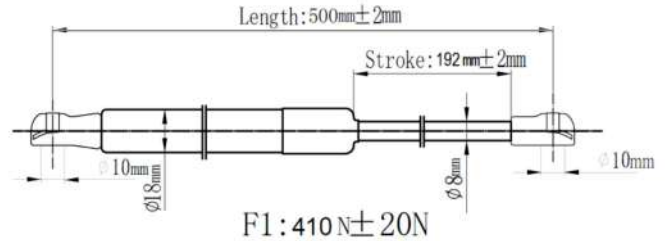

| | | |
|------------|----------|----------|
| Japanparts | Ashika | Japko |
| ZS02013 | ZSA02013 | ZSJ02013 |

O. E. M.: 60594694

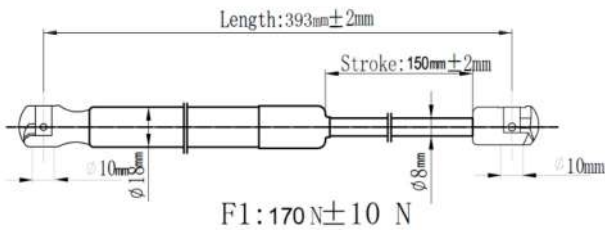

| | | |
|------------|----------|----------|
| Japanparts | Ashika | Japko |
| ZS02014 | ZSA02014 | ZSJ02014 |

O. E. M.: 60577413

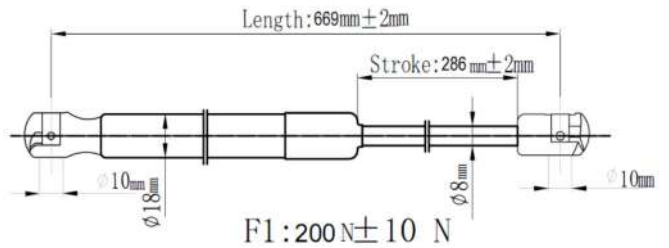

| | | |
|------------|----------|----------|
| Japanparts | Ashika | Japko |
| ZS02015 | ZSA02015 | ZSJ02015 |

O. E. M.: 60567383

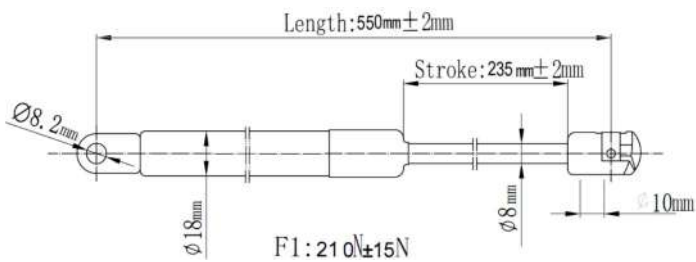

| | | |
|------------|----------|----------|
| Japanparts | Ashika | Japko |
| ZS02016 | ZSA02016 | ZSJ02016 |

O. E. M.: 60604823

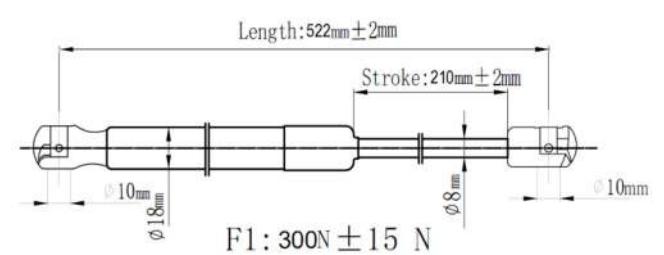

| | | |
|------------|----------|----------|
| Japanparts | Ashika | Japko |
| ZS02017 | ZSA02017 | ZSJ02017 |

O. E. M.: 60630457

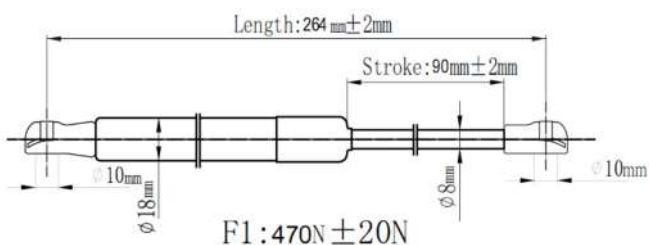

| | | |
|------------|----------|----------|
| Japanparts | Ashika | Japko |
| ZS02018 | ZSA02018 | ZSJ02018 |

O. E. M.: 60701106

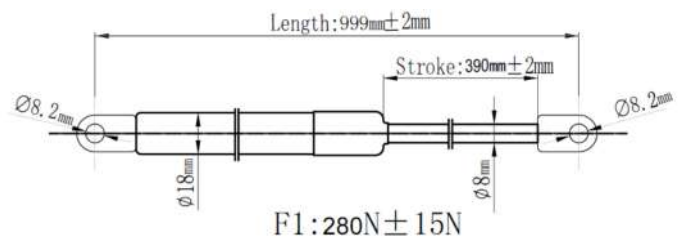

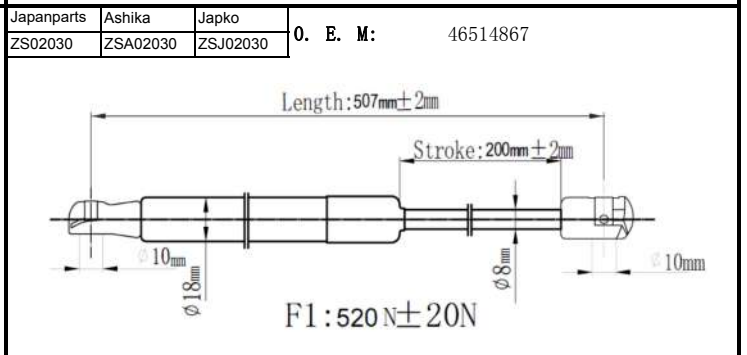
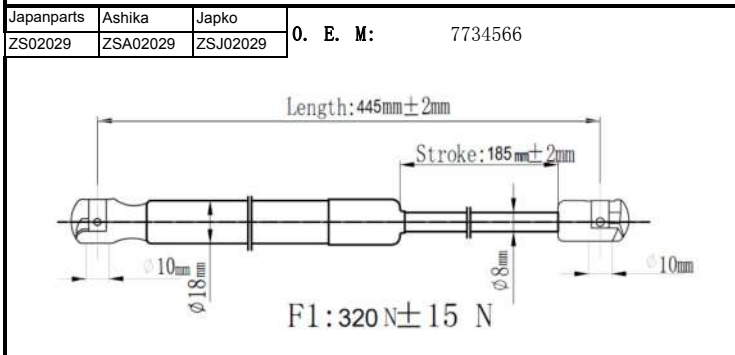
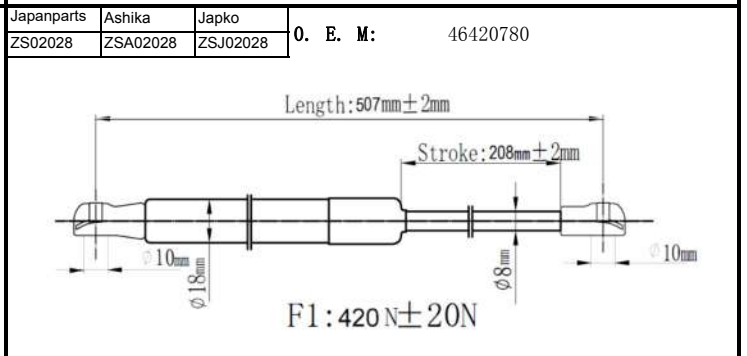
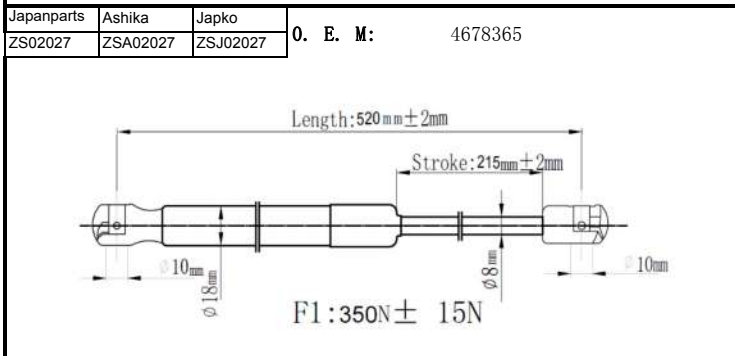
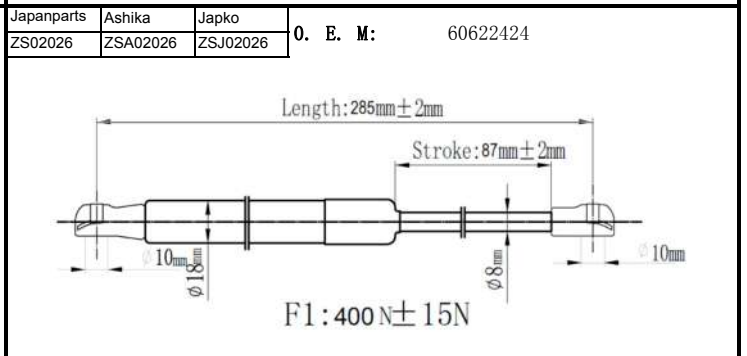
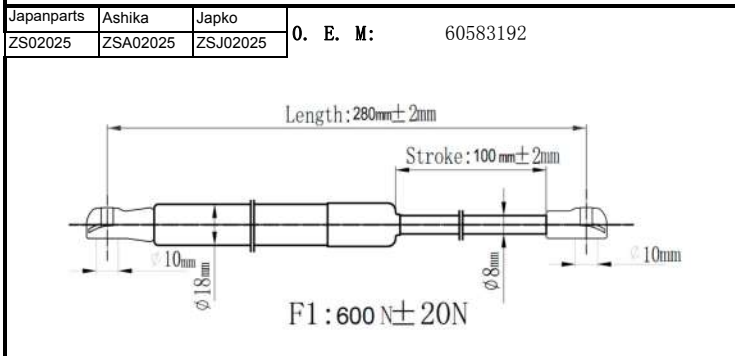
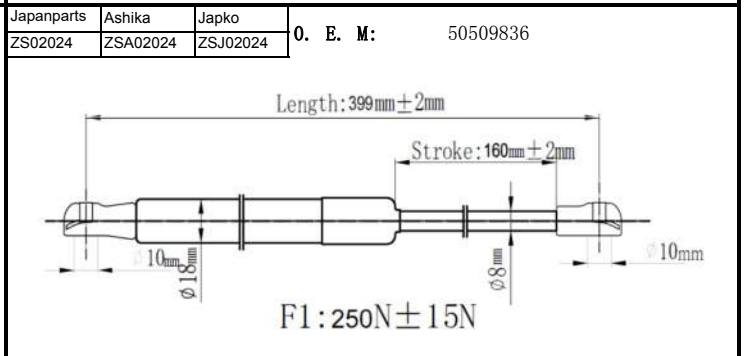
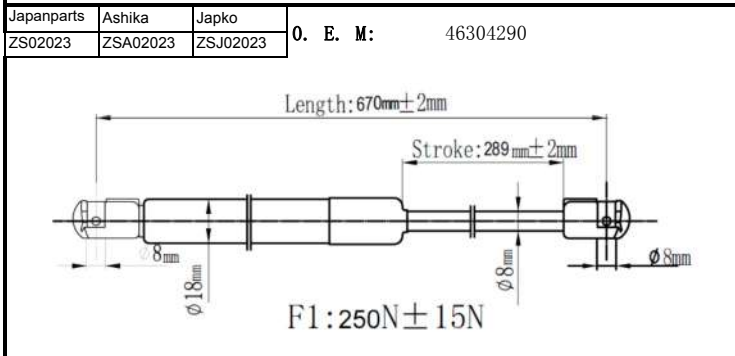
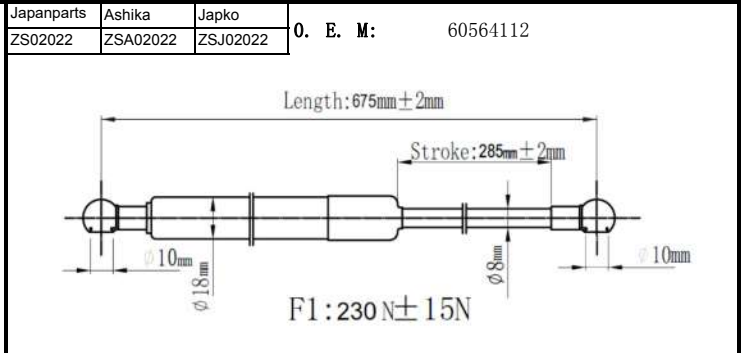
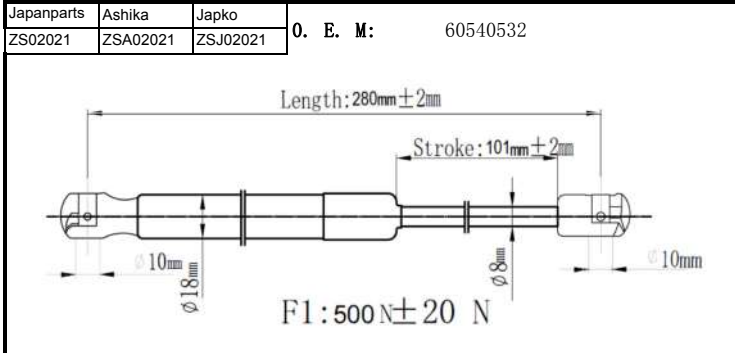
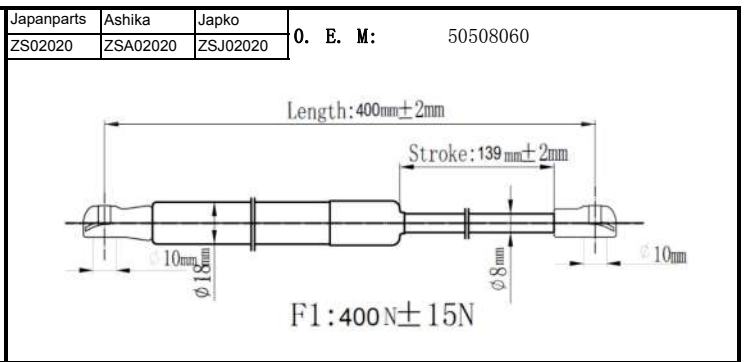
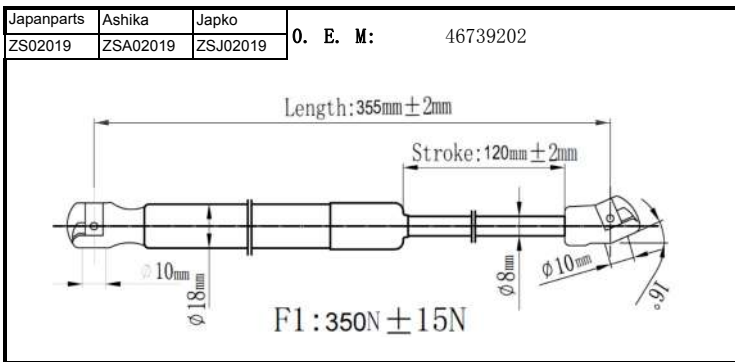

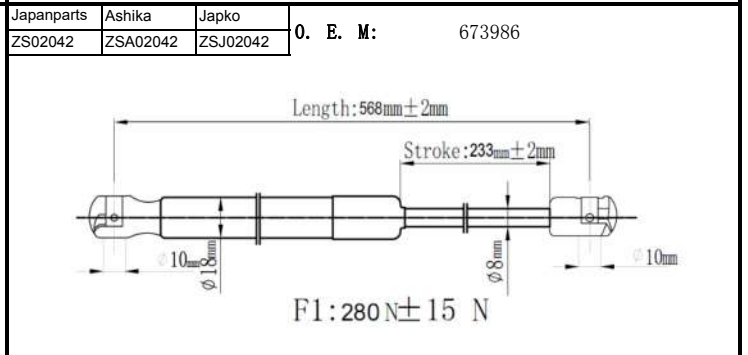
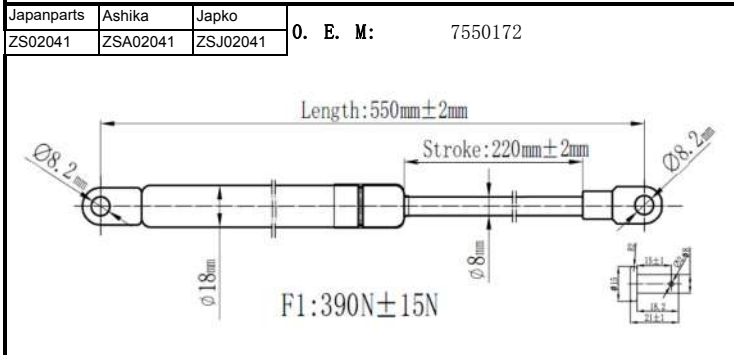
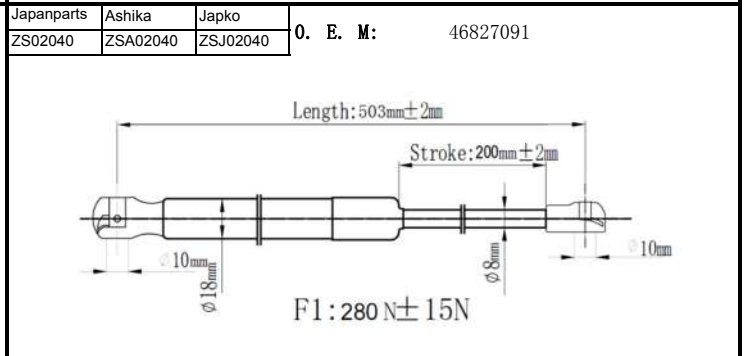
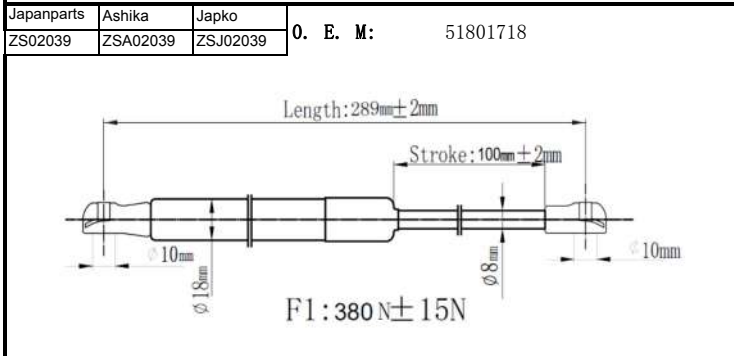
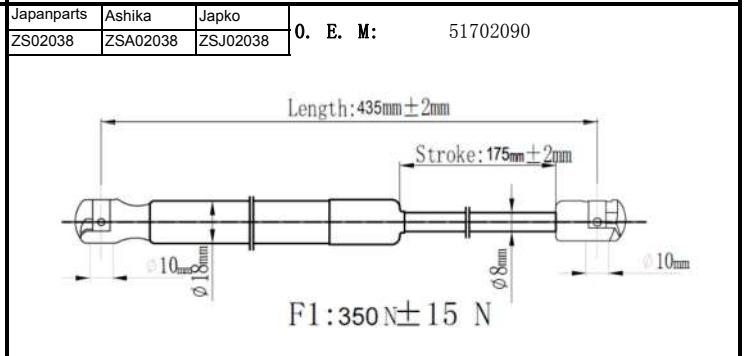
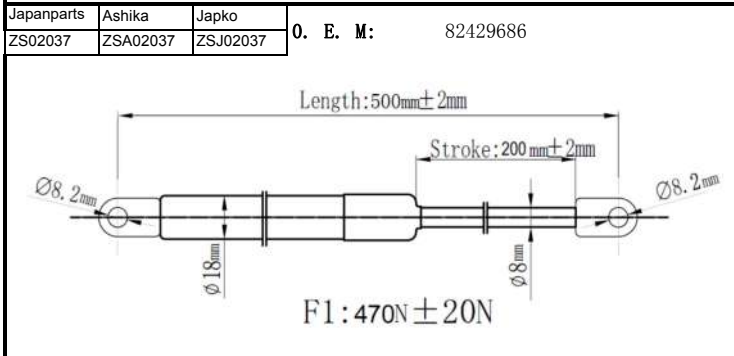
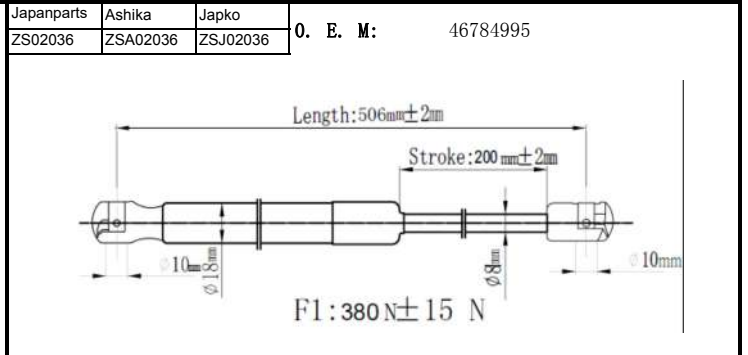
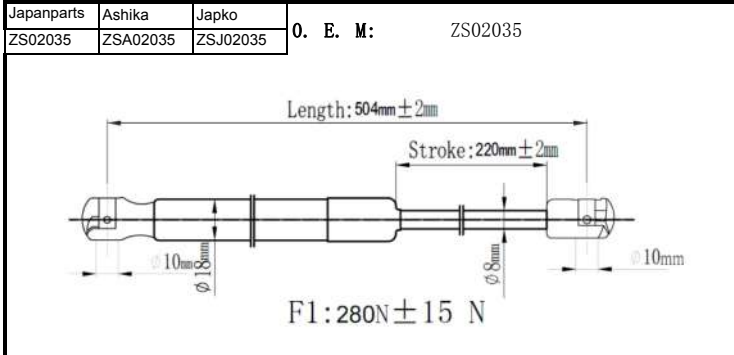
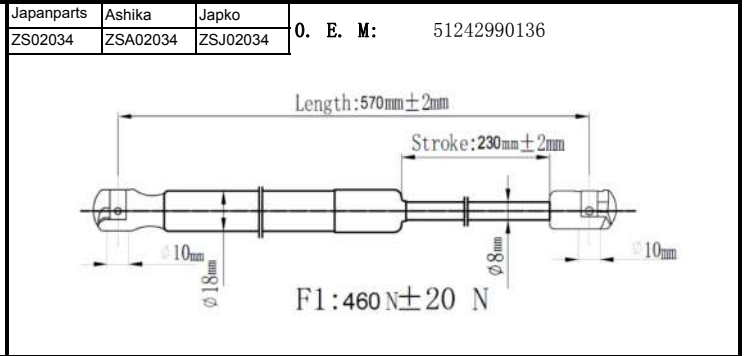
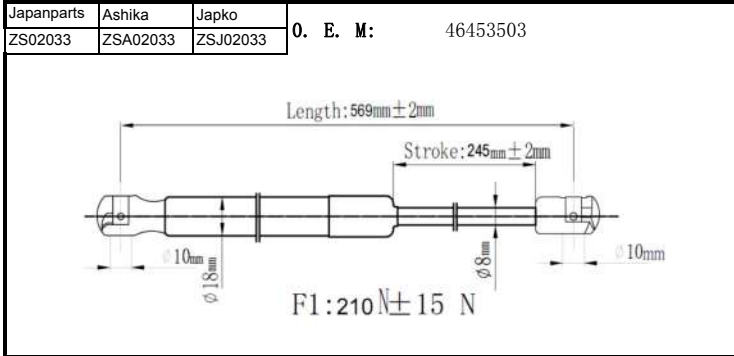
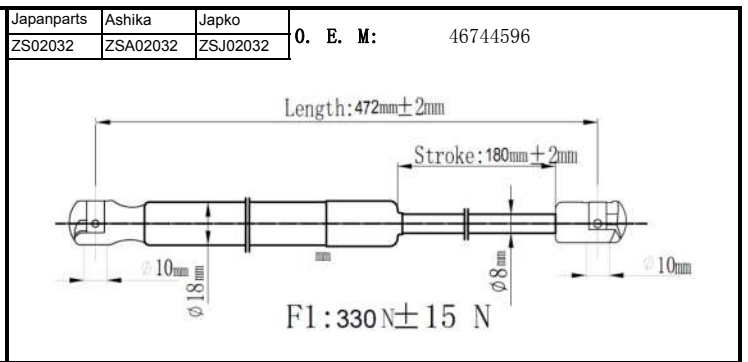
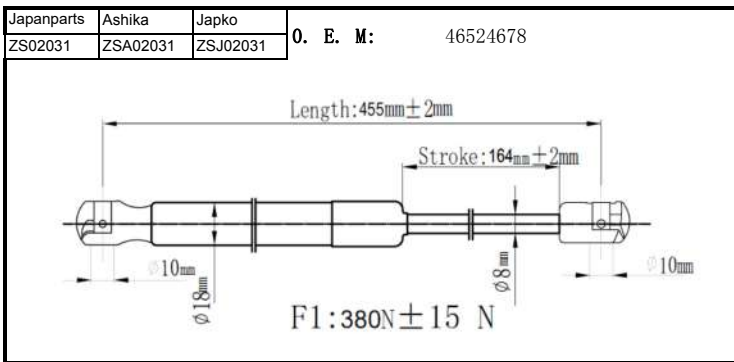

| | | |
|------------|----------|----------|
| Japanparts | Ashika | Japko |
| ZS02043 | ZSA02043 | ZSJ02043 |

O. E. M: 7774707

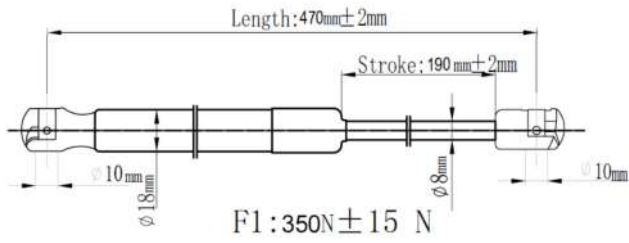

| | | |
|------------|----------|----------|
| Japanparts | Ashika | Japko |
| ZS02044 | ZSA02044 | ZSJ02044 |

O. E. M: 3966192

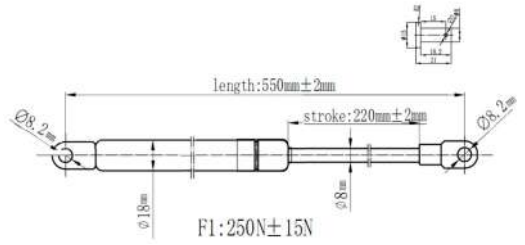

| | | |
|------------|----------|----------|
| Japanparts | Ashika | Japko |
| ZS02045 | ZSA02045 | ZSJ02045 |

O. E. M:

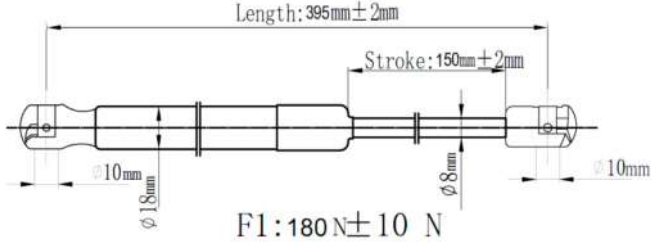

| | | |
|------------|----------|----------|
| Japanparts | Ashika | Japko |
| ZS02046 | ZSA02046 | ZSJ02046 |

O. E. M: 46400256

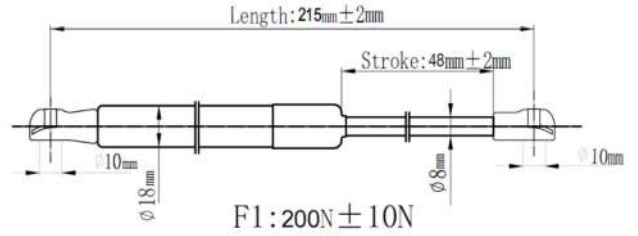

| | | |
|------------|----------|----------|
| Japanparts | Ashika | Japko |
| ZS02047 | ZSA02047 | ZSJ02047 |

O. E. M: 51716995

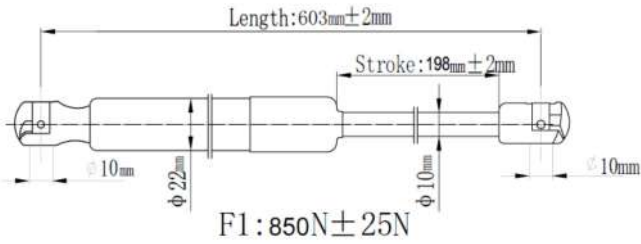

| | | |
|------------|----------|----------|
| Japanparts | Ashika | Japko |
| ZS02048 | ZSA02048 | ZSJ02048 |

O. E. M: 46762434

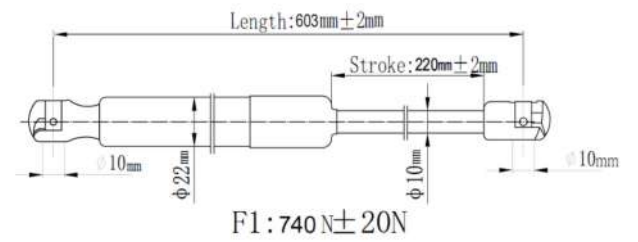

| | | |
|------------|----------|----------|
| Japanparts | Ashika | Japko |
| ZS02049 | ZSA02049 | ZSJ02049 |

O. E. M: 46773097

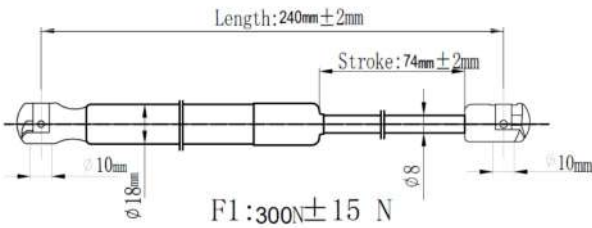

| | | |
|------------|----------|----------|
| Japanparts | Ashika | Japko |
| ZS02050 | ZSA02050 | ZSJ02050 |

O. E. M: 487670

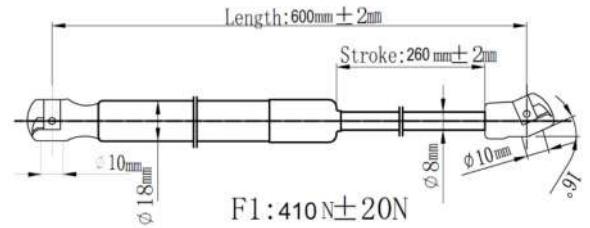

| | | |
|------------|----------|----------|
| Japanparts | Ashika | Japko |
| ZS02051 | ZSA02051 | ZSJ02051 |

O. E. M: 4297742

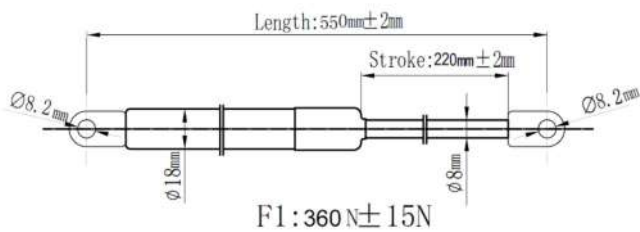

| | | |
|------------|----------|----------|
| Japanparts | Ashika | Japko |
| ZS02052 | ZSA02052 | ZSJ02052 |

O. E. M: 7587706

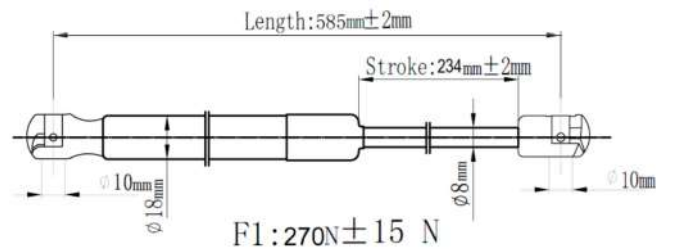

| | | |
|------------|----------|----------|
| Japanparts | Ashika | Japko |
| ZS02053 | ZSA02053 | ZSJ02053 |

O. E. M: 4424045

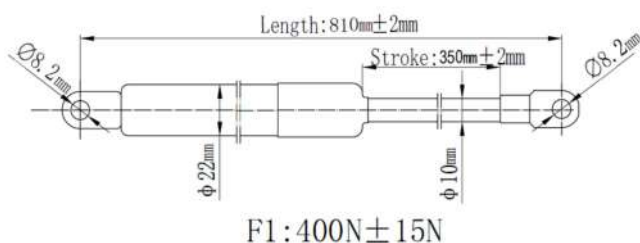

| | | |
|------------|----------|----------|
| Japanparts | Ashika | Japko |
| ZS02054 | ZSA02054 | ZSJ02054 |

O. E. M: 7606304

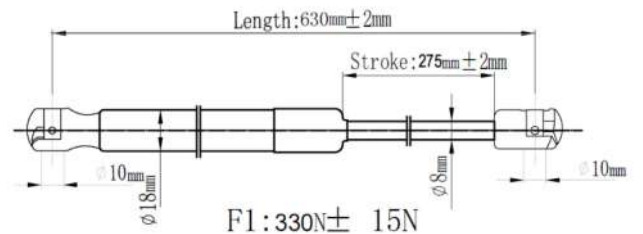

| | | |
|------------|----------|----------|
| Japanparts | Ashika | Japko |
| ZS02055 | ZSA02055 | ZSJ02055 |

O. E. M.: 46304279

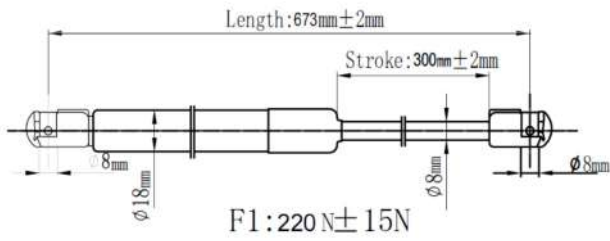

| | | |
|------------|----------|----------|
| Japanparts | Ashika | Japko |
| ZS02056 | ZSA02056 | ZSJ02056 |

O. E. M.: 1640341

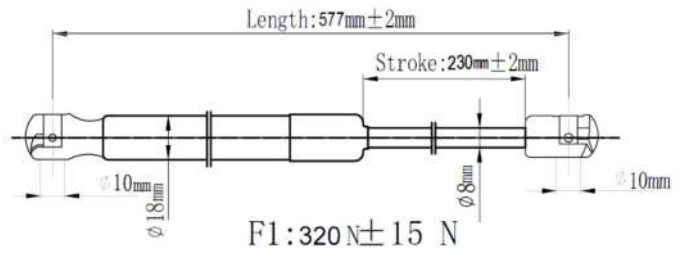

| | | |
|------------|----------|----------|
| Japanparts | Ashika | Japko |
| ZS02057 | ZSA02057 | ZSJ02057 |

O. E. M.: 46720558

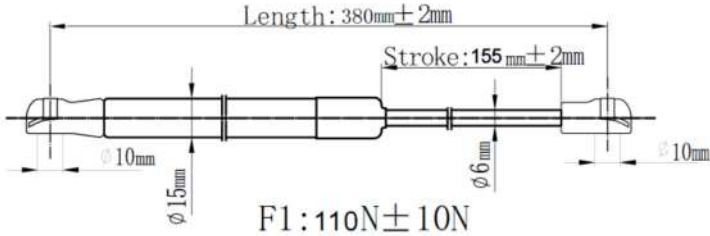

| | | |
|------------|----------|----------|
| Japanparts | Ashika | Japko |
| ZS02058 | ZSA02058 | ZSJ02058 |

O. E. M.: 46730681

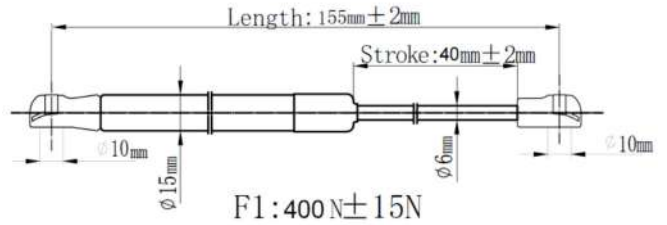

| | | |
|------------|----------|----------|
| Japanparts | Ashika | Japko |
| ZS02059 | ZSA02059 | ZSJ02059 |

O. E. M.: 47300075

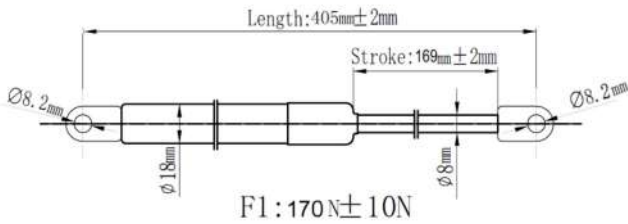

| | | |
|------------|----------|----------|
| Japanparts | Ashika | Japko |
| ZS02060 | ZSA02060 | ZSJ02060 |

O. E. M.: 51751743

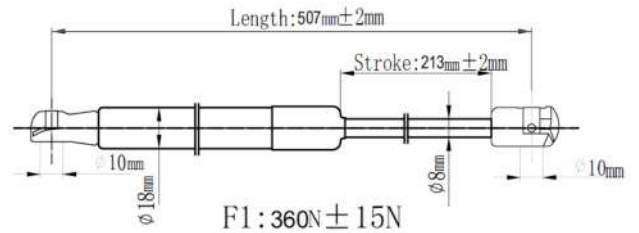

| | | |
|------------|----------|----------|
| Japanparts | Ashika | Japko |
| ZS02061 | ZSA02061 | ZSJ02061 |

O. E. M.: 51927230

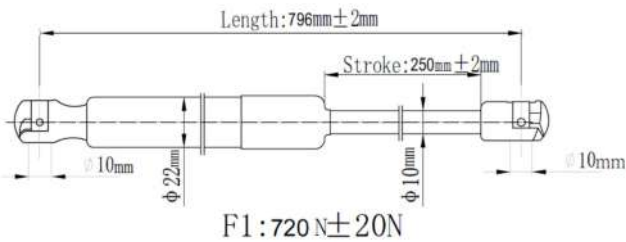

| | | |
|------------|----------|----------|
| Japanparts | Ashika | Japko |
| ZS02062 | ZSA02062 | ZSJ02062 |

O. E. M.: 46734809

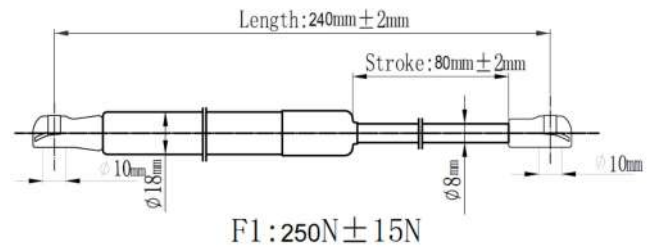

| | | |
|------------|----------|----------|
| Japanparts | Ashika | Japko |
| ZS02063 | ZSA02063 | ZSJ02063 |

O. E. M.: 5981660

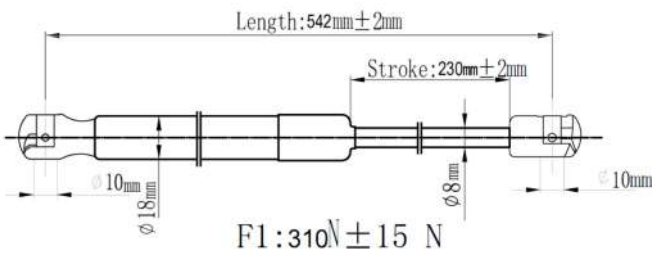

| | | |
|------------|----------|----------|
| Japanparts | Ashika | Japko |
| ZS02064 | ZSA02064 | ZSJ02064 |

O. E. M.: 51883050

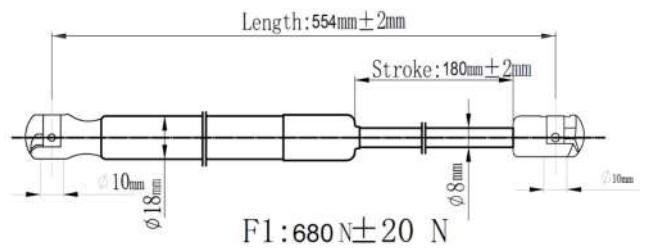

| | | |
|------------|----------|----------|
| Japanparts | Ashika | Japko |
| ZS02065 | ZSA02065 | ZSJ02065 |

O. E. M.: 51785412

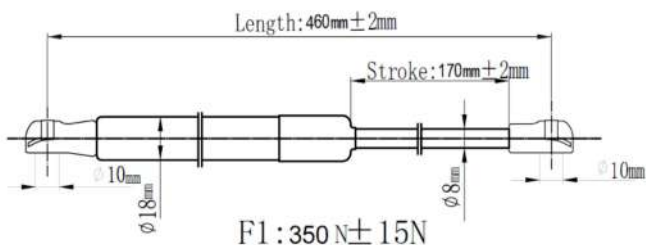

| | | |
|------------|----------|----------|
| Japanparts | Ashika | Japko |
| ZS02066 | ZSA02066 | ZSJ02066 |

O. E. M.:

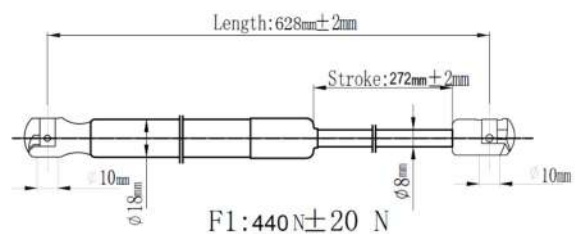

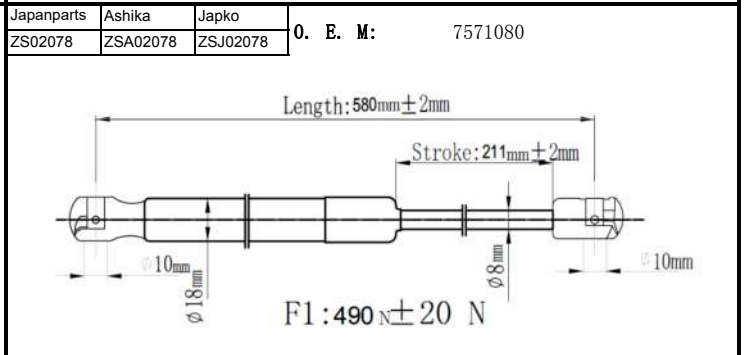
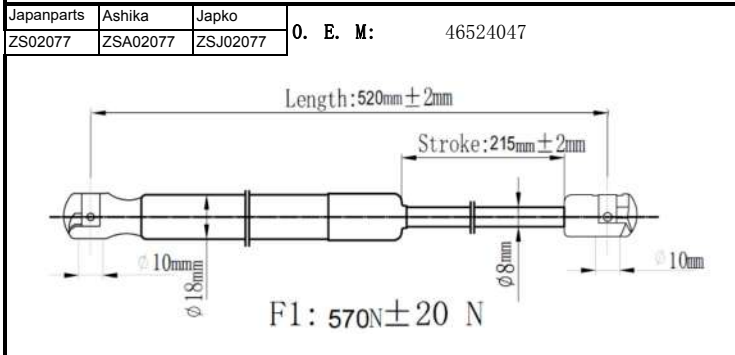
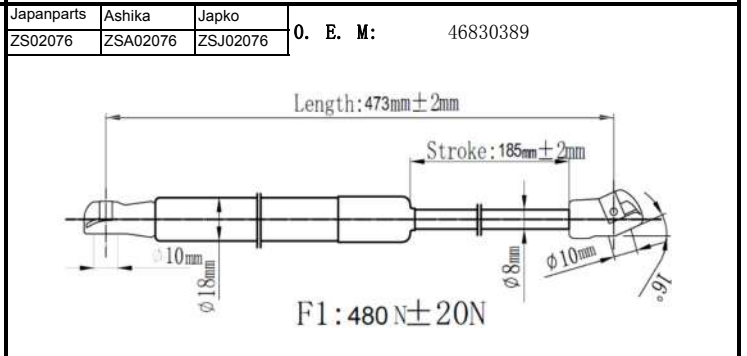
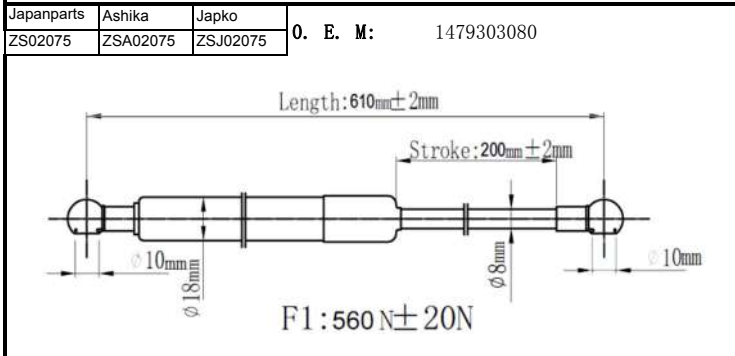
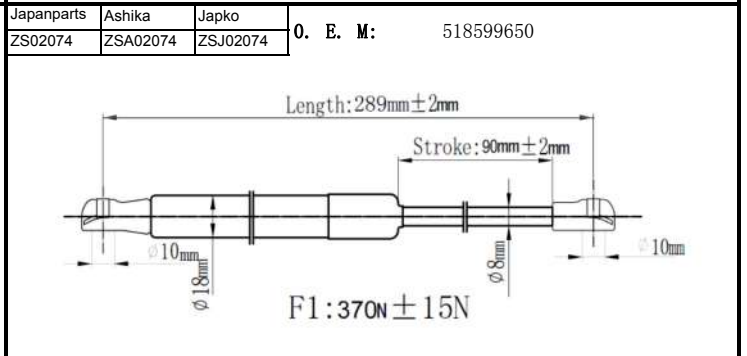
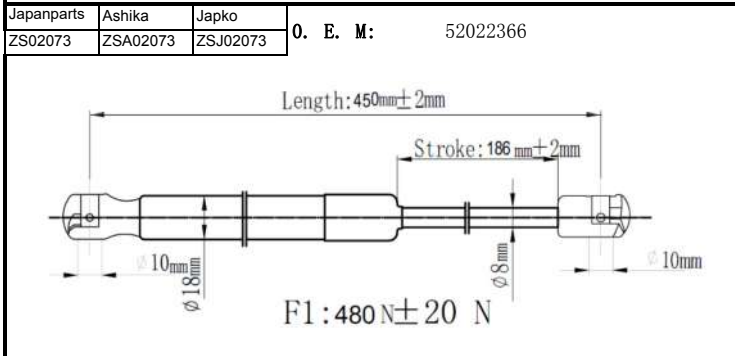
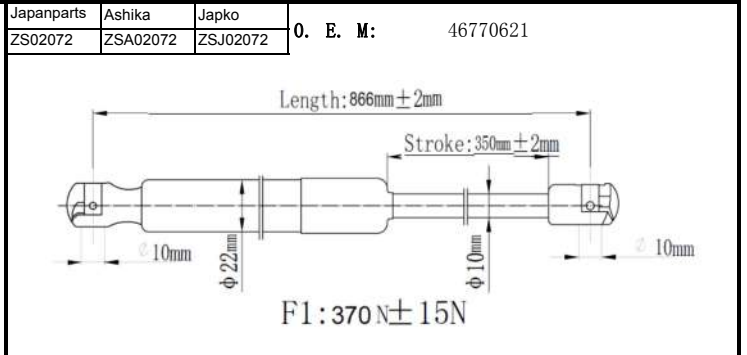
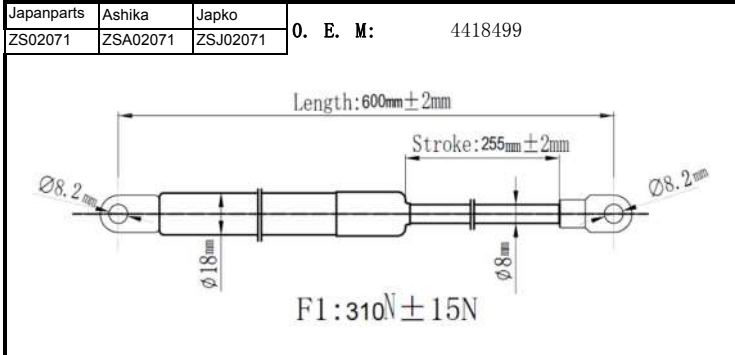
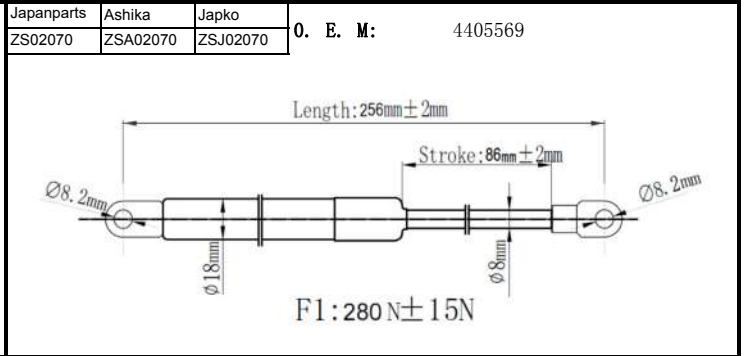
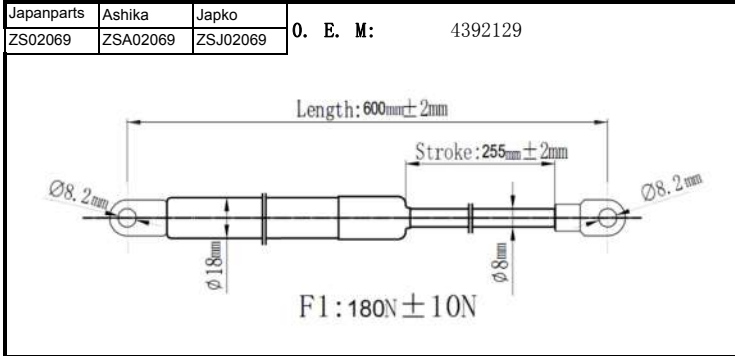
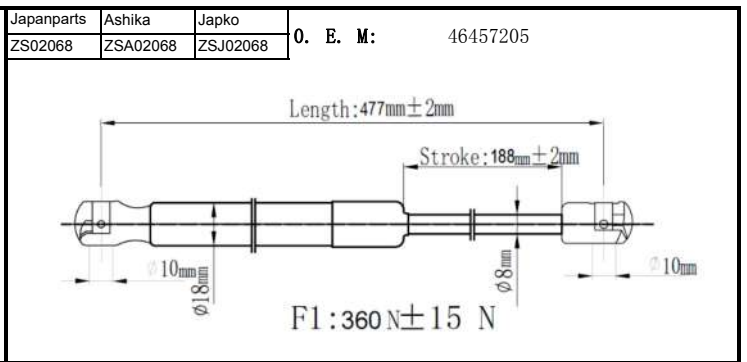
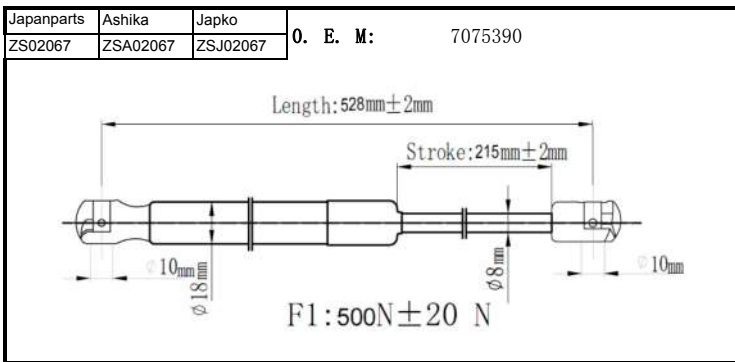

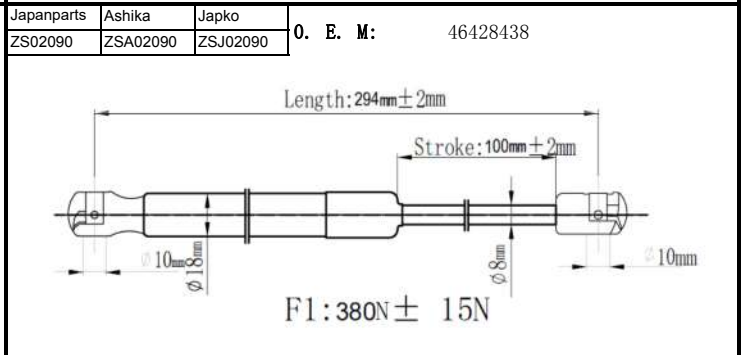
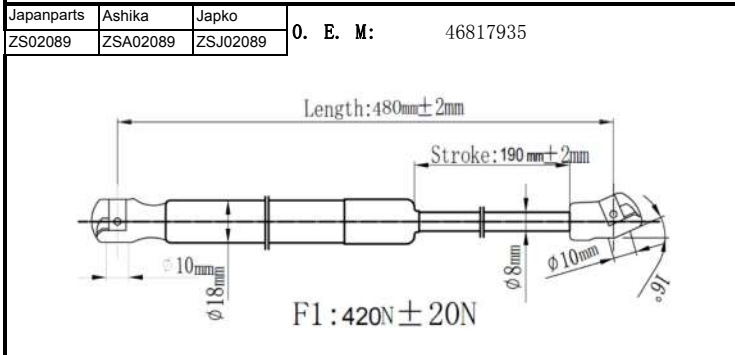
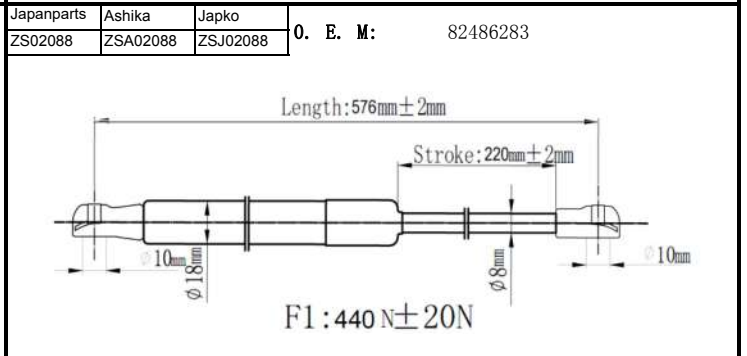
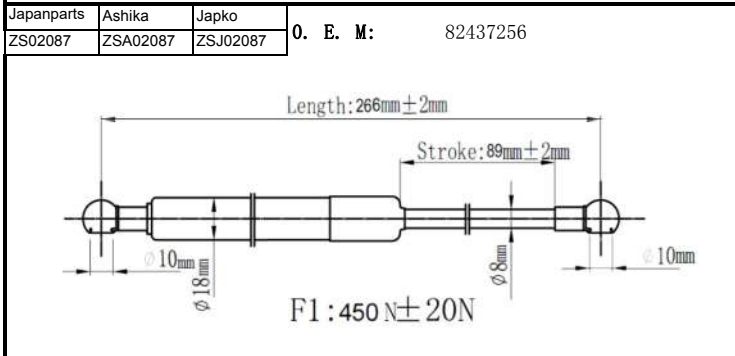
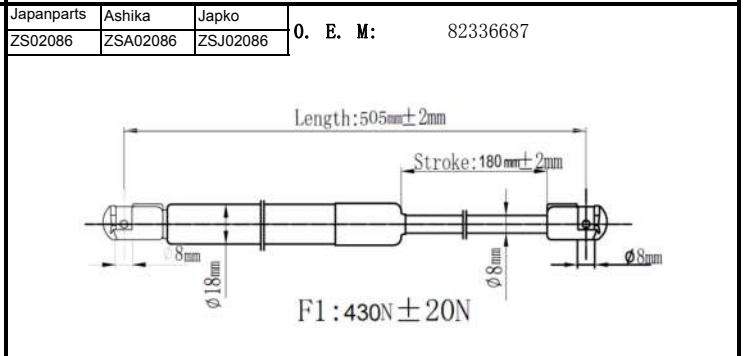
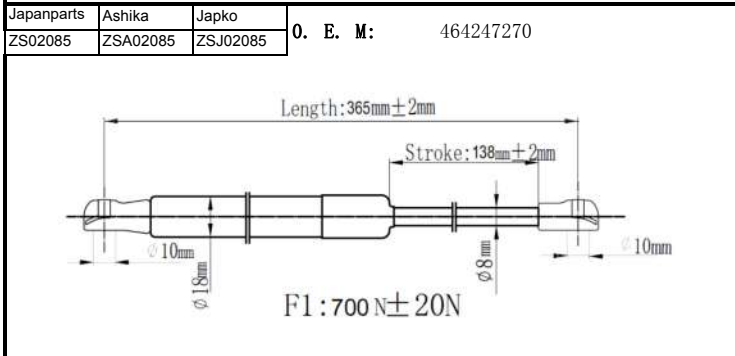
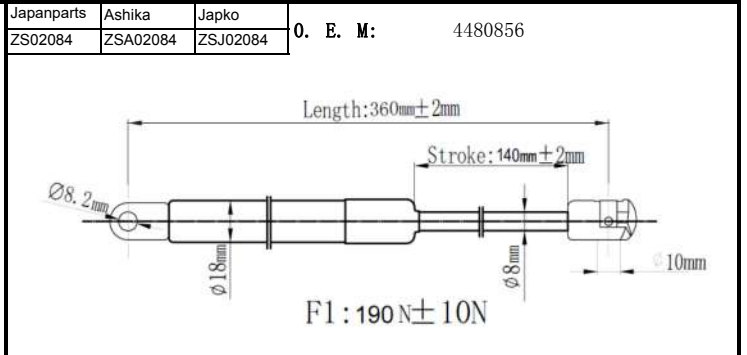
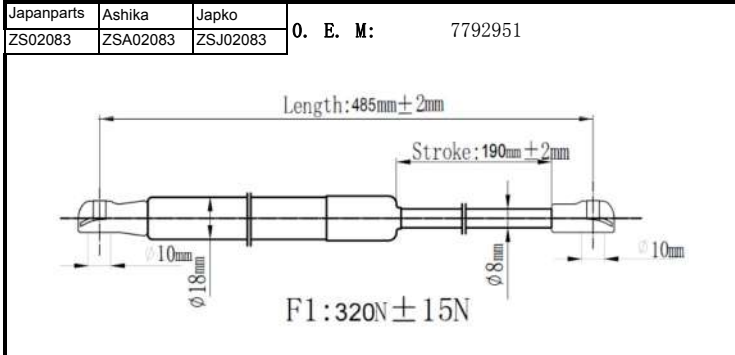
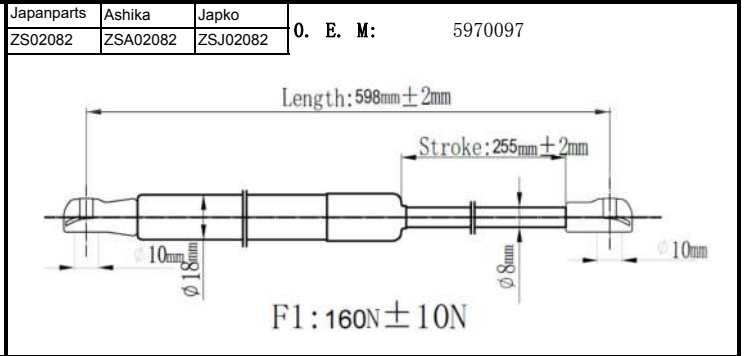
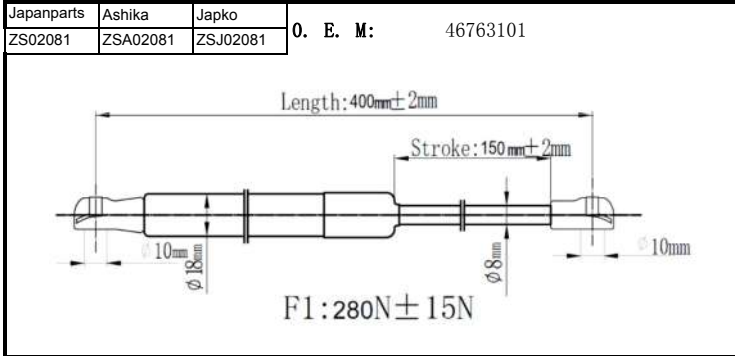
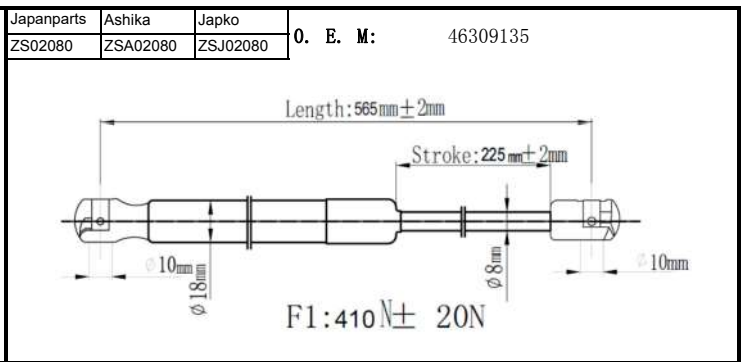
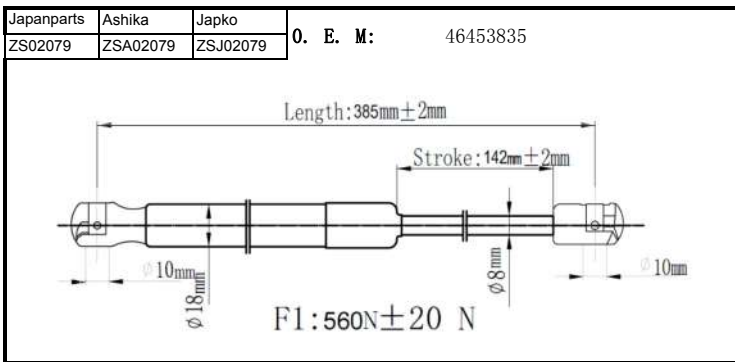

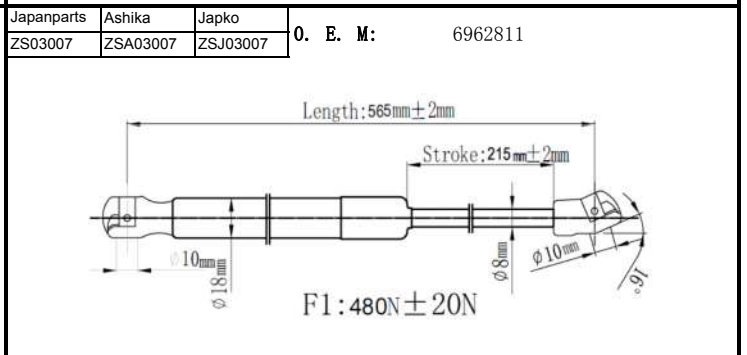
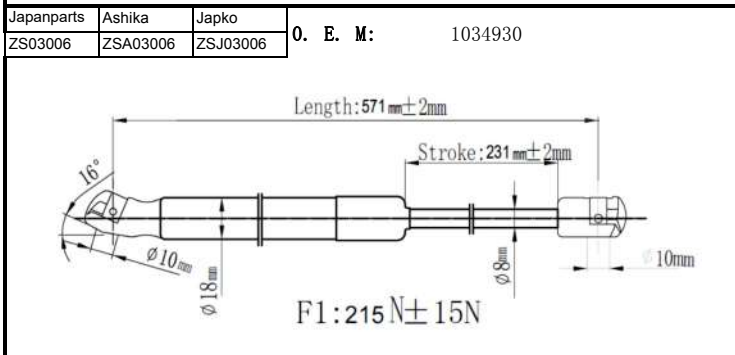
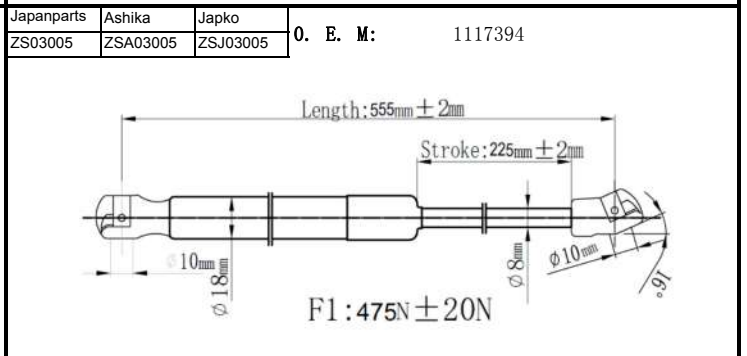
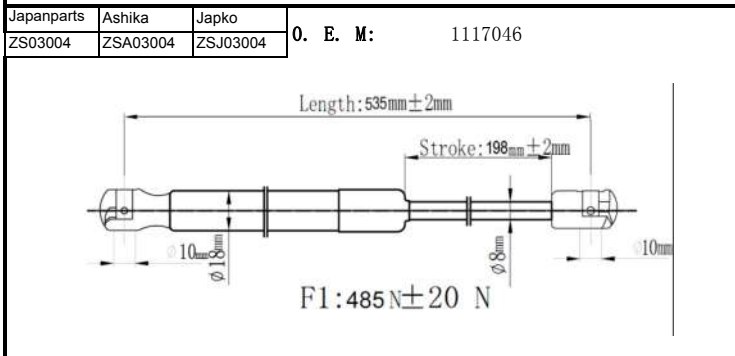
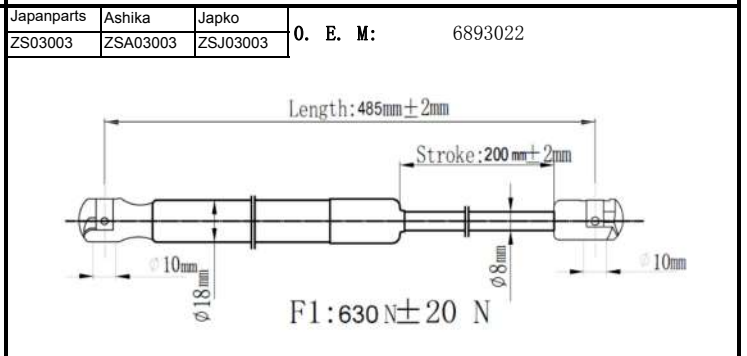
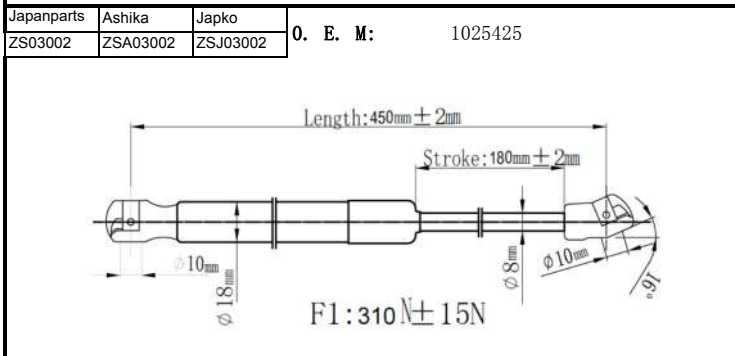
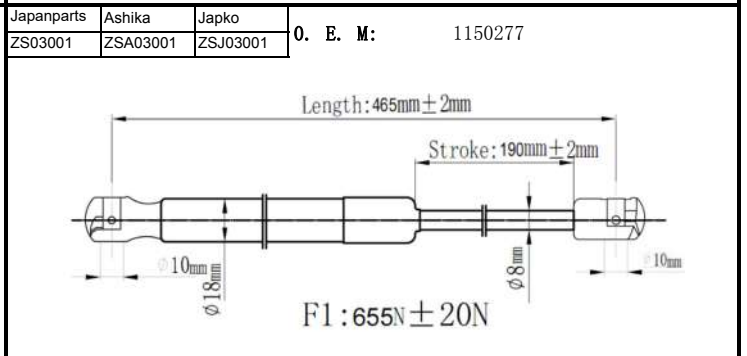
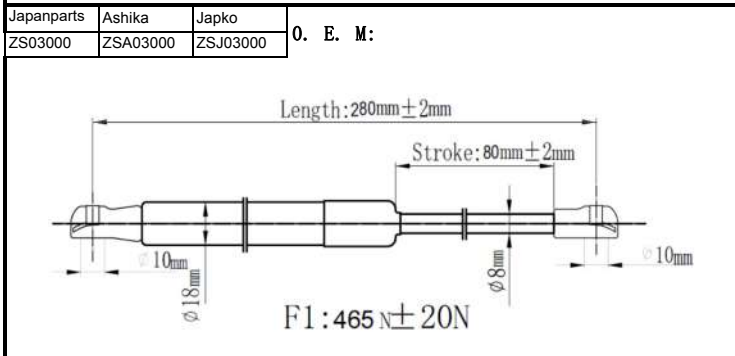
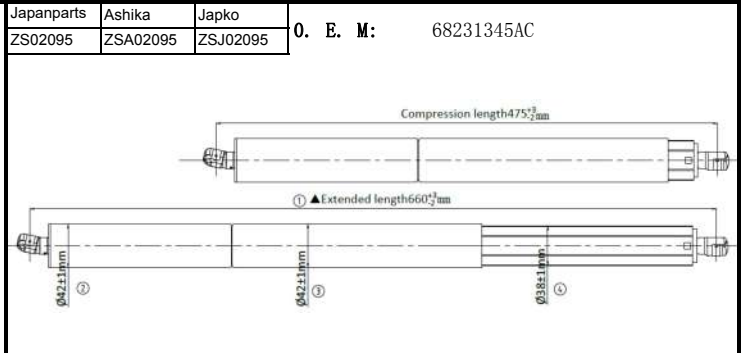
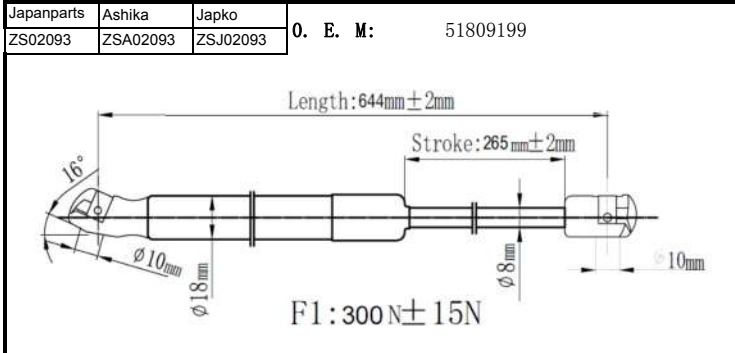
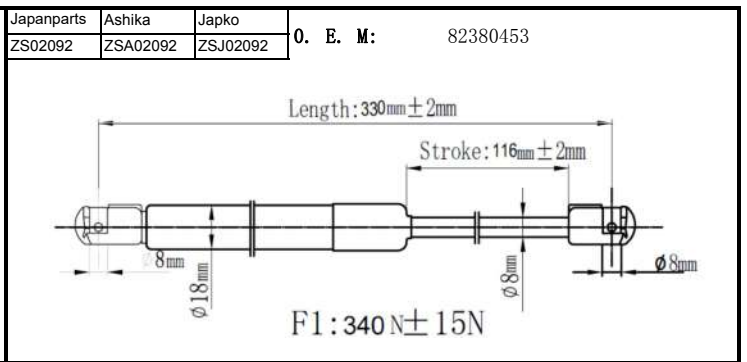
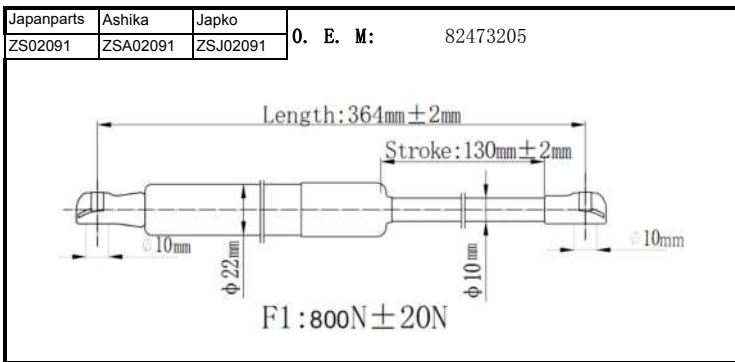

| | | |
|------------|----------|----------|
| Japanparts | Ashika | Japko |
| ZS03008 | ZSA03008 | ZSJ03008 |

O. E. M.: 1117690

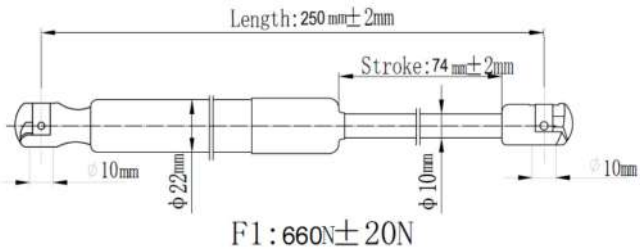

| | | |
|------------|----------|----------|
| Japanparts | Ashika | Japko |
| ZS03009 | ZSA03009 | ZSJ03009 |

O. E. M.: 2T14-V406A10-AB

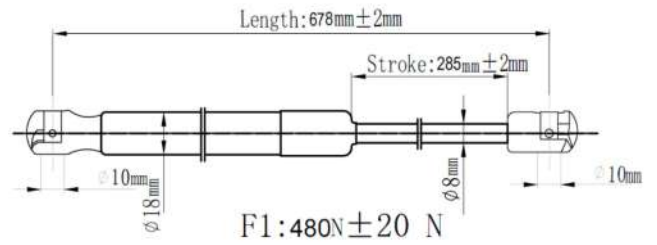

| | | |
|------------|----------|----------|
| Japanparts | Ashika | Japko |
| ZS03010 | ZSA03010 | ZSJ03010 |

O. E. M.: 1117246

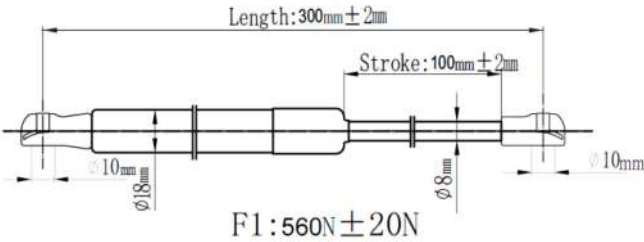

| | | |
|------------|----------|----------|
| Japanparts | Ashika | Japko |
| ZS03011 | ZSA03011 | ZSJ03011 |

O. E. M.: 1C15V406A10AD

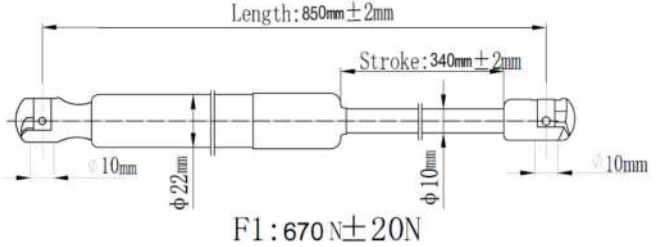

| | | |
|------------|----------|----------|
| Japanparts | Ashika | Japko |
| ZS03012 | ZSA03012 | ZSJ03012 |

O. E. M.: 1C15V406A10CC

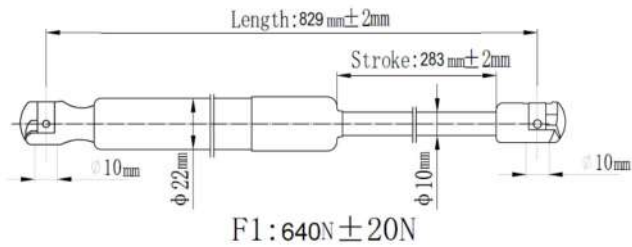

| | | |
|------------|----------|----------|
| Japanparts | Ashika | Japko |
| ZS03013 | ZSA03013 | ZSJ03013 |

O. E. M.: 1229461

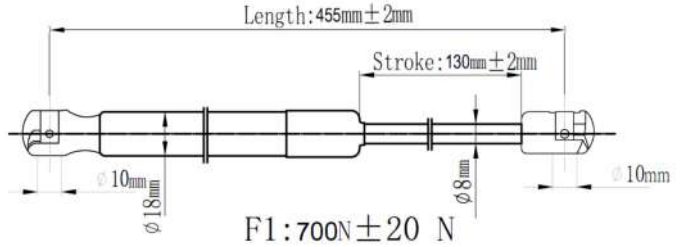

| | | |
|------------|----------|----------|
| Japanparts | Ashika | Japko |
| ZS03014 | ZSA03014 | ZSJ03014 |

O. E. M.: 6844981

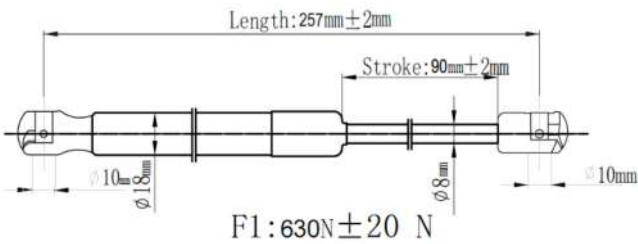

| | | |
|------------|----------|----------|
| Japanparts | Ashika | Japko |
| ZS03015 | ZSA03015 | ZSJ03015 |

O. E. M.: 1349309

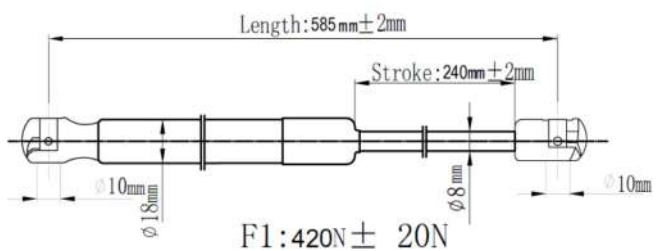

| | | |
|------------|----------|----------|
| Japanparts | Ashika | Japko |
| ZS03016 | ZSA03016 | ZSJ03016 |

O. E. M.: 1537538

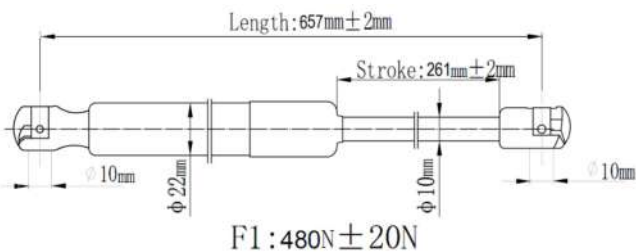

| | | |
|------------|----------|----------|
| Japanparts | Ashika | Japko |
| ZS03017 | ZSA03017 | ZSJ03017 |

O. E. M.: 1542413

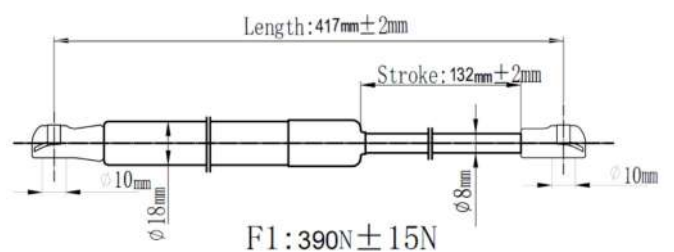

| | | |
|------------|----------|----------|
| Japanparts | Ashika | Japko |
| ZS03018 | ZSA03018 | ZSJ03018 |

O. E. M.: 4095833

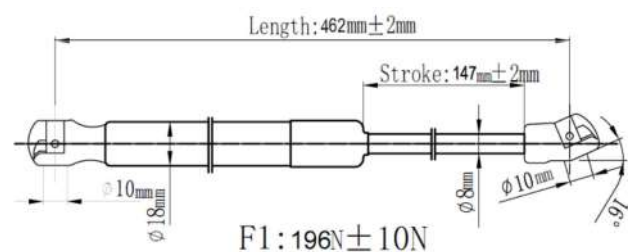

| | | |
|------------|----------|----------|
| Japanparts | Ashika | Japko |
| ZS03019 | ZSA03019 | ZSJ03019 |

O. E. M.: 1120611

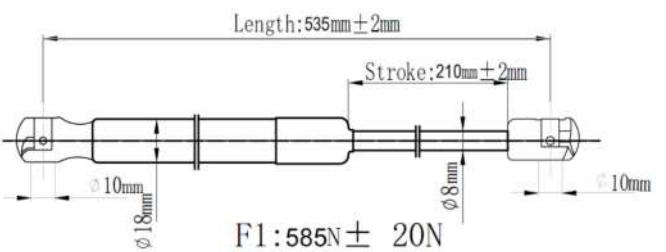

| | | |
|------------|----------|----------|
| Japanparts | Ashika | Japko |
| ZS03020 | ZSA03020 | ZSJ03020 |

O. E. M.: 1637863

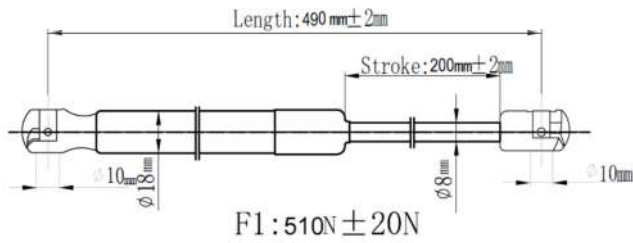

| | | |
|------------|----------|----------|
| Japanparts | Ashika | Japko |
| ZS03021 | ZSA03021 | ZSJ03021 |

O. E. M.: 6142657

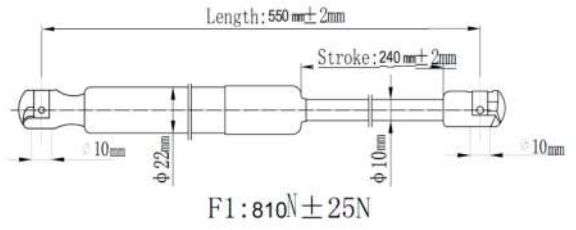

| | | |
|------------|----------|----------|
| Japanparts | Ashika | Japko |
| ZS03022 | ZSA03022 | ZSJ03022 |

O. E. M.: 1718369

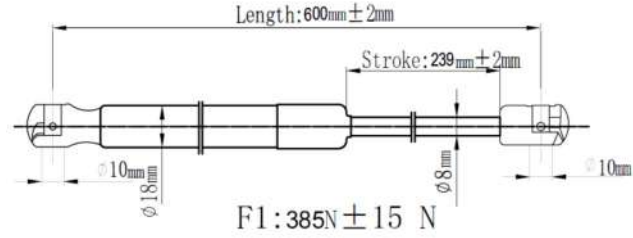

| | | |
|------------|----------|----------|
| Japanparts | Ashika | Japko |
| ZS03023 | ZSA03023 | ZSJ03023 |

O. E. M.: 1484158

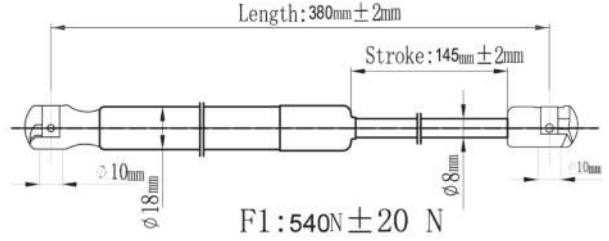

| | | |
|------------|----------|----------|
| Japanparts | Ashika | Japko |
| ZS03024 | ZSA03024 | ZSJ03024 |

O. E. M.: 1477988

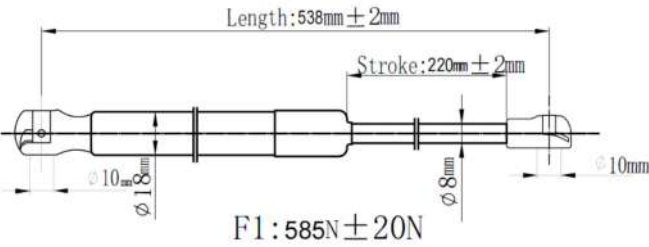

| | | |
|------------|----------|----------|
| Japanparts | Ashika | Japko |
| ZS03025 | ZSA03025 | ZSJ03025 |

O. E. M.: 1141159

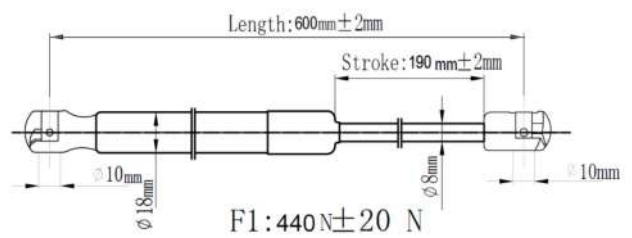

| | | |
|------------|----------|----------|
| Japanparts | Ashika | Japko |
| ZS03026 | ZSA03026 | ZSJ03026 |

O. E. M.: 2L1Z16C826AA

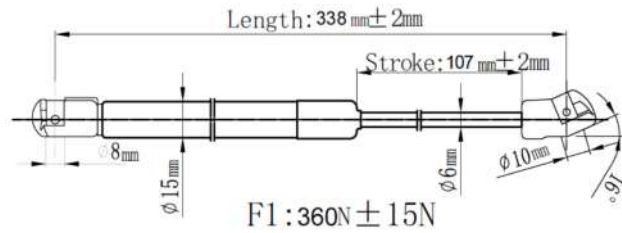

| | | |
|------------|----------|----------|
| Japanparts | Ashika | Japko |
| ZS03027 | ZSA03027 | ZSJ03027 |

O. E. M.: 6L2Z16C826AA

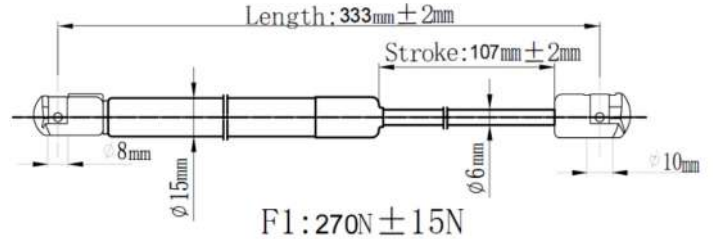

| | | |
|------------|----------|----------|
| Japanparts | Ashika | Japko |
| ZS03028 | ZSA03028 | ZSJ03028 |

O. E. M.: 1062976

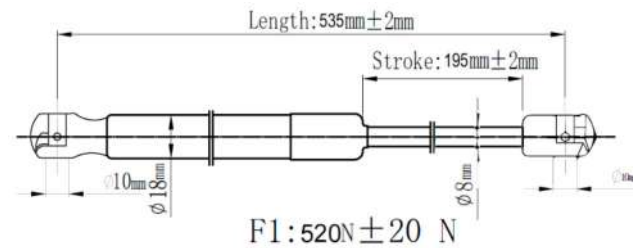

| | | |
|------------|----------|----------|
| Japanparts | Ashika | Japko |
| ZS03029 | ZSA03029 | ZSJ03029 |

O. E. M.: F4TZ78406A10A

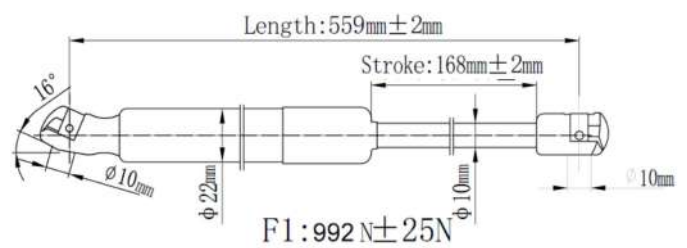

| | | |
|------------|----------|----------|
| Japanparts | Ashika | Japko |
| ZS03030 | ZSA03030 | ZSJ03030 |

O. E. M.: F67Z16C826AA

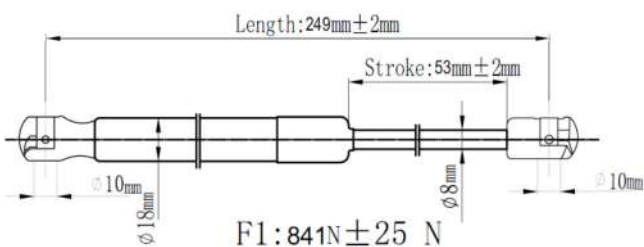

| | | |
|------------|----------|----------|
| Japanparts | Ashika | Japko |
| ZS03031 | ZSA03031 | ZSJ03031 |

O. E. M.: 1460236

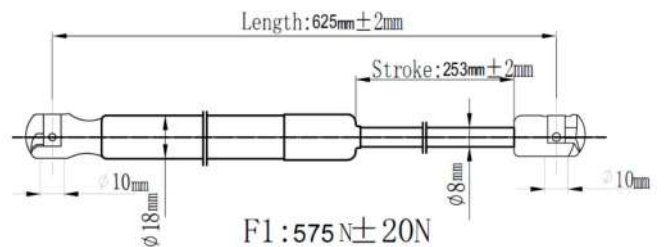

| | | |
|------------|----------|----------|
| Japanparts | Ashika | Japko |
| ZS03032 | ZSA03032 | ZSJ03032 |

O. E. M.: 1492389

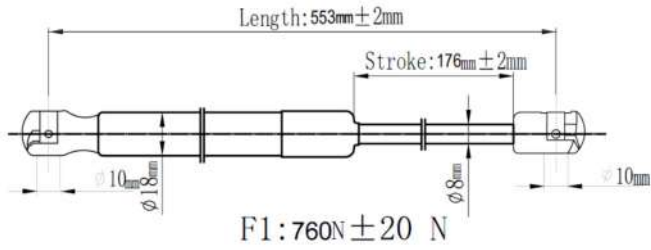

| | | |
|------------|----------|----------|
| Japanparts | Ashika | Japko |
| ZS03033 | ZSA03033 | ZSJ03033 |

O. E. M.: 1212586

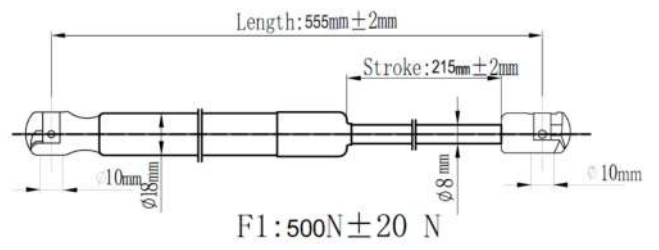

| | | |
|------------|----------|----------|
| Japanparts | Ashika | Japko |
| ZS03034 | ZSA03034 | ZSJ03034 |

O. E. M.: 6900216

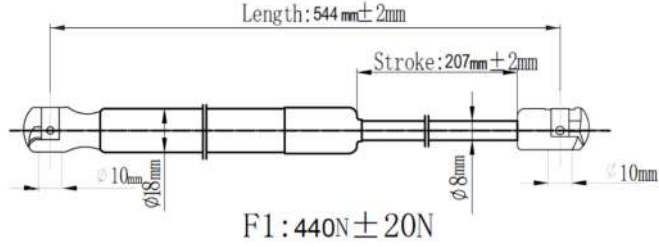

| | | |
|------------|----------|----------|
| Japanparts | Ashika | Japko |
| ZS03035 | ZSA03035 | ZSJ03035 |

O. E. M.: 6164002

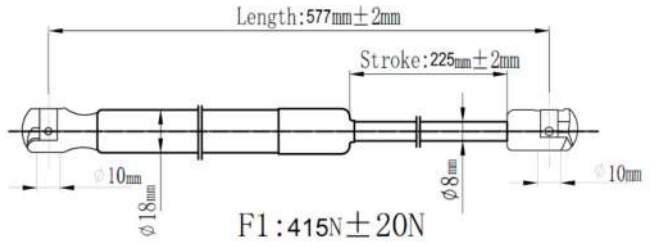

| | | |
|------------|----------|----------|
| Japanparts | Ashika | Japko |
| ZS03036 | ZSA03036 | ZSJ03036 |

O. E. M.: 1020155

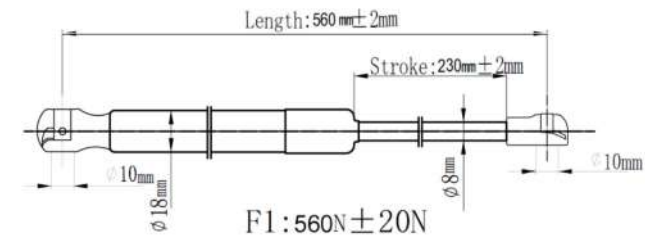

| | | |
|------------|----------|----------|
| Japanparts | Ashika | Japko |
| ZS03037 | ZSA03037 | ZSJ03037 |

O. E. M.: 1736612

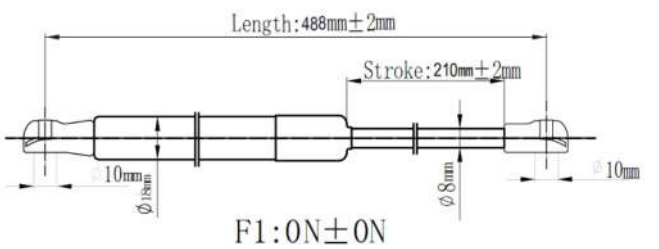

| | | |
|------------|----------|----------|
| Japanparts | Ashika | Japko |
| ZS03038 | ZSA03038 | ZSJ03038 |

O. E. M.: 1686835

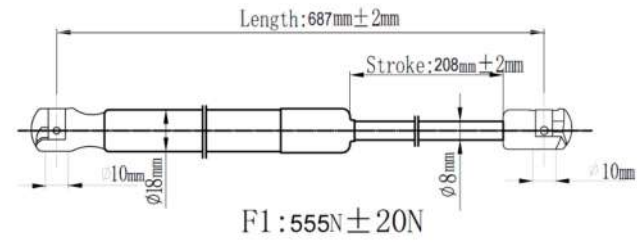

| | | |
|------------|----------|----------|
| Japanparts | Ashika | Japko |
| ZS03039 | ZSA03039 | ZSJ03039 |

O. E. M.: 6E5Z54406A10A

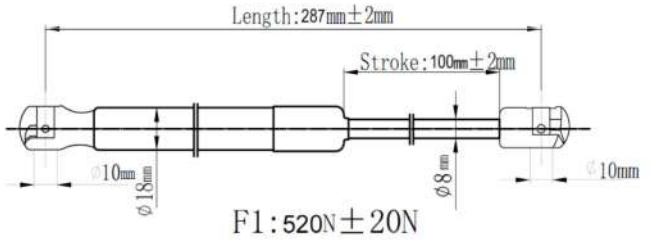

| | | |
|------------|----------|----------|
| Japanparts | Ashika | Japko |
| ZS03040 | ZSA03040 | ZSJ03040 |

O. E. M.: 1L2Z16C826AA

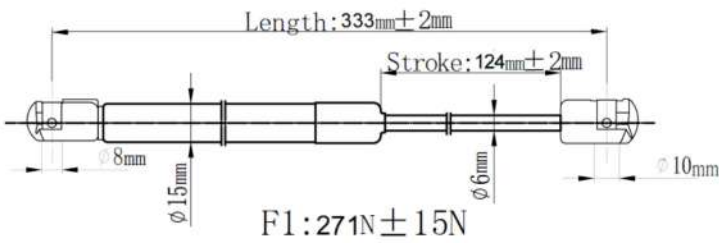

| | | |
|------------|----------|----------|
| Japanparts | Ashika | Japko |
| ZS03041 | ZSA03041 | ZSJ03041 |

O. E. M.: 1075742

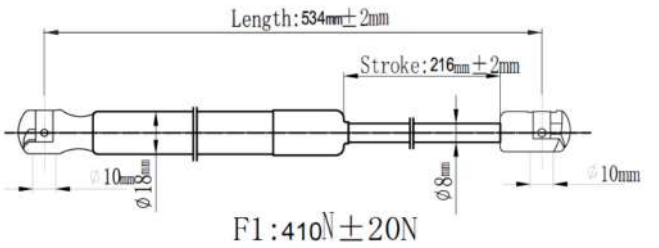

| | | |
|------------|----------|----------|
| Japanparts | Ashika | Japko |
| ZS03042 | ZSA03042 | ZSJ03042 |

O. E. M.: F81Z16C826AB

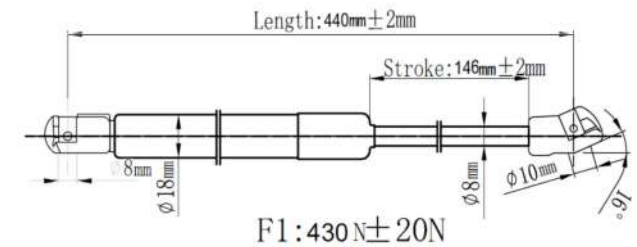

| | | |
|------------|----------|----------|
| Japanparts | Ashika | Japko |
| ZS03043 | ZSA03043 | ZSJ03043 |

O. E. M.: 1336159

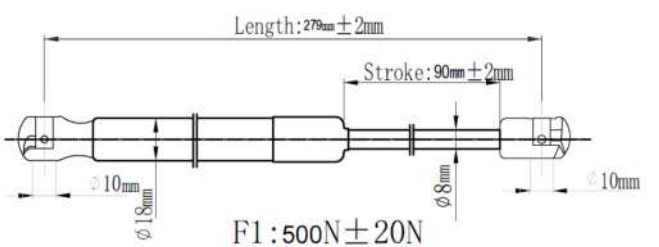

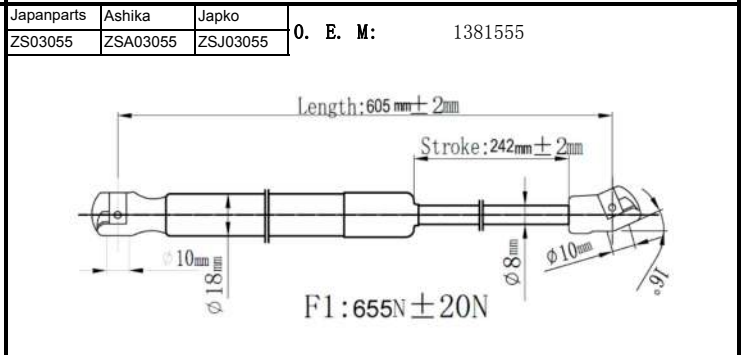
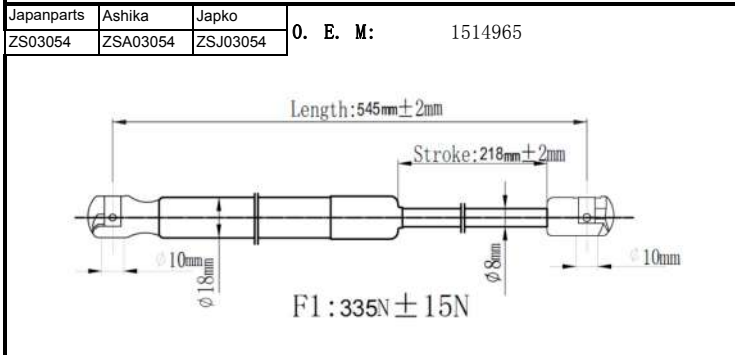
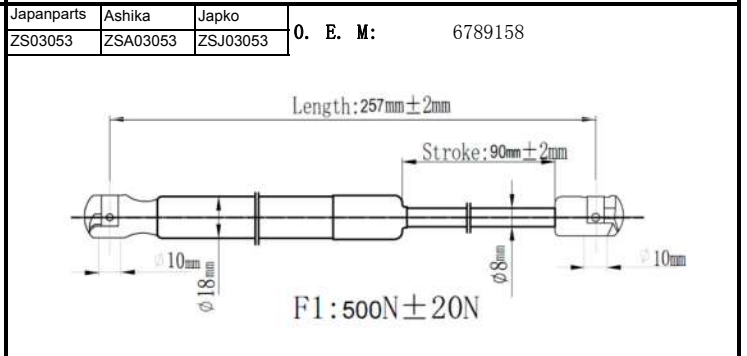
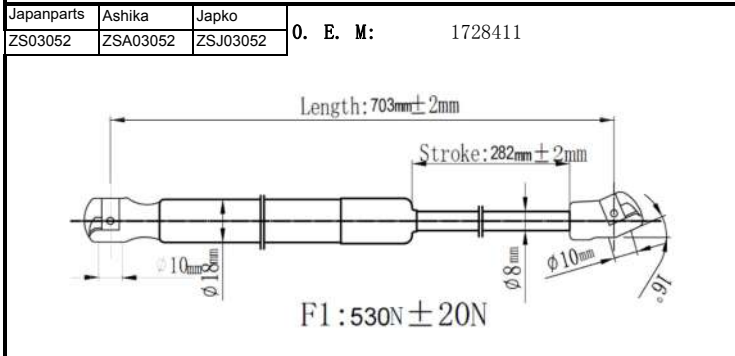
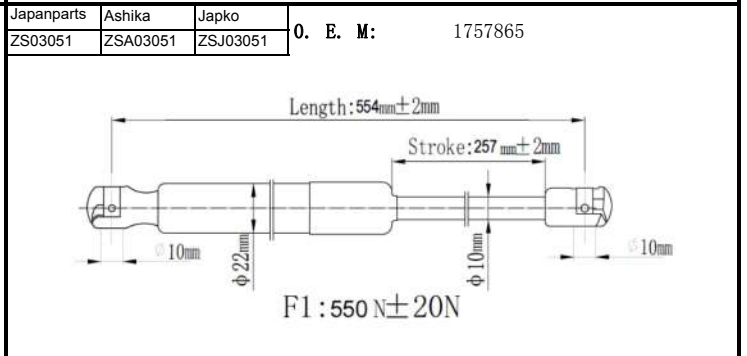
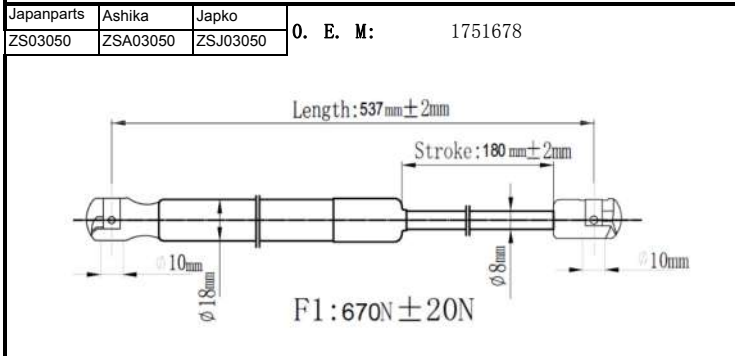
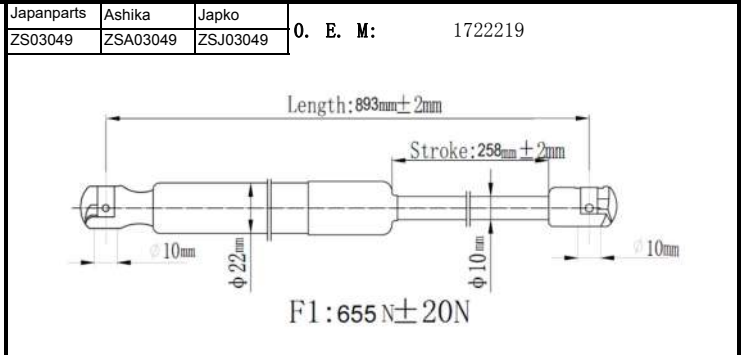
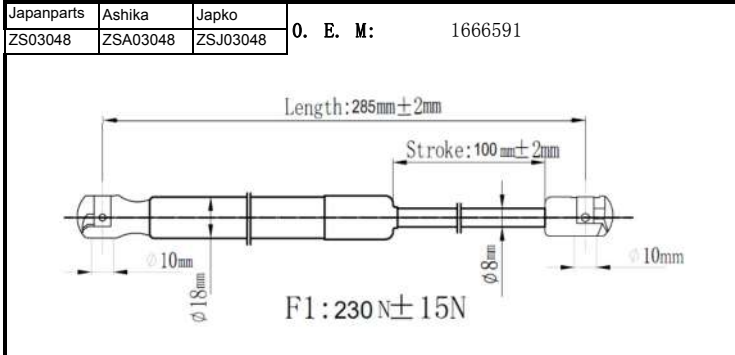
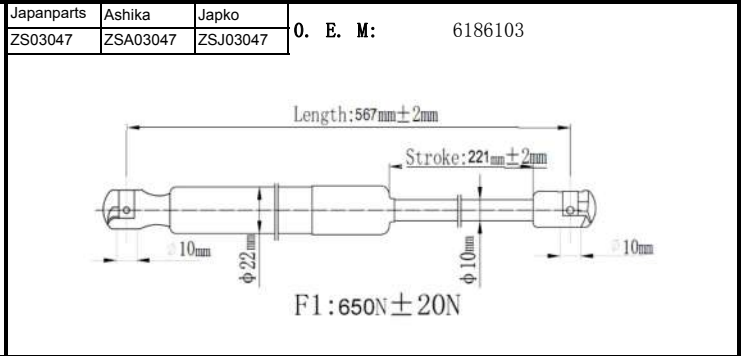
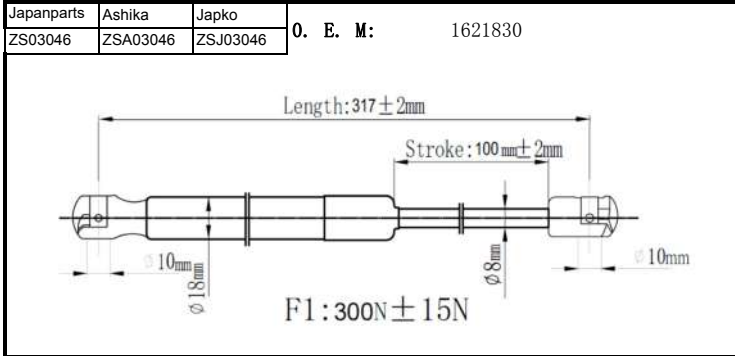
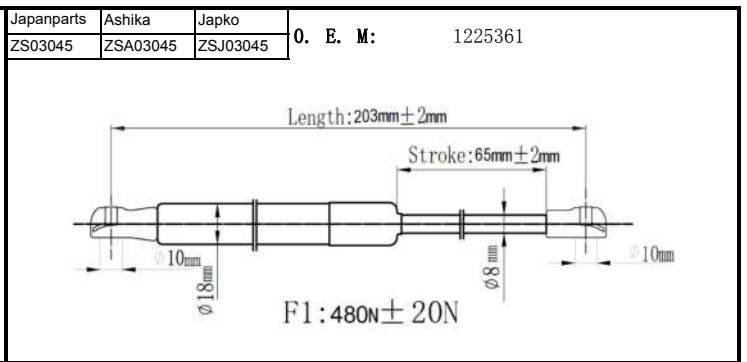
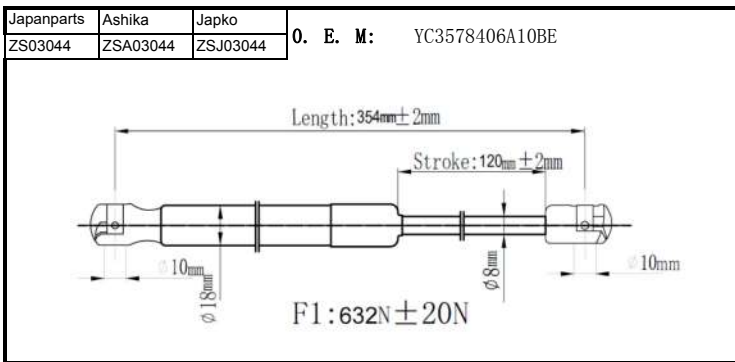

| | | |
|------------|----------|----------|
| Japanparts | Ashika | Japko |
| ZS03056 | ZSA03056 | ZSJ03056 |

O. E. M.: 1405189

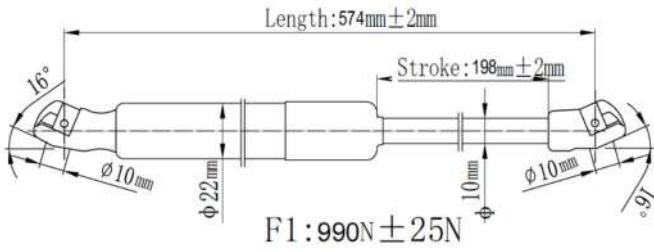

| | | |
|------------|----------|----------|
| Japanparts | Ashika | Japko |
| ZS03057 | ZSA03057 | ZSJ03057 |

O. E. M.: 6148421

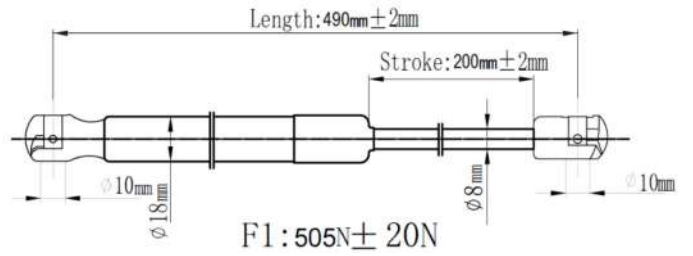

| | | |
|------------|----------|----------|
| Japanparts | Ashika | Japko |
| ZS03058 | ZSA03058 | ZSJ03058 |

O. E. M.: 6186100

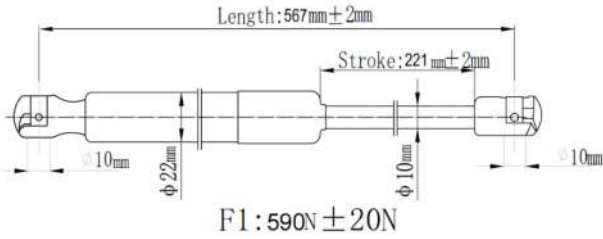

| | | |
|------------|----------|----------|
| Japanparts | Ashika | Japko |
| ZS03059 | ZSA03059 | ZSJ03059 |

O. E. M.: 6965594

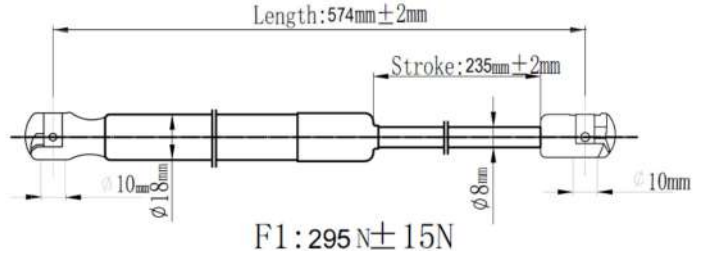

| | | |
|------------|----------|----------|
| Japanparts | Ashika | Japko |
| ZS03060 | ZSA03060 | ZSJ03060 |

O. E. M.: 6150465

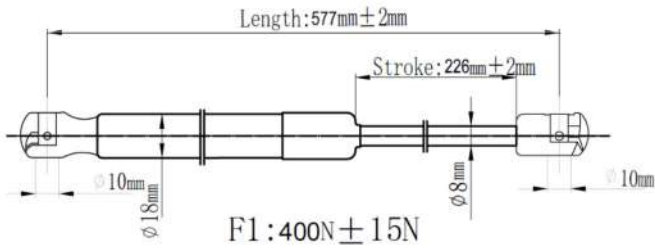

| | | |
|------------|----------|----------|
| Japanparts | Ashika | Japko |
| ZS03061 | ZSA03061 | ZSJ03061 |

O. E. M.: 1632756

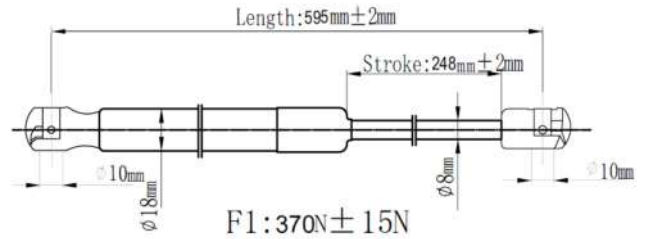

| | | |
|------------|----------|----------|
| Japanparts | Ashika | Japko |
| ZS03062 | ZSA03062 | ZSJ03062 |

O. E. M.: 1661167

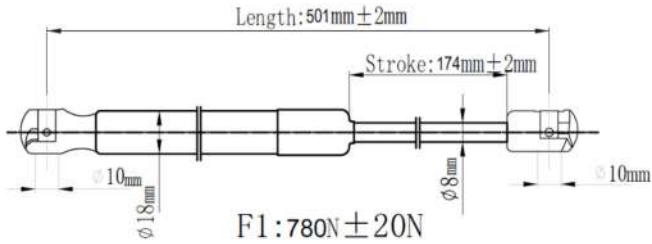

| | | |
|------------|----------|----------|
| Japanparts | Ashika | Japko |
| ZS03063 | ZSA03063 | ZSJ03063 |

O. E. M.: 7245797

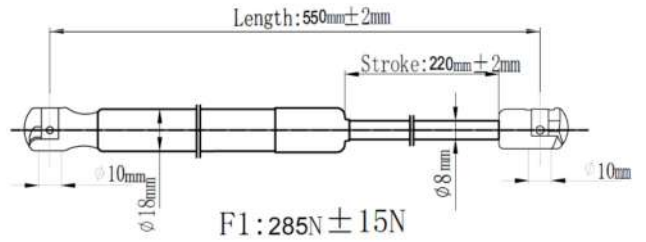

| | | |
|------------|----------|----------|
| Japanparts | Ashika | Japko |
| ZS03064 | ZSA03064 | ZSJ03064 |

O. E. M.: 1652828

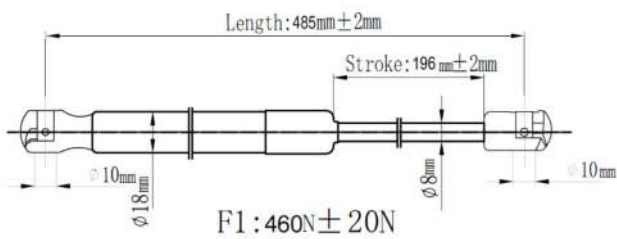

| | | |
|------------|----------|----------|
| Japanparts | Ashika | Japko |
| ZS03065 | ZSA03065 | ZSJ03065 |

O. E. M.: 83BBN406A10BB

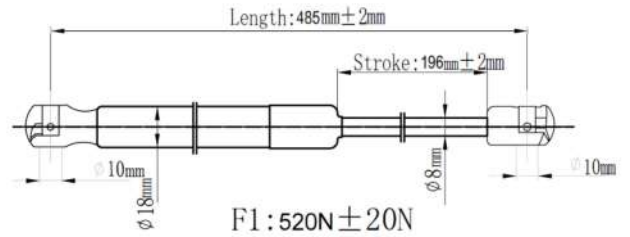

| | | |
|------------|----------|----------|
| Japanparts | Ashika | Japko |
| ZS03066 | ZSA03066 | ZSJ03066 |

O. E. M.: 6160980

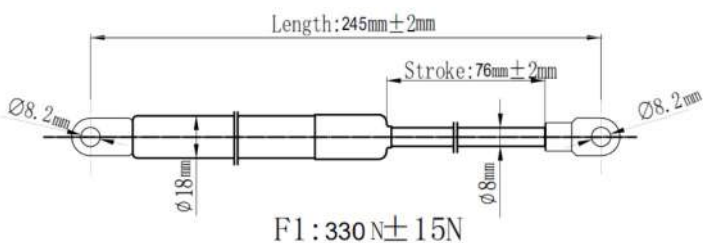

| | | |
|------------|----------|----------|
| Japanparts | Ashika | Japko |
| ZS03067 | ZSA03067 | ZSJ03067 |

O. E. M.: 1496160

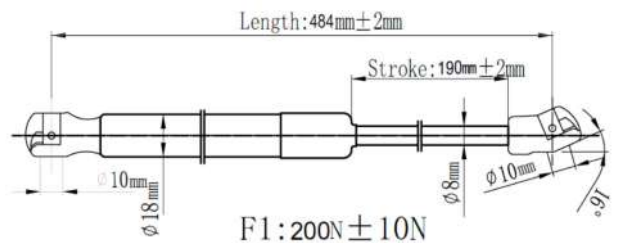

| | | |
|------------|----------|----------|
| Japanparts | Ashika | Japko |
| ZS03068 | ZSA03068 | ZSJ03068 |

O. E. M.: 1W6Z162826BA

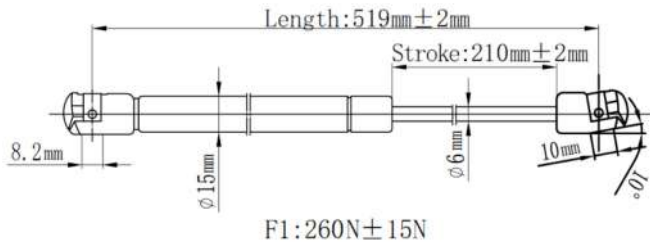

| | | |
|------------|----------|----------|
| Japanparts | Ashika | Japko |
| ZS03069 | ZSA03069 | ZSJ03069 |

O. E. M.: 3S4Z61406A10AA

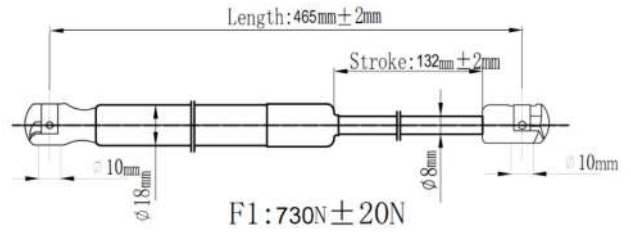

| | | |
|------------|----------|----------|
| Japanparts | Ashika | Japko |
| ZS03070 | ZSA03070 | ZSJ03070 |

O. E. M.: 5S43F706A10AA

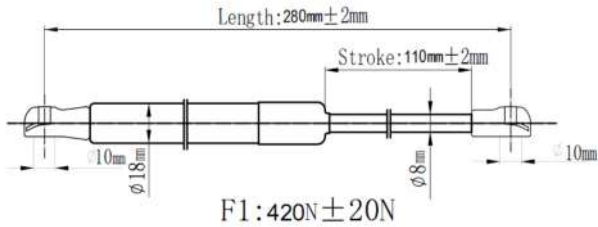

| | | |
|------------|----------|----------|
| Japanparts | Ashika | Japko |
| ZS03071 | ZSA03071 | ZSJ03071 |

O. E. M.: 6F9Z74406A10B

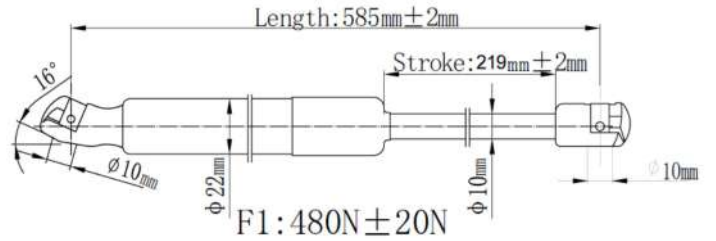

| | | |
|------------|----------|----------|
| Japanparts | Ashika | Japko |
| ZS03072 | ZSA03072 | ZSJ03072 |

O. E. M.: 6S65F406A10AA

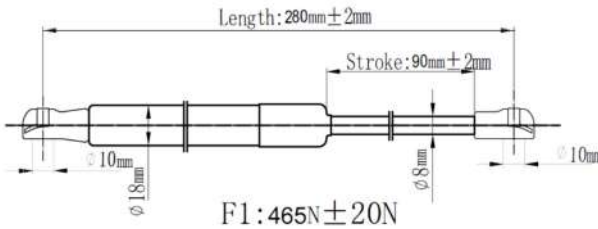

| | | |
|------------|----------|----------|
| Japanparts | Ashika | Japko |
| ZS03073 | ZSA03073 | ZSJ03073 |

O. E. M.: 8A8Z74406A10B

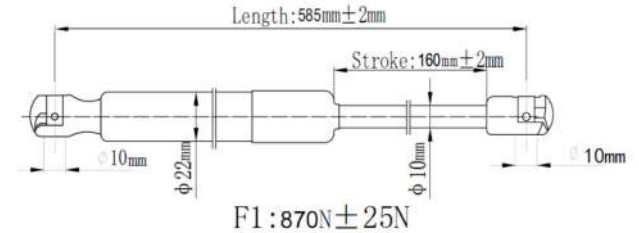

| | | |
|------------|----------|----------|
| Japanparts | Ashika | Japko |
| ZS03074 | ZSA03074 | ZSJ03074 |

O. E. M.: AG1354406A10BC

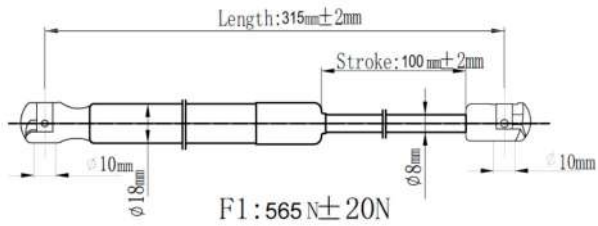

| | | |
|------------|----------|----------|
| Japanparts | Ashika | Japko |
| ZS03075 | ZSA03075 | ZSJ03075 |

O. E. M.: CJ54S406A10AC

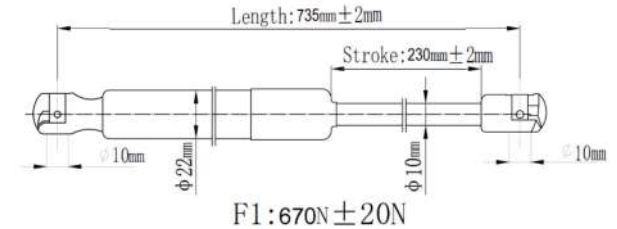

| | | |
|------------|----------|----------|
| Japanparts | Ashika | Japko |
| ZS03076 | ZSA03076 | ZSJ03076 |

O. E. M.: DG1354406A10AA

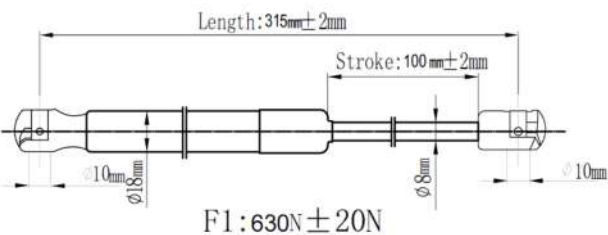

| | | |
|------------|----------|----------|
| Japanparts | Ashika | Japko |
| ZS03077 | ZSA03077 | ZSJ03077 |

O. E. M.: F37B7842104AA

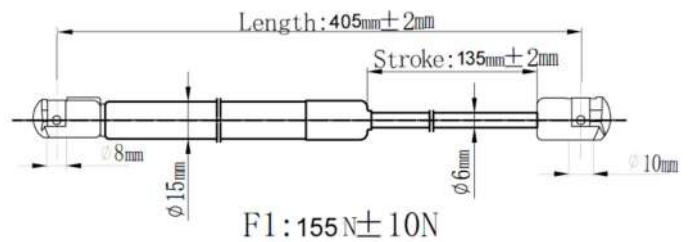

| | | |
|------------|----------|----------|
| Japanparts | Ashika | Japko |
| ZS03078 | ZSA03078 | ZSJ03078 |

O. E. M.: YC3578406A10AE

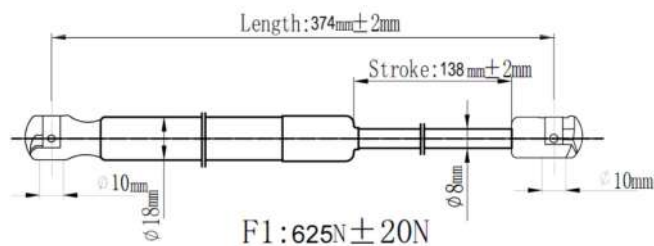

| | | |
|------------|----------|----------|
| Japanparts | Ashika | Japko |
| ZS03079 | ZSA03079 | ZSJ03079 |

O. E. M.: 1116028

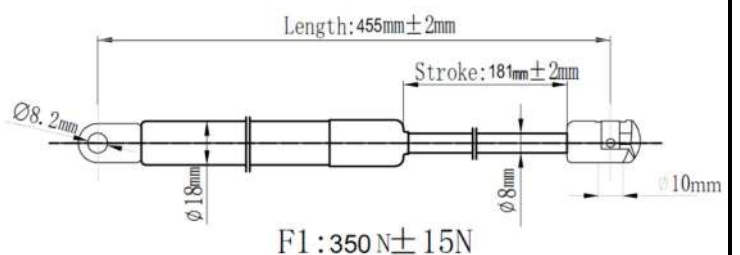

| | | |
|------------|----------|----------|
| Japanparts | Ashika | Japko |
| ZS03080 | ZSA03080 | ZSJ03080 |

O. E. M.: 1C16V406A10DC

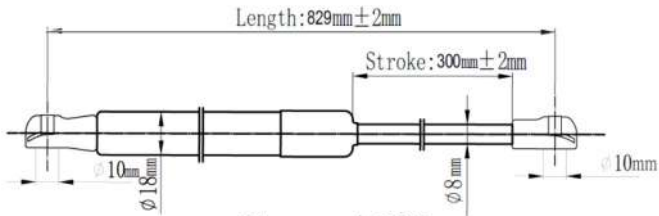

F1 : 640N ± 20N

| | | |
|------------|----------|----------|
| Japanparts | Ashika | Japko |
| ZS03081 | ZSA03081 | ZSJ03081 |

O. E. M.: 7E5354406A10

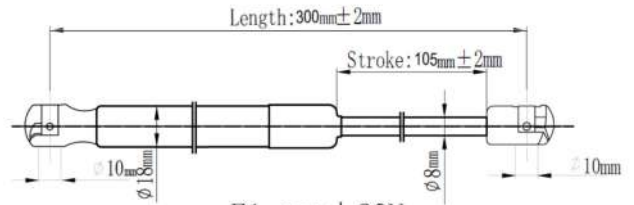

F1 : 540N ± 20N

| | | |
|------------|----------|----------|
| Japanparts | Ashika | Japko |
| ZS03082 | ZSA03082 | ZSJ03082 |

O. E. M.: 6W7Z16C826AA

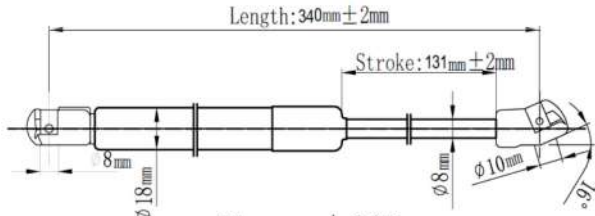

F1 : 600N ± 20N

| | | |
|------------|----------|----------|
| Japanparts | Ashika | Japko |
| ZS03083 | ZSA03083 | ZSJ03083 |

O. E. M.: 2F1Z16C826BA

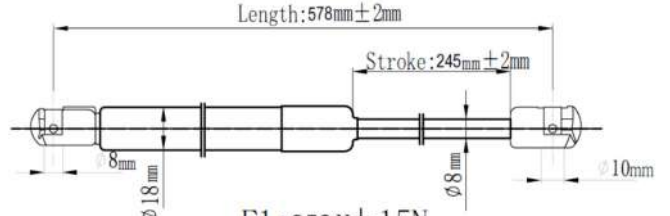

F1 : 250N ± 15N

| | | |
|------------|----------|----------|
| Japanparts | Ashika | Japko |
| ZS03084 | ZSA03084 | ZSJ03084 |

O. E. M.: 3F2Z17406A10AA

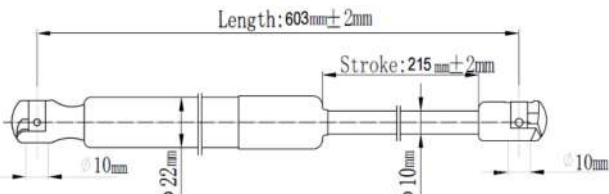

F1 : 712N ± 20N

| | | |
|------------|----------|----------|
| Japanparts | Ashika | Japko |
| ZS03085 | ZSA03085 | ZSJ03085 |

O. E. M.: 4F2Z17406A10

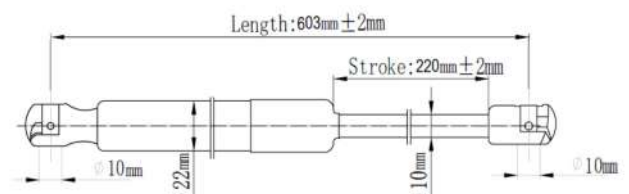

F1 : 700N ± 20N

| | | |
|------------|----------|----------|
| Japanparts | Ashika | Japko |
| ZS03086 | ZSA03086 | ZSJ03086 |

O. E. M.: 5G1Z54406A10AA

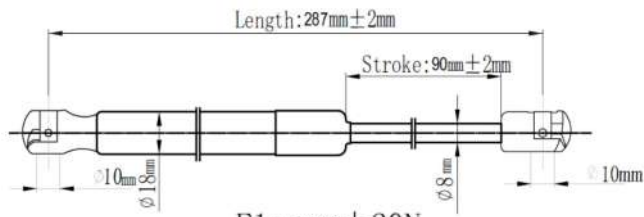

F1 : 570N ± 20N

| | | |
|------------|----------|----------|
| Japanparts | Ashika | Japko |
| ZS03087 | ZSA03087 | ZSJ03087 |

O. E. M.: 31297156

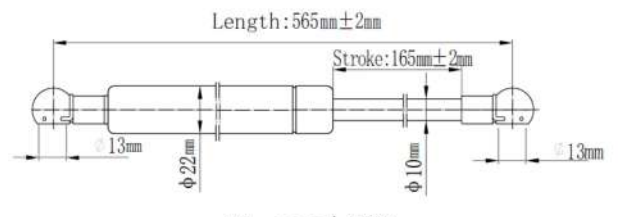

F1 : 620N ± 20N

| | | |
|------------|----------|----------|
| Japanparts | Ashika | Japko |
| ZS03088 | ZSA03088 | ZSJ03088 |

O. E. M.: 3211734

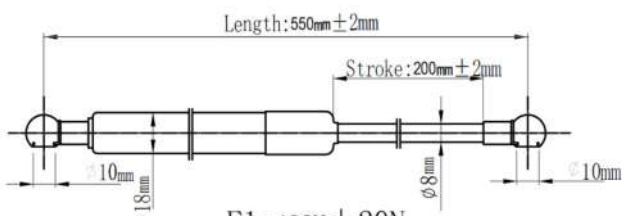

F1 : 460N ± 20N

| | | |
|------------|----------|----------|
| Japanparts | Ashika | Japko |
| ZS03089 | ZSA03089 | ZSJ03089 |

O. E. M.: 9485706

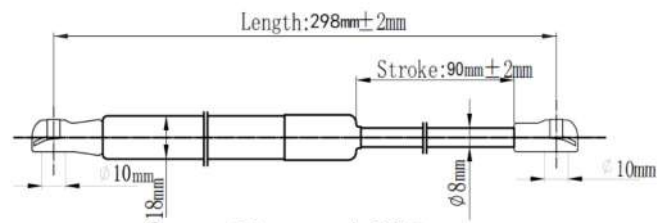

F1 : 600N ± 20N

| | | |
|------------|----------|----------|
| Japanparts | Ashika | Japko |
| ZS03090 | ZSA03090 | ZSJ03090 |

O. E. M.: 30803472

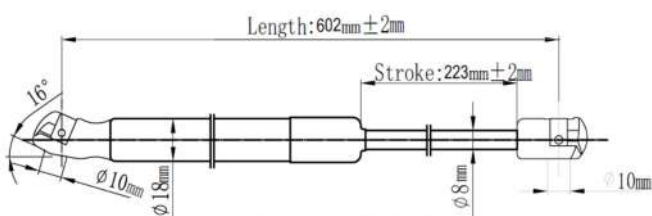

F1 : 320N ± 15N

| | | |
|------------|----------|----------|
| Japanparts | Ashika | Japko |
| ZS03091 | ZSA03091 | ZSJ03091 |

O. E. M.: 3509350

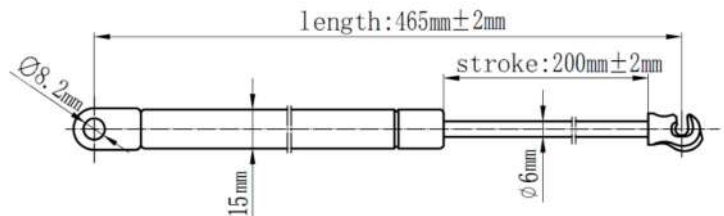

F1 : 300N ± 15N

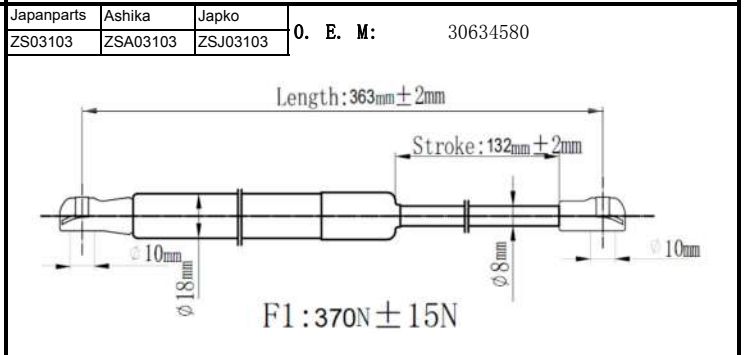
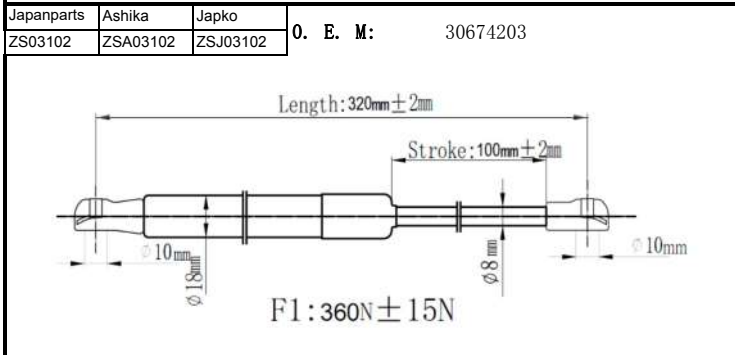
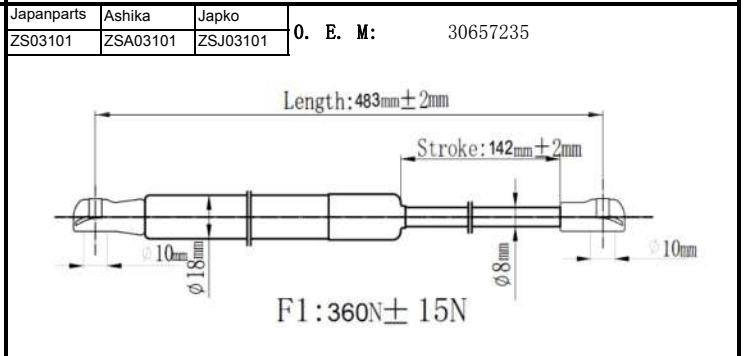
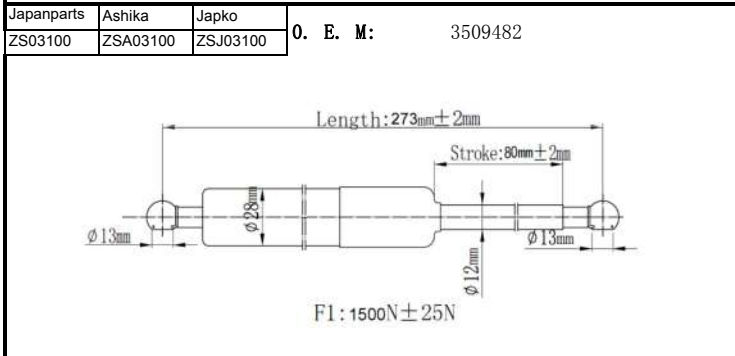
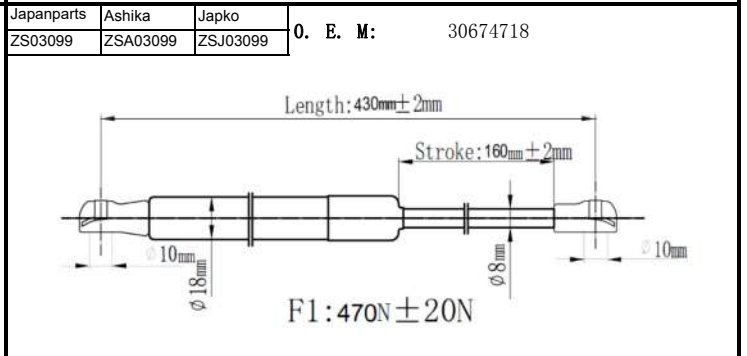
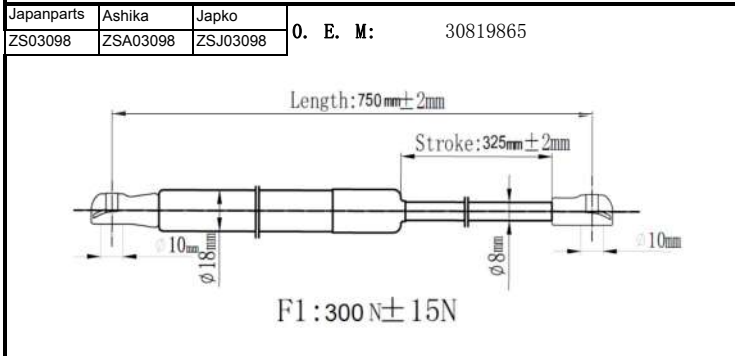
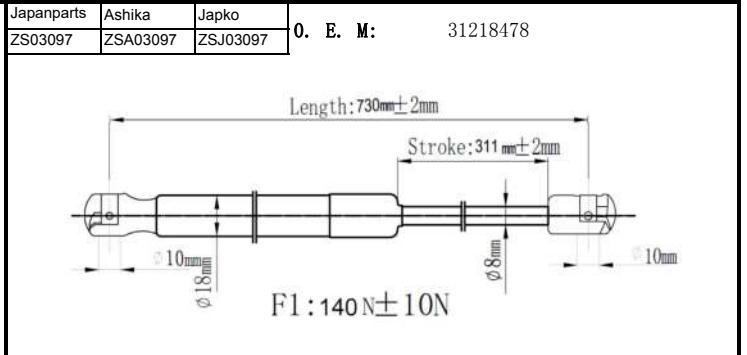
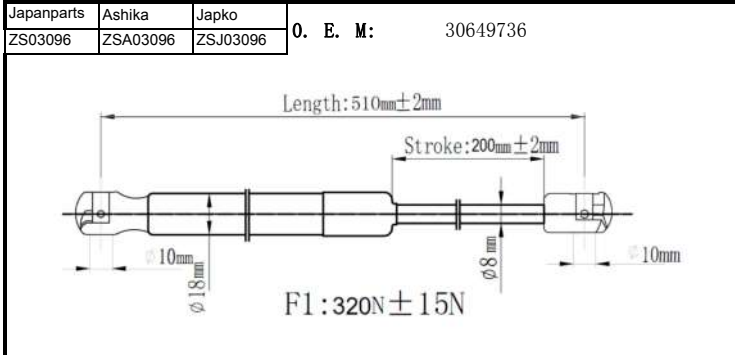
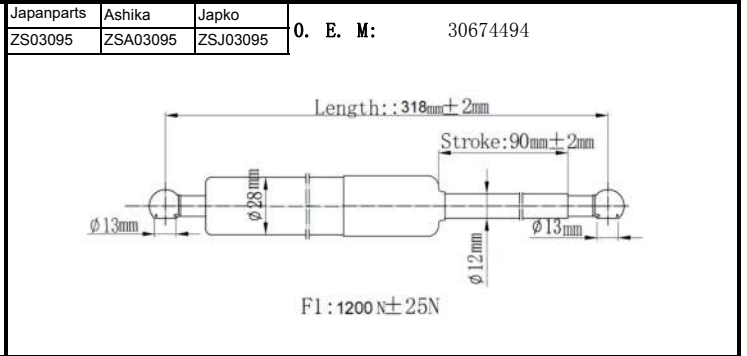
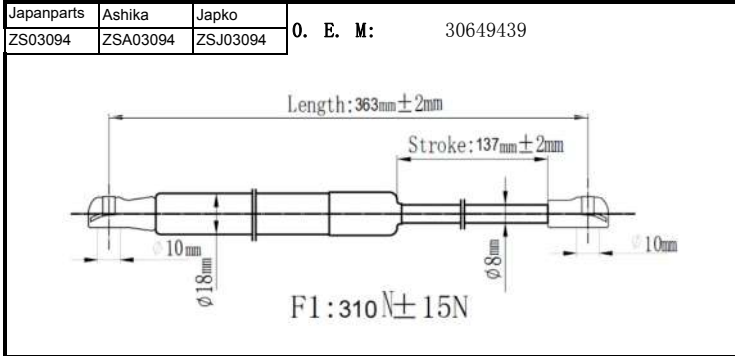
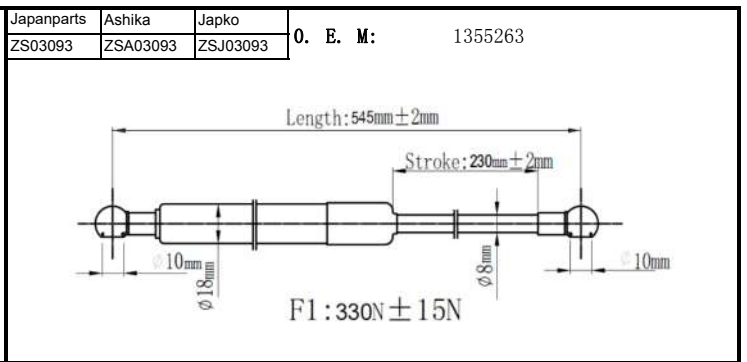
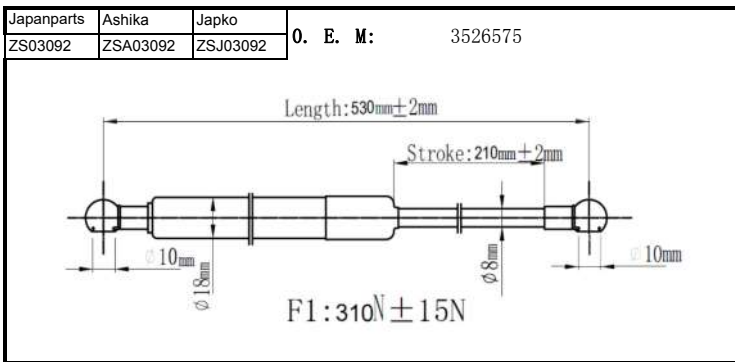

| | | |
|------------|----------|----------|
| Japanparts | Ashika | Japko |
| ZS03104 | ZSA03104 | ZSJ03104 |

O. E. M.: 30649836

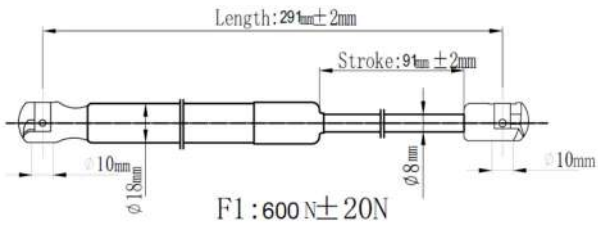

| | | |
|------------|----------|----------|
| Japanparts | Ashika | Japko |
| ZS03105 | ZSA03105 | ZSJ03105 |

O. E. M.: 30674836

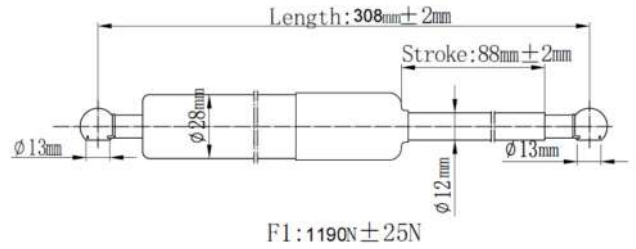

| | | |
|------------|----------|----------|
| Japanparts | Ashika | Japko |
| ZS03106 | ZSA03106 | ZSJ03106 |

O. E. M.: 30649516

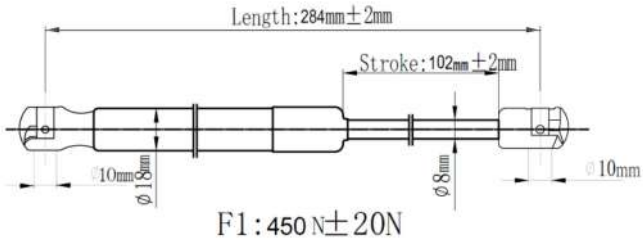

| | | |
|------------|----------|----------|
| Japanparts | Ashika | Japko |
| ZS03107 | ZSA03107 | ZSJ03107 |

O. E. M.: 30784935

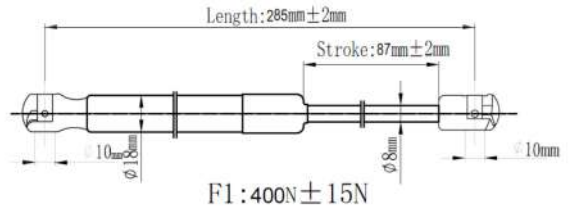

| | | |
|------------|----------|----------|
| Japanparts | Ashika | Japko |
| ZS03108 | ZSA03108 | ZSJ03108 |

O. E. M.: 31278769

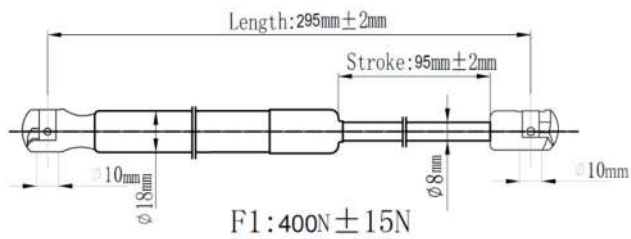

| | | |
|------------|----------|----------|
| Japanparts | Ashika | Japko |
| ZS03109 | ZSA03109 | ZSJ03109 |

O. E. M.: 30716057

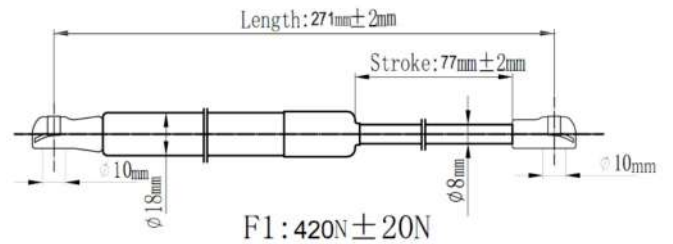

| | | |
|------------|----------|----------|
| Japanparts | Ashika | Japko |
| ZS03110 | ZSA03110 | ZSJ03110 |

O. E. M.: 9154605

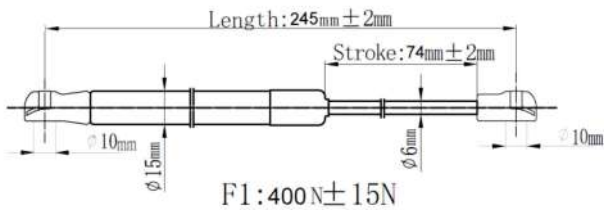

| | | |
|------------|----------|----------|
| Japanparts | Ashika | Japko |
| ZS03111 | ZSA03111 | ZSJ03111 |

O. E. M.: 688476

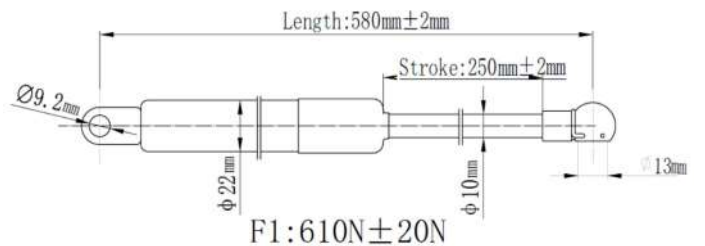

| | | |
|------------|----------|----------|
| Japanparts | Ashika | Japko |
| ZS03112 | ZSA03112 | ZSJ03112 |

O. E. M.: 31278560

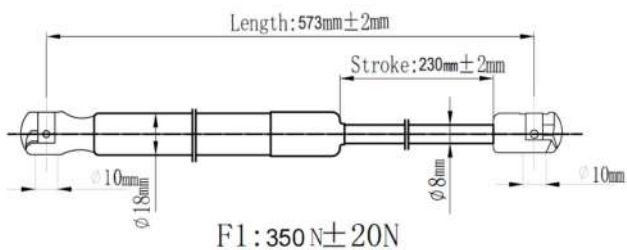

| | | |
|------------|----------|----------|
| Japanparts | Ashika | Japko |
| ZS03113 | ZSA03113 | ZSJ03113 |

O. E. M.: 31298337

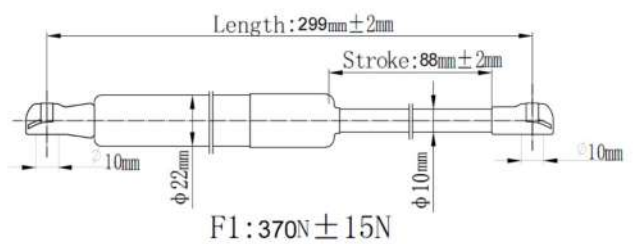

| | | |
|------------|----------|----------|
| Japanparts | Ashika | Japko |
| ZS03114 | ZSA03114 | ZSJ03114 |

O. E. M.: 31333127

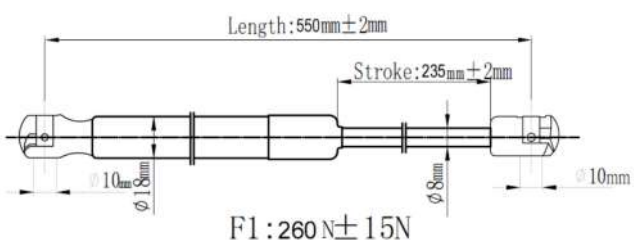

| | | |
|------------|----------|----------|
| Japanparts | Ashika | Japko |
| ZS03115 | ZSA03115 | ZSJ03115 |

O. E. M.: 470348

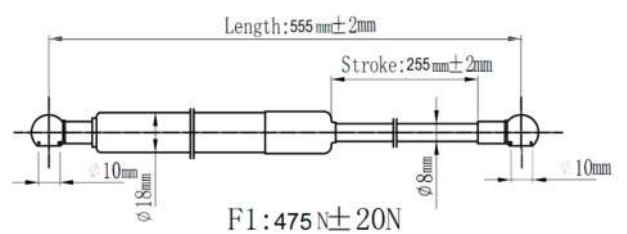

| | | |
|------------|----------|----------|
| Japanparts | Ashika | Japko |
| ZS03116 | ZSA03116 | ZSJ03116 |

O. E. M.: 1254916

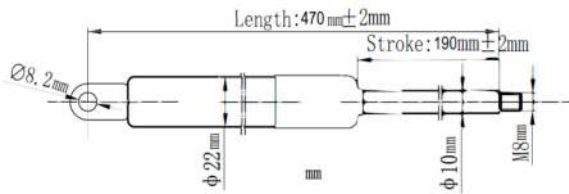

F1: 400N ± 20N

| | | |
|------------|----------|----------|
| Japanparts | Ashika | Japko |
| ZS03117 | ZSA03117 | ZSJ03117 |

O. E. M.: 9187795

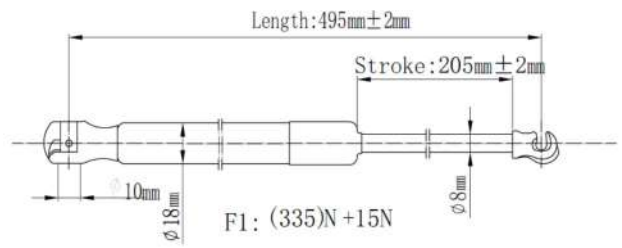

F1: (335)N + 15N

| | | |
|------------|----------|----------|
| Japanparts | Ashika | Japko |
| ZS03118 | ZSA03118 | ZSJ03118 |

O. E. M.: 1334648

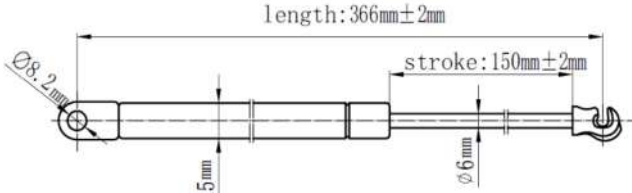

F1: 290N ± 15N

| | | |
|------------|----------|----------|
| Japanparts | Ashika | Japko |
| ZS03119 | ZSA03119 | ZSJ03119 |

O. E. M.: 8618640

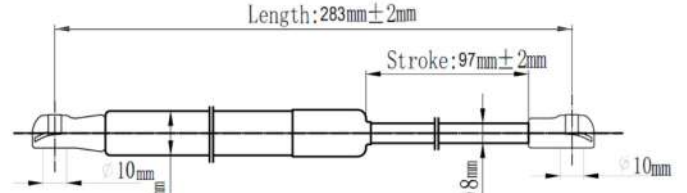

F1: 740N ± 20N

| | | |
|------------|----------|----------|
| Japanparts | Ashika | Japko |
| ZS03124 | ZSA03124 | ZSJ03124 |

O. E. M.: 31420214

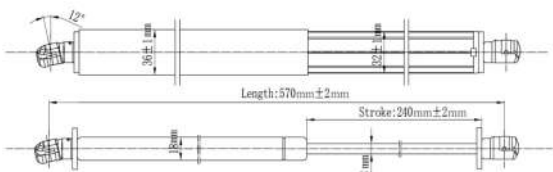

F1: 710N ± 20N

| | | |
|------------|----------|----------|
| Japanparts | Ashika | Japko |
| ZS03125 | ZSA03125 | ZSJ03125 |

O. E. M.: CJ5Z78406A10B

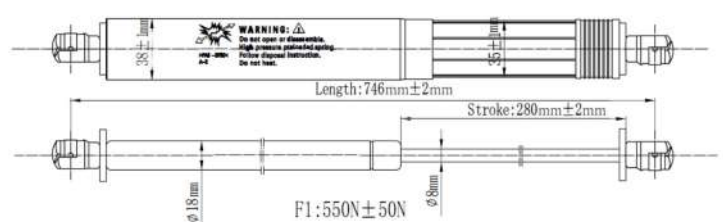

F1: 550N ± 50N

| | | |
|------------|----------|----------|
| Japanparts | Ashika | Japko |
| ZS03126 | ZSA03126 | ZSJ03126 |

O. E. M.: DS73N402A74AC

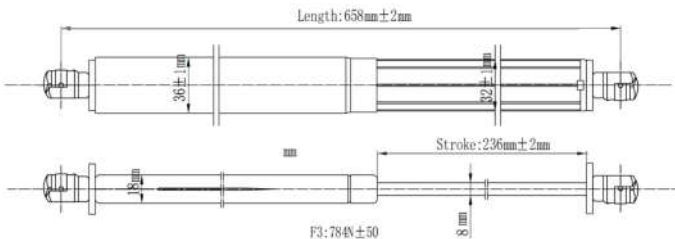

F3: 784N ± 50

| | | |
|------------|----------|----------|
| Japanparts | Ashika | Japko |
| ZS04000 | ZSA04000 | ZSJ04000 |

O. E. M.: 132718

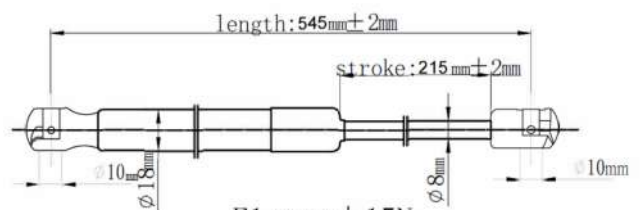

F1: 360N ± 15N

| | | |
|------------|----------|----------|
| Japanparts | Ashika | Japko |
| ZS04001 | ZSA04001 | ZSJ04001 |

O. E. M.: 132711

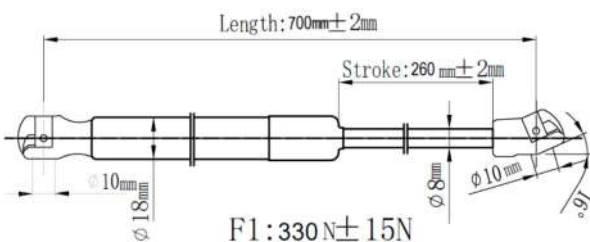

F1: 330N ± 15N

| | | |
|------------|----------|----------|
| Japanparts | Ashika | Japko |
| ZS04002 | ZSA04002 | ZSJ04002 |

O. E. M.: 25796762

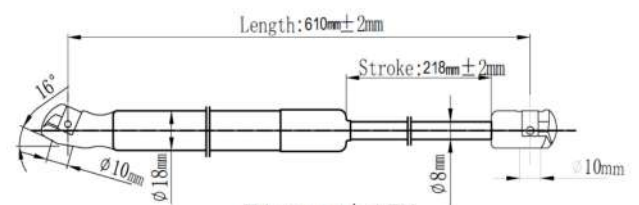

F1: 230N ± 15N

| | | |
|------------|----------|----------|
| Japanparts | Ashika | Japko |
| ZS04003 | ZSA04003 | ZSJ04003 |

O. E. M.: 132727

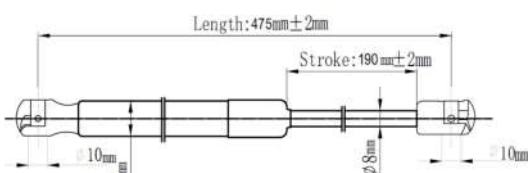

F1: 560N ± 15N

| | | |
|------------|----------|----------|
| Japanparts | Ashika | Japko |
| ZS04004 | ZSA04004 | ZSJ04004 |

O. E. M.: 132725

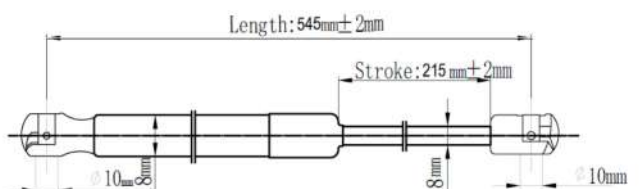

F1: 360N ± 15N

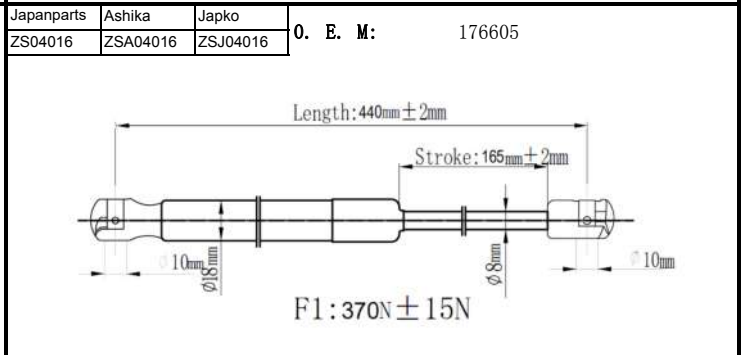
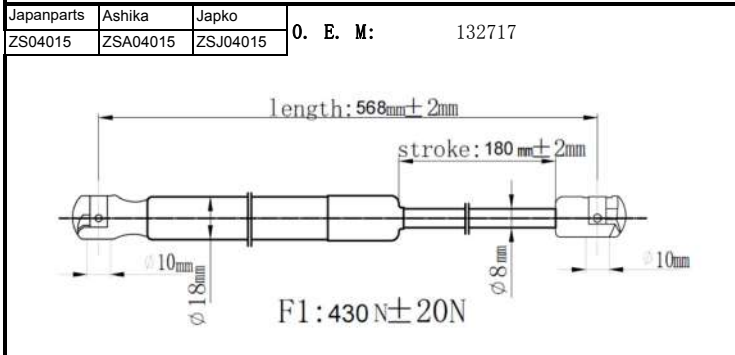
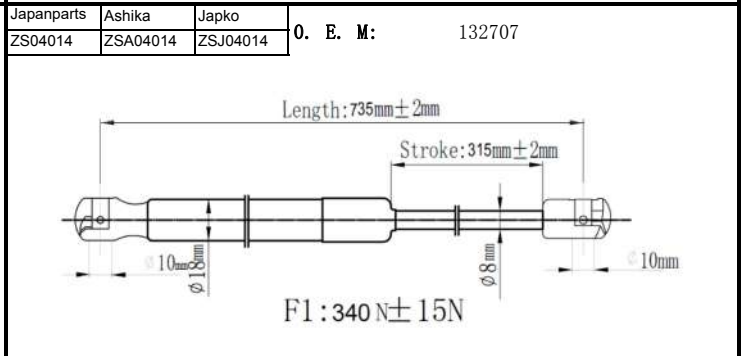
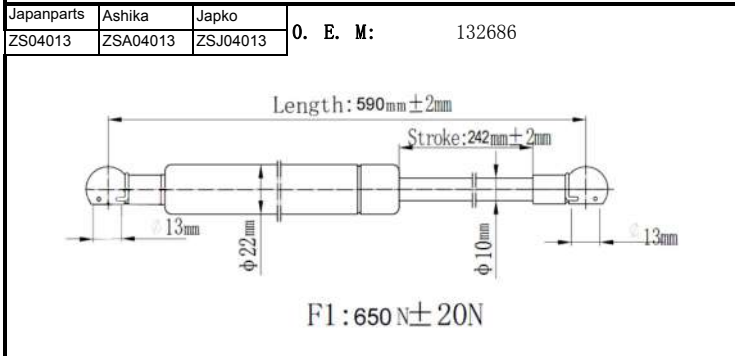
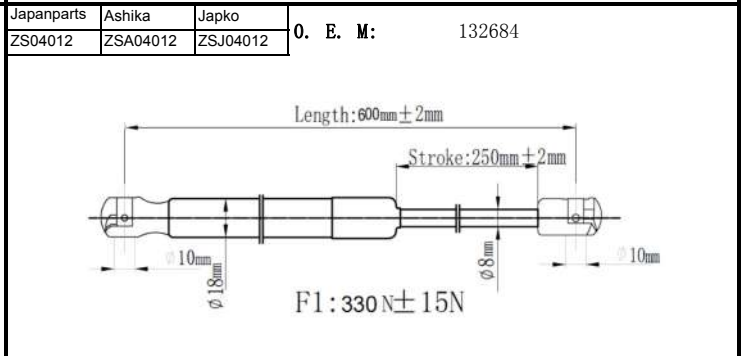
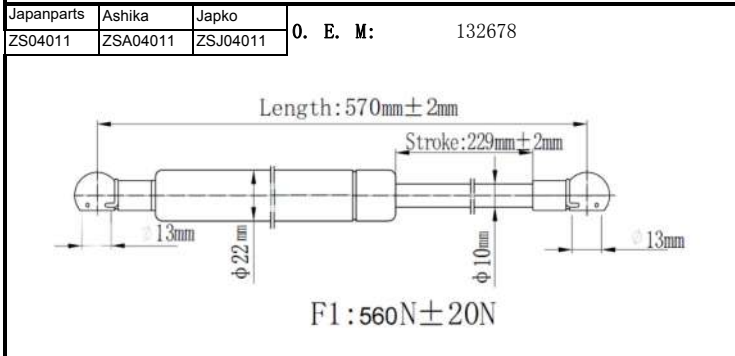
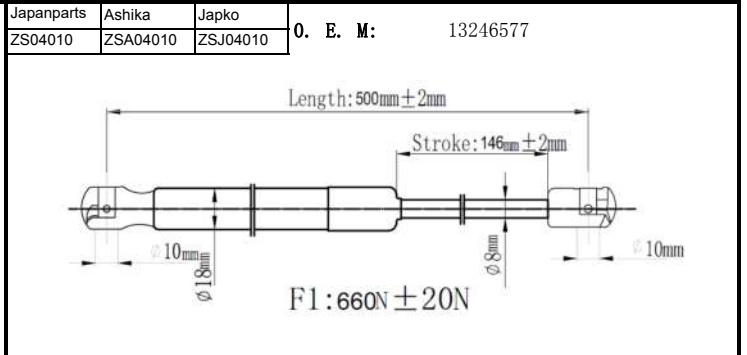
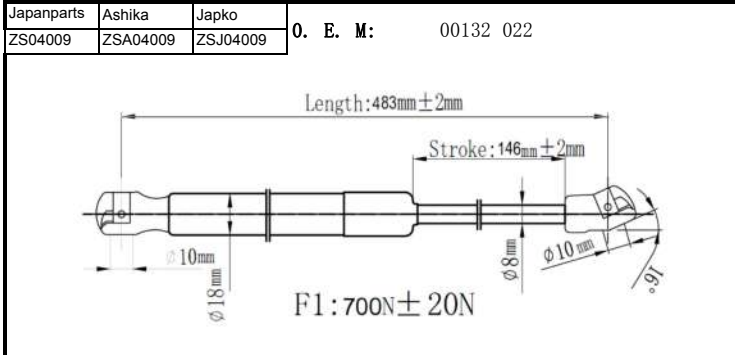
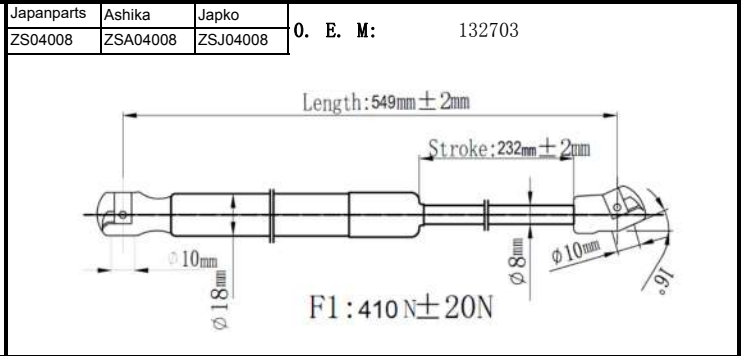
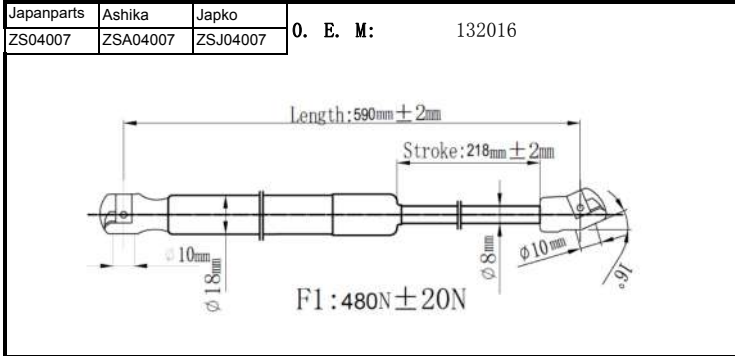
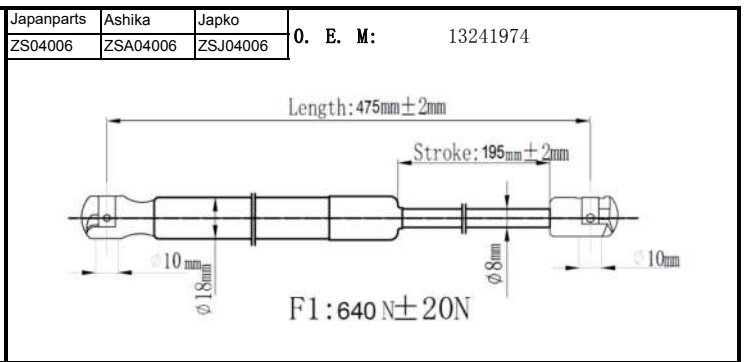
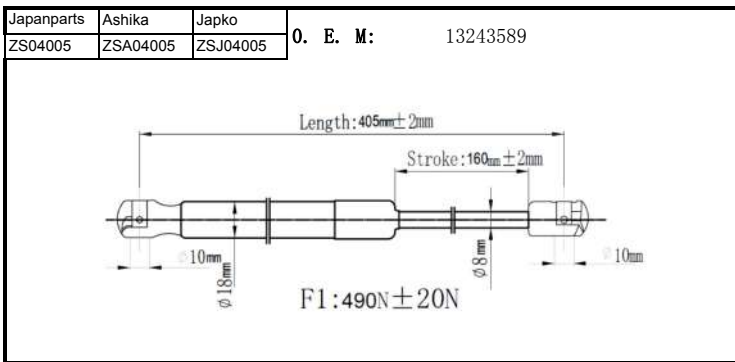

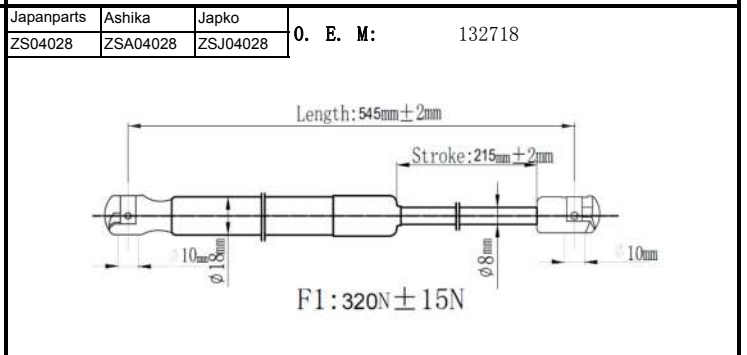
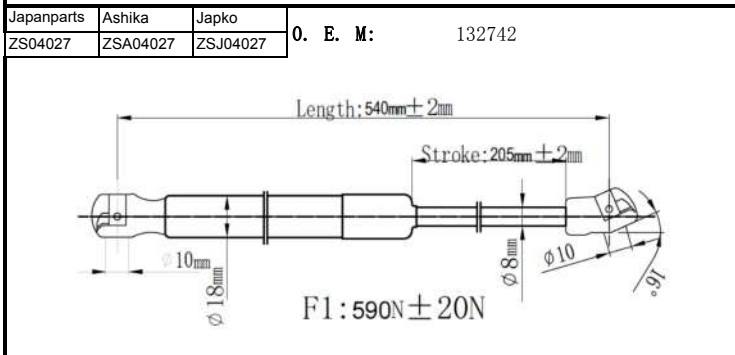
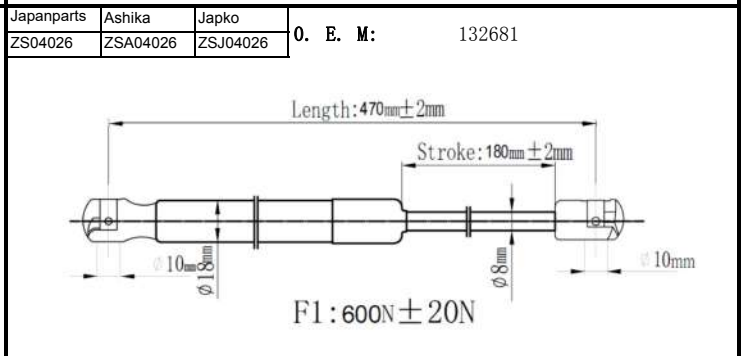
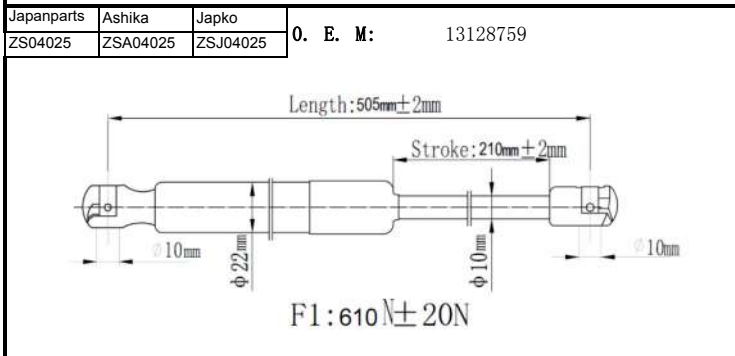
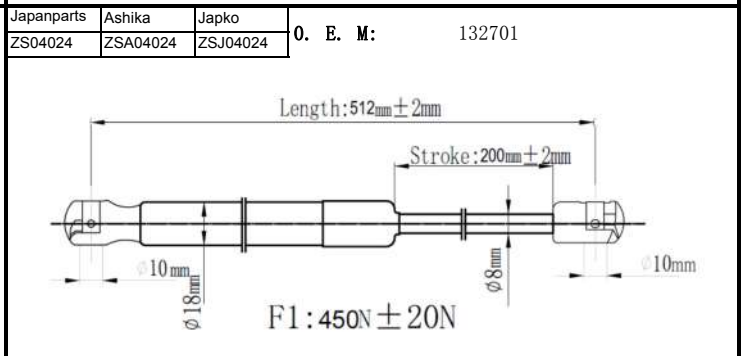
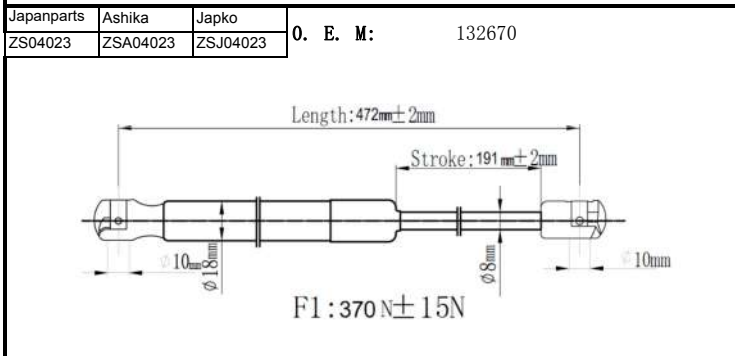
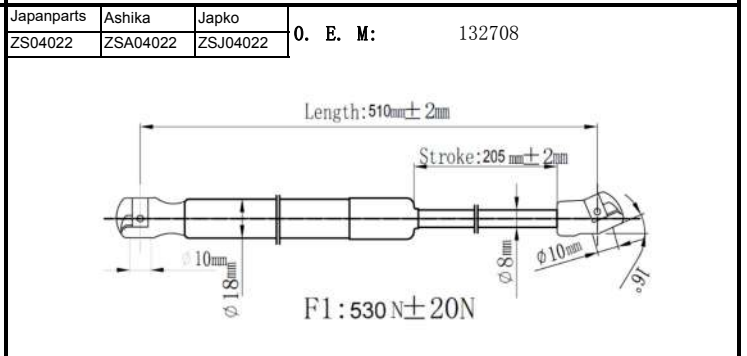
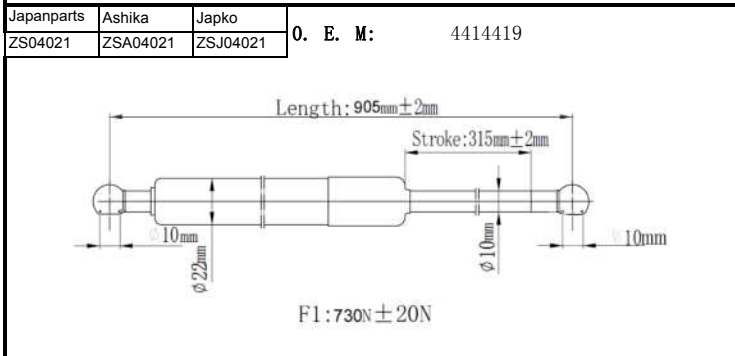
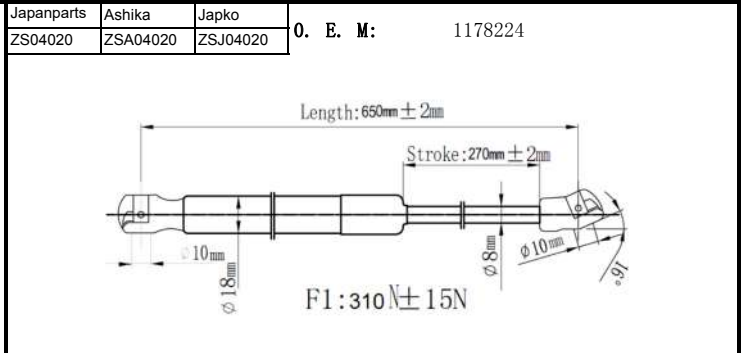
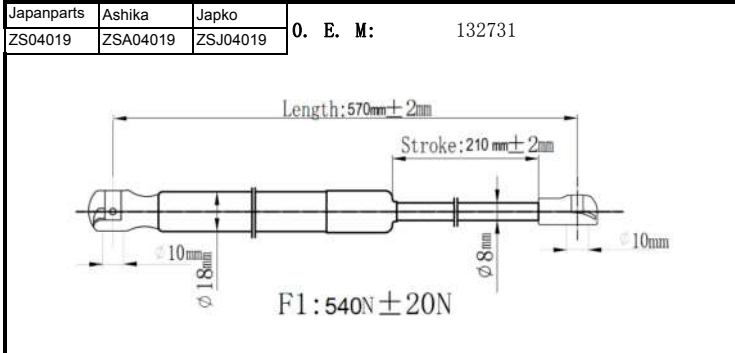
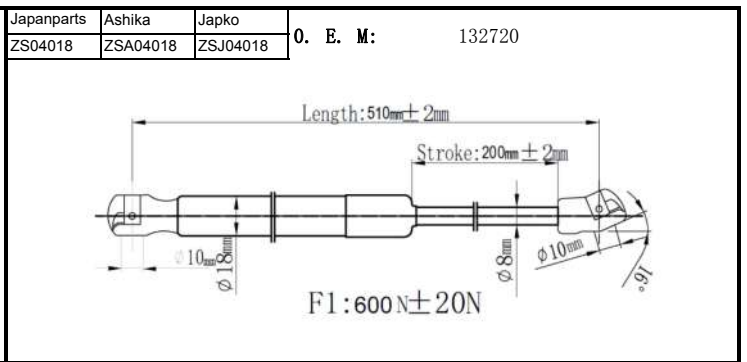
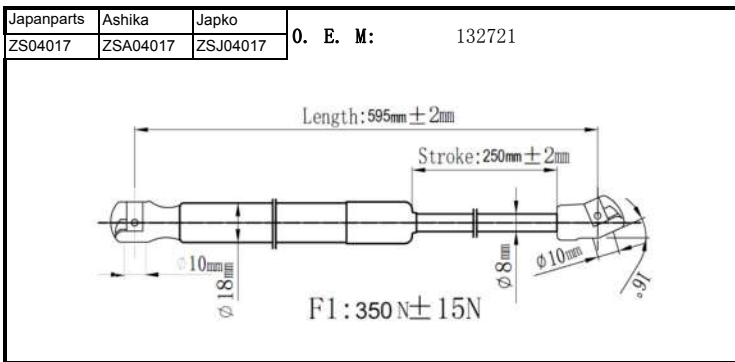

| | | |
|------------|----------|----------|
| Japanparts | Ashika | Japko |
| ZS04029 | ZSA04029 | ZSJ04029 |

O. E. M: 13122695

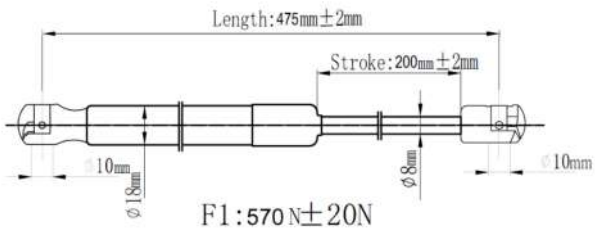

| | | |
|------------|----------|----------|
| Japanparts | Ashika | Japko |
| ZS04030 | ZSA04030 | ZSJ04030 |

O. E. M: 132532

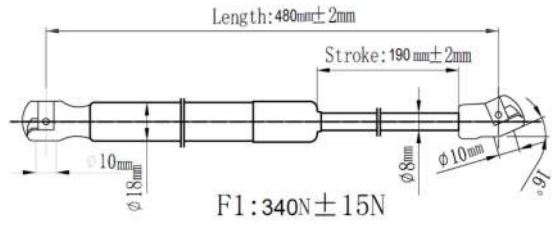

| | | |
|------------|----------|----------|
| Japanparts | Ashika | Japko |
| ZS04031 | ZSA04031 | ZSJ04031 |

O. E. M: 13182309

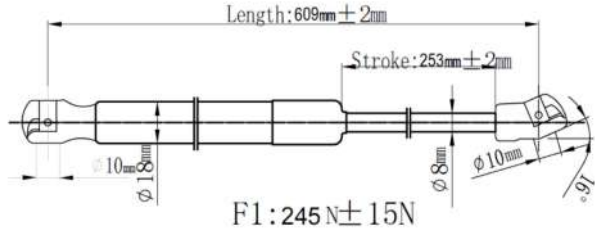

| | | |
|------------|----------|----------|
| Japanparts | Ashika | Japko |
| ZS04032 | ZSA04032 | ZSJ04032 |

O. E. M: 132715

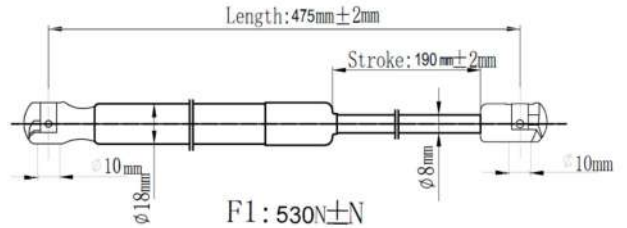

| | | |
|------------|----------|----------|
| Japanparts | Ashika | Japko |
| ZS04033 | ZSA04033 | ZSJ04033 |

O. E. M: 176607

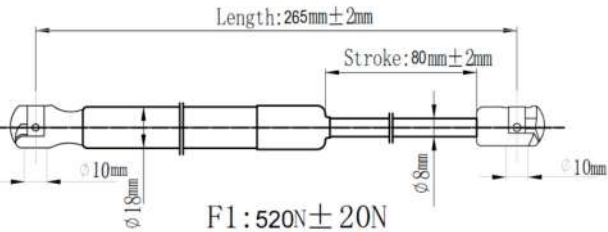

| | | |
|------------|----------|----------|
| Japanparts | Ashika | Japko |
| ZS04034 | ZSA04034 | ZSJ04034 |

O. E. M: 1178224

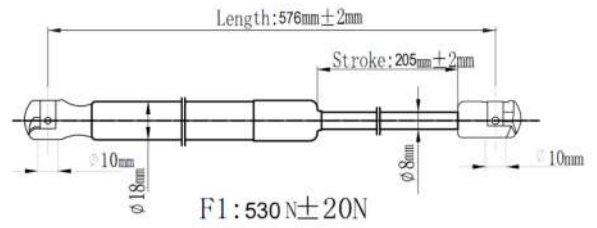

| | | |
|------------|----------|----------|
| Japanparts | Ashika | Japko |
| ZS04035 | ZSA04035 | ZSJ04035 |

O. E. M: 90275080

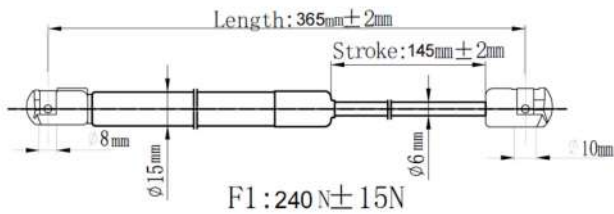

| | | |
|------------|----------|----------|
| Japanparts | Ashika | Japko |
| ZS04036 | ZSA04036 | ZSJ04036 |

O. E. M: 1180016

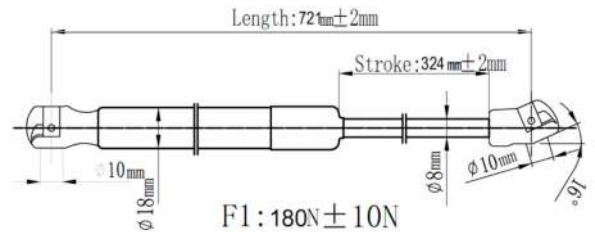

| | | |
|------------|----------|----------|
| Japanparts | Ashika | Japko |
| ZS04037 | ZSA04037 | ZSJ04037 |

O. E. M: 132726

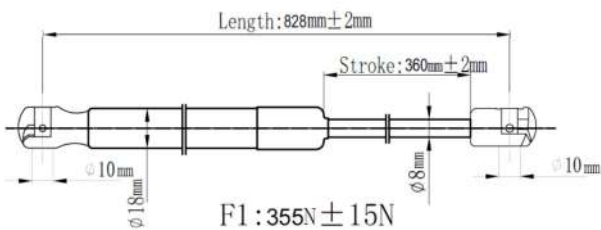

| | | |
|------------|----------|----------|
| Japanparts | Ashika | Japko |
| ZS04038 | ZSA04038 | ZSJ04038 |

O. E. M: 5132267

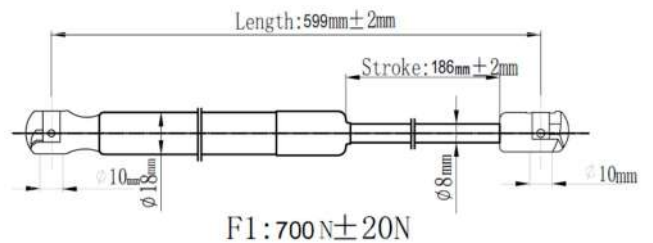

| | | |
|------------|----------|----------|
| Japanparts | Ashika | Japko |
| ZS04039 | ZSA04039 | ZSJ04039 |

O. E. M: 132531

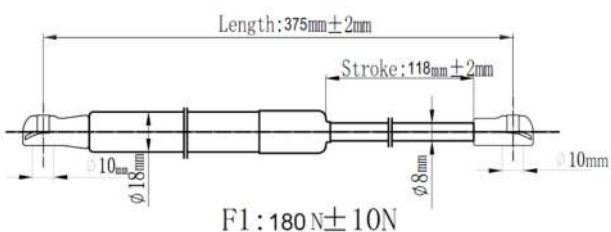

| | | |
|------------|----------|----------|
| Japanparts | Ashika | Japko |
| ZS04040 | ZSA04040 | ZSJ04040 |

O. E. M: 1180403

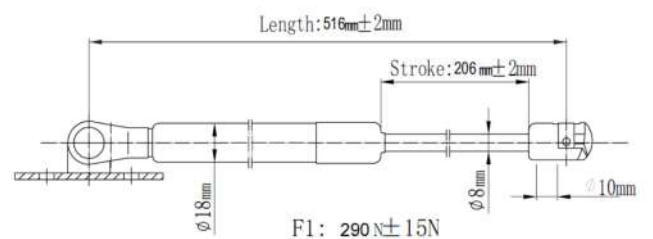

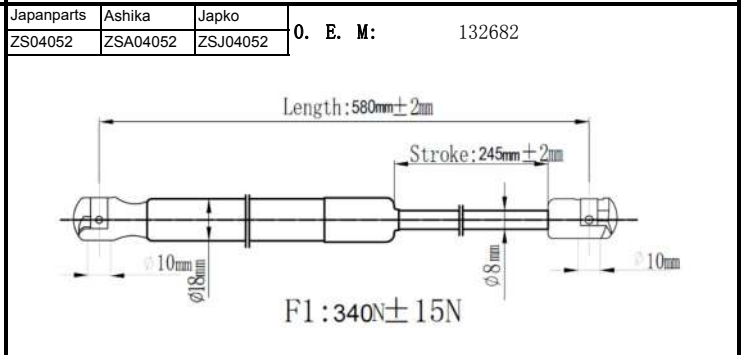
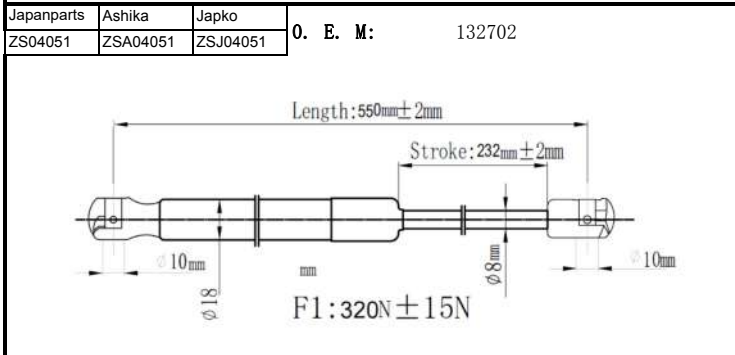
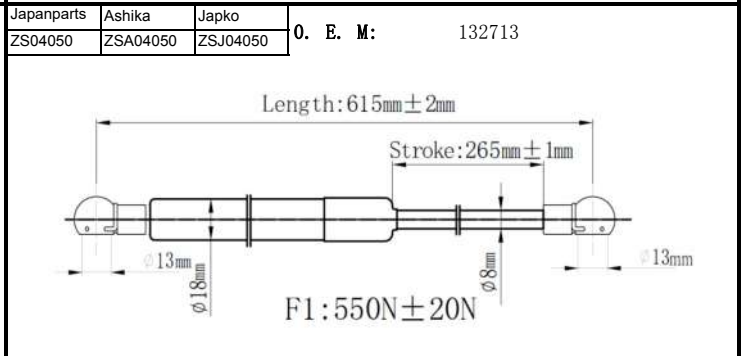
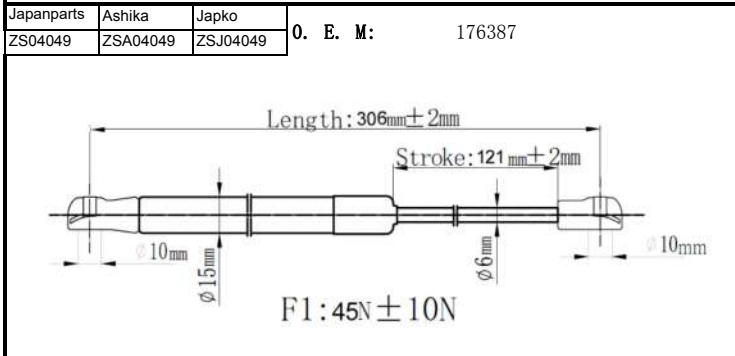
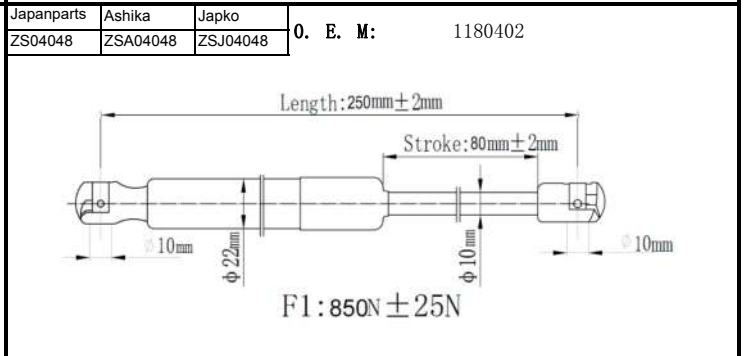
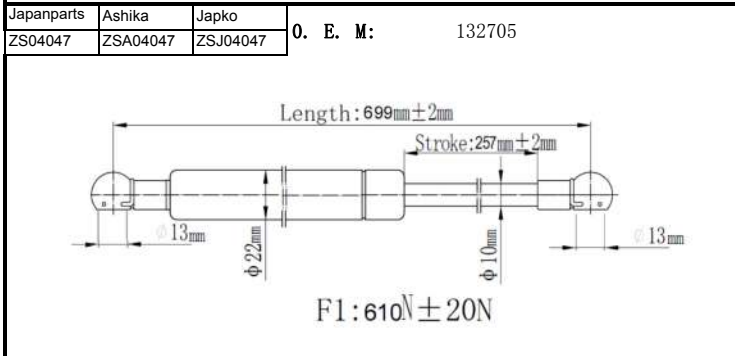
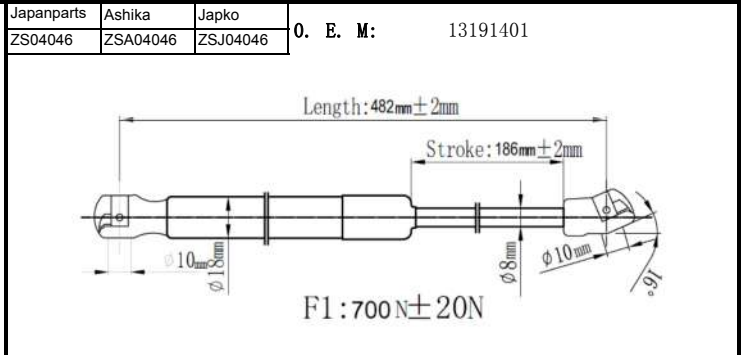
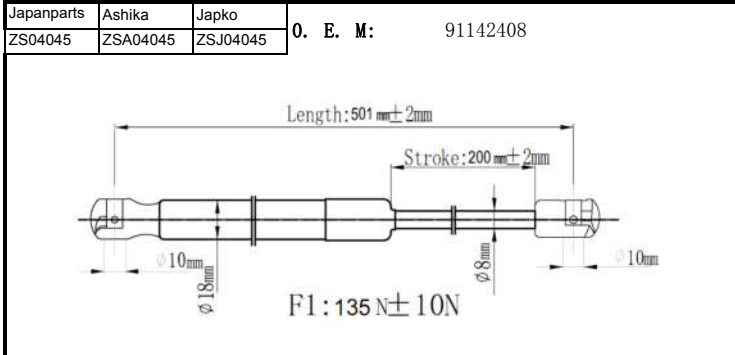
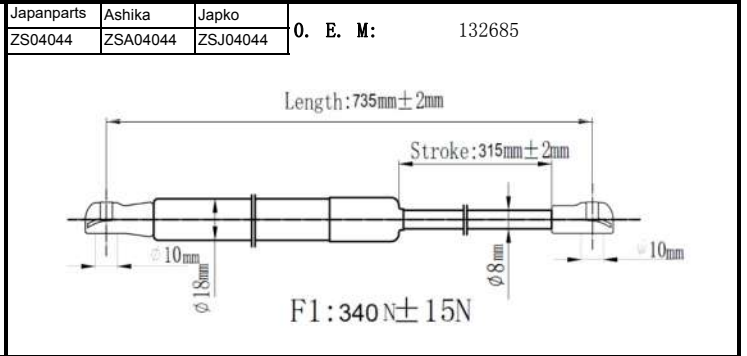
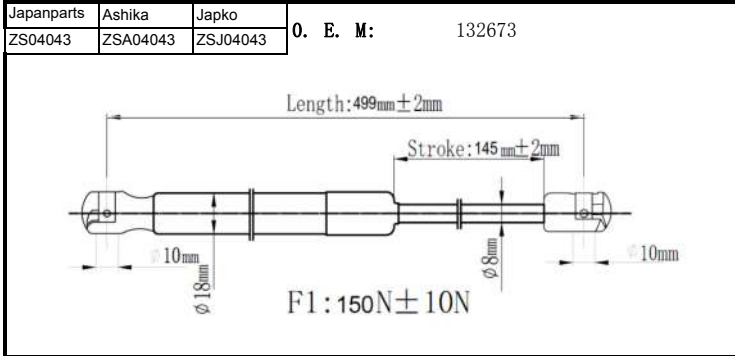
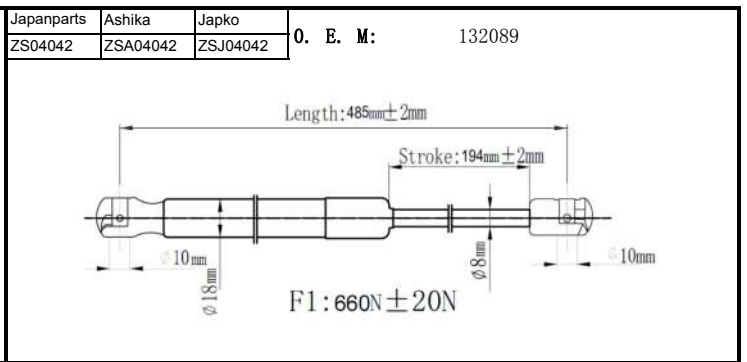
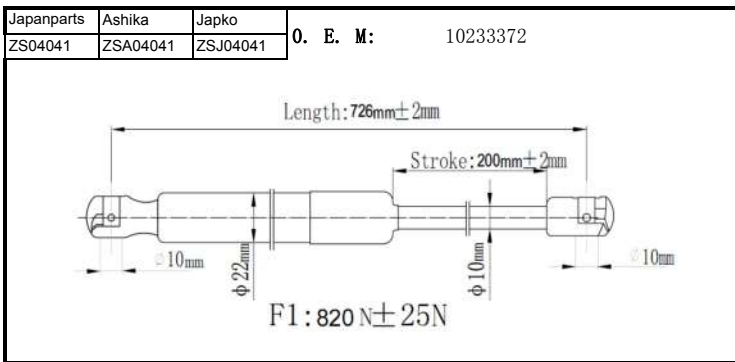

| | | |
|------------|----------|----------|
| Japanparts | Ashika | Japko |
| ZS04053 | ZSA04053 | ZSJ04053 |

O. E. M: 132119

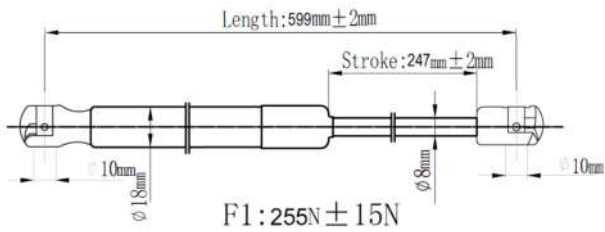

F1 : 255N ± 15N

| | | |
|------------|----------|----------|
| Japanparts | Ashika | Japko |
| ZS04054 | ZSA04054 | ZSJ04054 |

O. E. M: 9231796

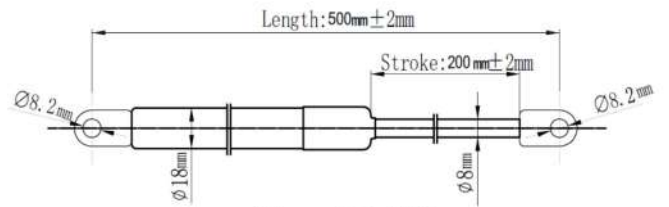

F1 : 600N ± 20N

| | | |
|------------|----------|----------|
| Japanparts | Ashika | Japko |
| ZS04055 | ZSA04055 | ZSJ04055 |

O. E. M: 104854717

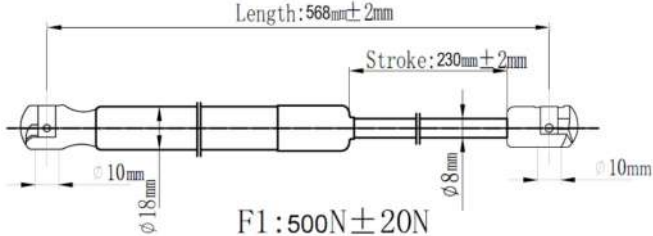

F1 : 500N ± 20N

| | | |
|------------|----------|----------|
| Japanparts | Ashika | Japko |
| ZS04056 | ZSA04056 | ZSJ04056 |

O. E. M: 4854741

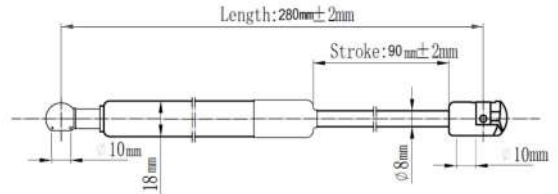

F1 : 680N ± 20N

| | | |
|------------|----------|----------|
| Japanparts | Ashika | Japko |
| ZS04057 | ZSA04057 | ZSJ04057 |

O. E. M: 127850021

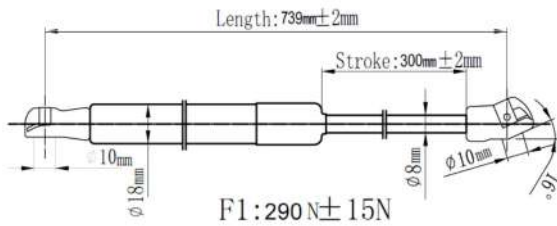

F1 : 290N ± 15N

| | | |
|------------|----------|----------|
| Japanparts | Ashika | Japko |
| ZS04058 | ZSA04058 | ZSJ04058 |

O. E. M: 4554733

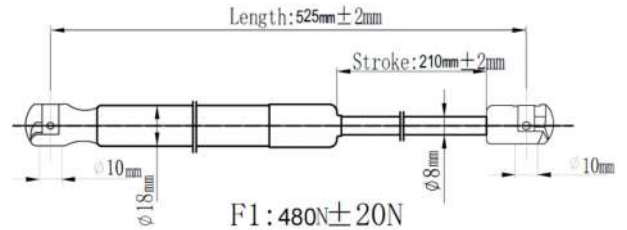

F1 : 480N ± 20N

| | | |
|------------|----------|----------|
| Japanparts | Ashika | Japko |
| ZS04059 | ZSA04059 | ZSJ04059 |

O. E. M: 12768264

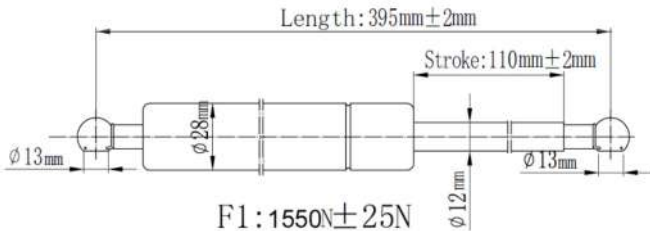

F1 : 1550N ± 25N

| | | |
|------------|----------|----------|
| Japanparts | Ashika | Japko |
| ZS04060 | ZSA04060 | ZSJ04060 |

O. E. M: 12778556

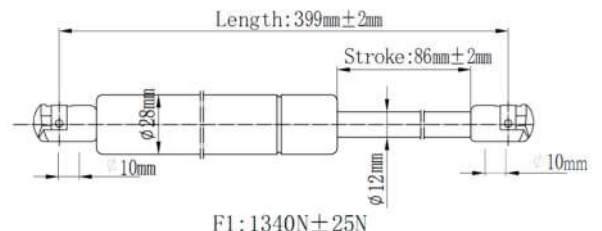

F1 : 1340N ± 25N

| | | |
|------------|----------|----------|
| Japanparts | Ashika | Japko |
| ZS04061 | ZSA04061 | ZSJ04061 |

O. E. M: 30521738

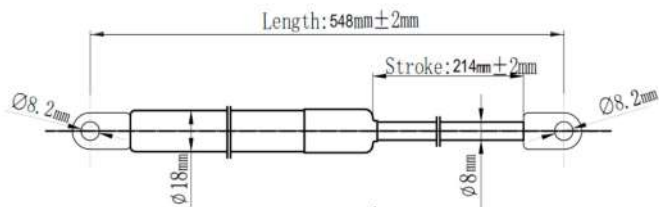

F1 : 225N ± 15N

| | | |
|------------|----------|----------|
| Japanparts | Ashika | Japko |
| ZS04062 | ZSA04062 | ZSJ04062 |

O. E. M: 12831543

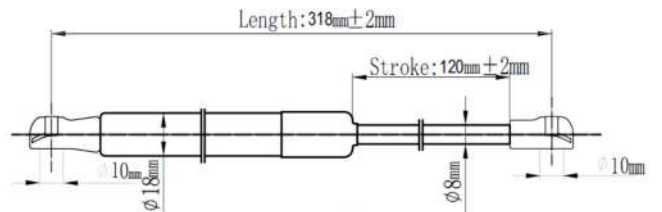

F1 : 380N ± 15N

| | | |
|------------|----------|----------|
| Japanparts | Ashika | Japko |
| ZS04063 | ZSA04063 | ZSJ04063 |

O. E. M: 9293580

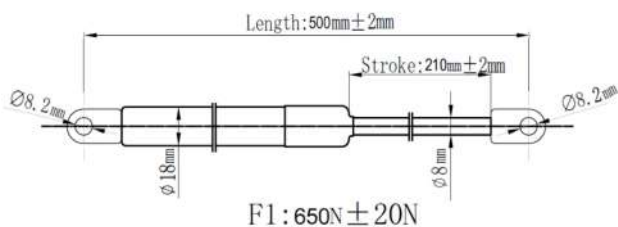

F1 : 650N ± 20N

| | | |
|------------|----------|----------|
| Japanparts | Ashika | Japko |
| ZS04064 | ZSA04064 | ZSJ04064 |

O. E. M: 4326468

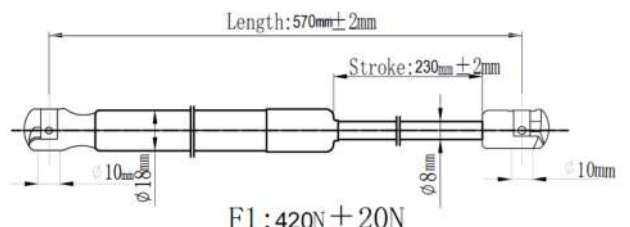

F1 : 420N ± 20N

| | | |
|------------|----------|----------|
| Japanparts | Ashika | Japko |
| ZS05000 | ZSA05000 | ZSJ05000 |

O. E. M.: 2028800029

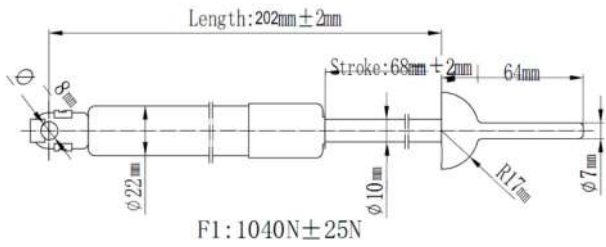

| | | |
|------------|----------|----------|
| Japanparts | Ashika | Japko |
| ZS05001 | ZSA05001 | ZSJ05001 |

O. E. M.: 2108800429

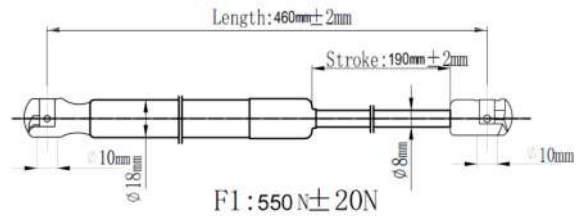

| | | |
|------------|----------|----------|
| Japanparts | Ashika | Japko |
| ZS05002 | ZSA05002 | ZSJ05002 |

O. E. M.: 4149800064

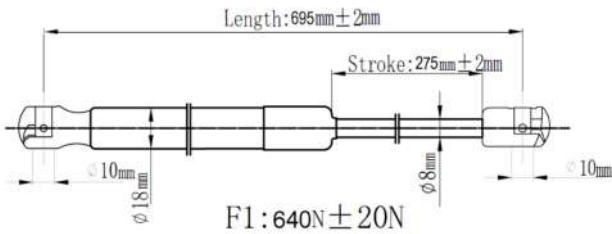

| | | |
|------------|----------|----------|
| Japanparts | Ashika | Japko |
| ZS05003 | ZSA05003 | ZSJ05003 |

O. E. M.: 2208800329

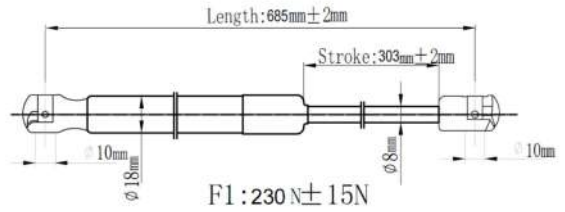

| | | |
|------------|----------|----------|
| Japanparts | Ashika | Japko |
| ZS05004 | ZSA05004 | ZSJ05004 |

O. E. M.: 1689800164

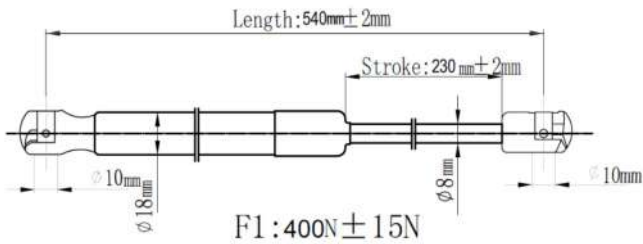

| | | |
|------------|----------|----------|
| Japanparts | Ashika | Japko |
| ZS05005 | ZSA05005 | ZSJ05005 |

O. E. M.: 2038800029

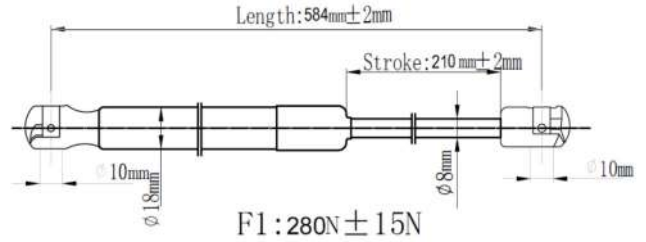

| | | |
|------------|----------|----------|
| Japanparts | Ashika | Japko |
| ZS05006 | ZSA05006 | ZSJ05006 |

O. E. M.: 2037400045

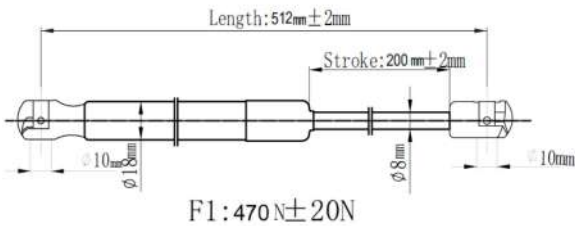

| | | |
|------------|----------|----------|
| Japanparts | Ashika | Japko |
| ZS05007 | ZSA05007 | ZSJ05007 |

O. E. M.: 2088800029

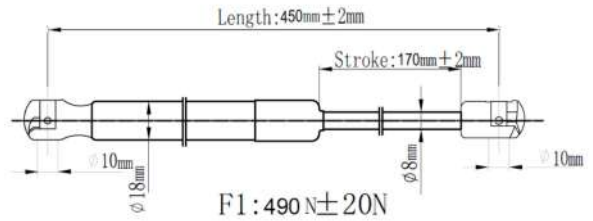

| | | |
|------------|----------|----------|
| Japanparts | Ashika | Japko |
| ZS05008 | ZSA05008 | ZSJ05008 |

O. E. M.: 2118800029

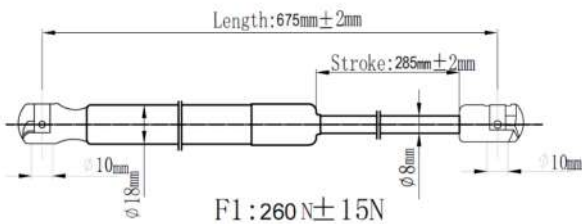

| | | |
|------------|----------|----------|
| Japanparts | Ashika | Japko |
| ZS05009 | ZSA05009 | ZSJ05009 |

O. E. M.: 1638800029

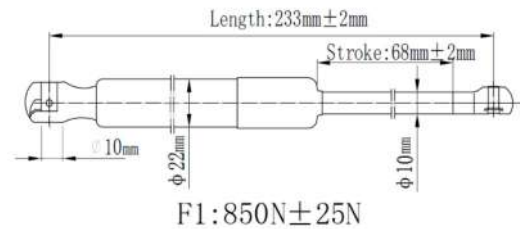

| | | |
|------------|----------|----------|
| Japanparts | Ashika | Japko |
| ZS05010 | ZSA05010 | ZSJ05010 |

O. E. M.: 1637400045

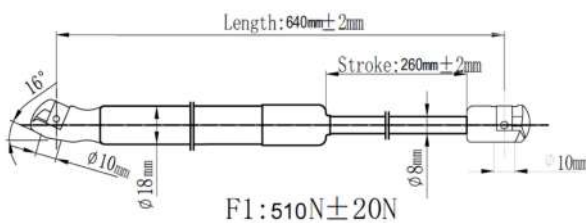

| | | |
|------------|----------|----------|
| Japanparts | Ashika | Japko |
| ZS05011 | ZSA05011 | ZSJ05011 |

O. E. M.: 1249800164

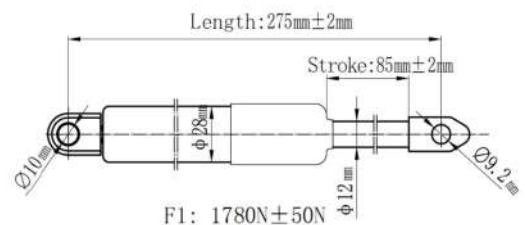

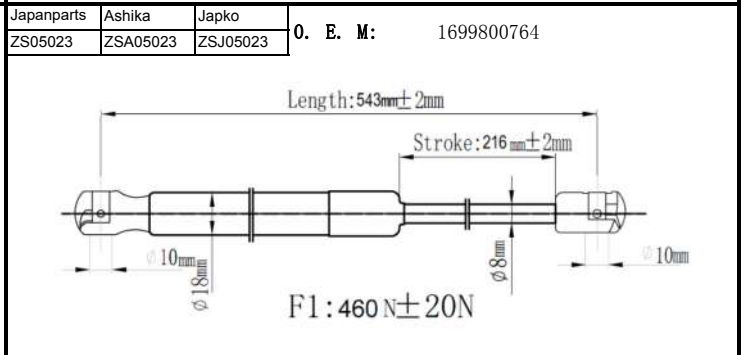
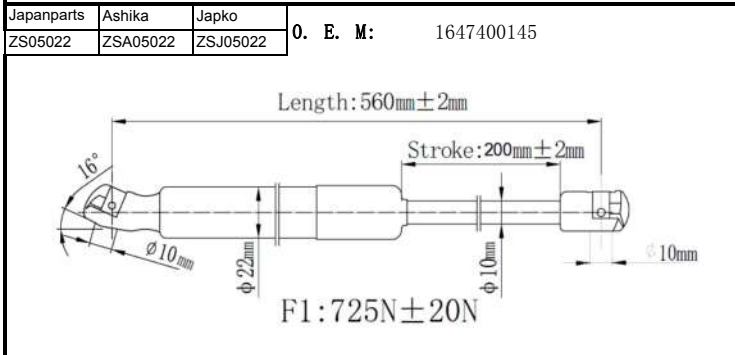
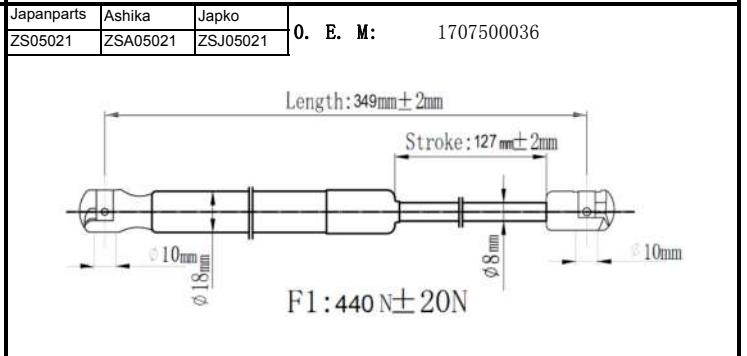
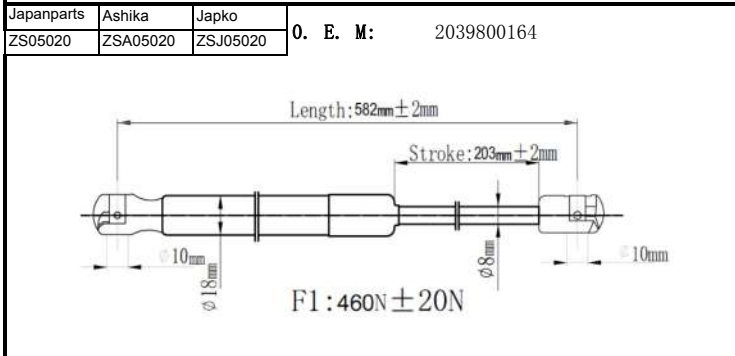
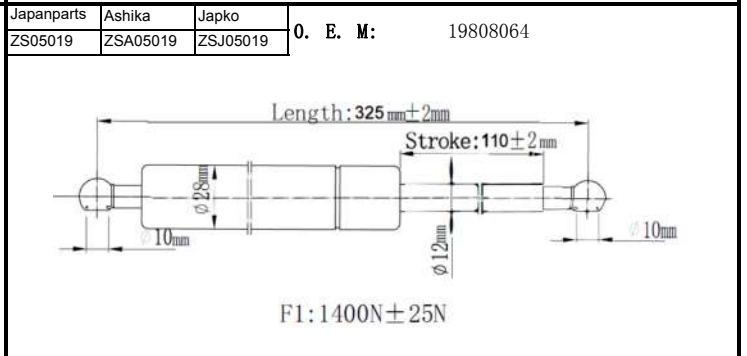
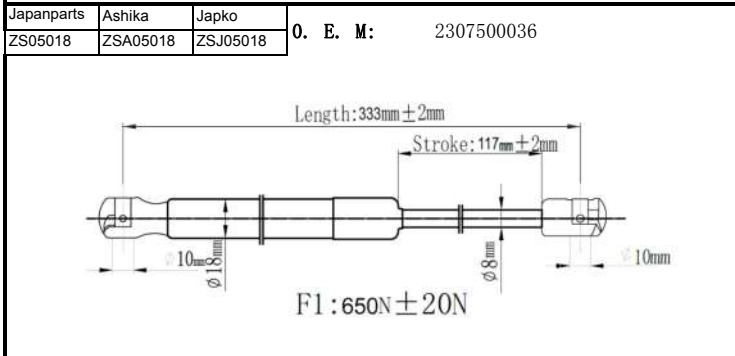
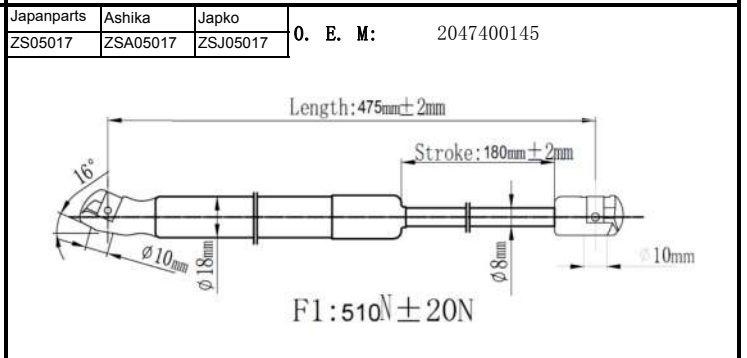
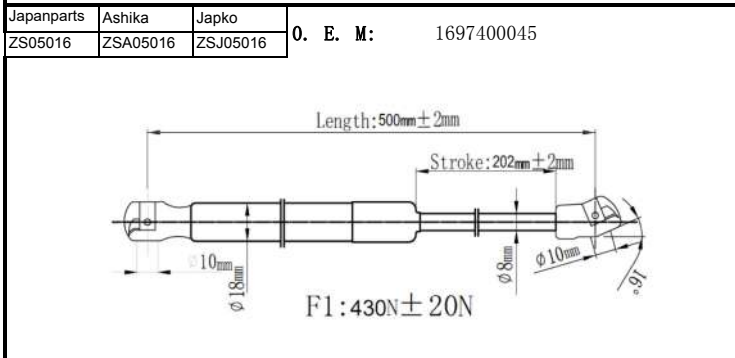
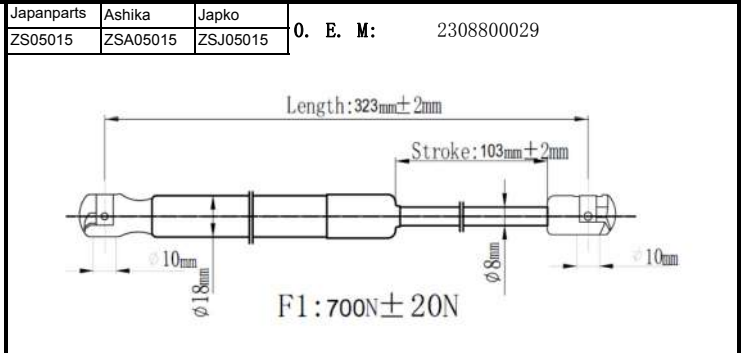
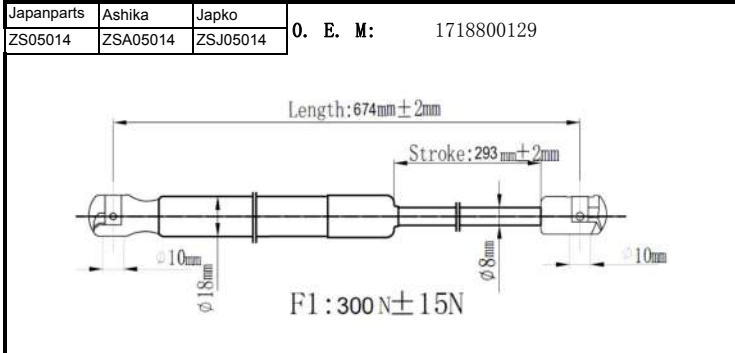
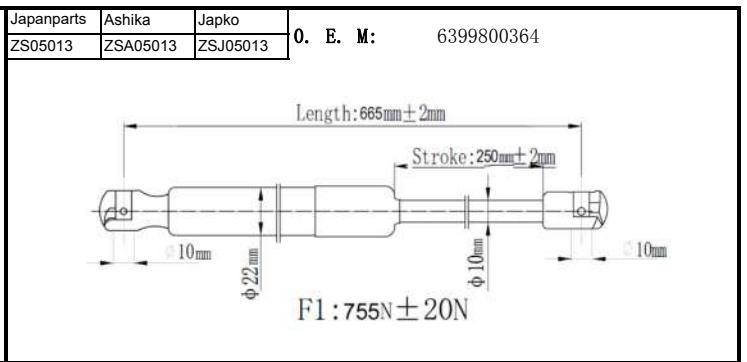
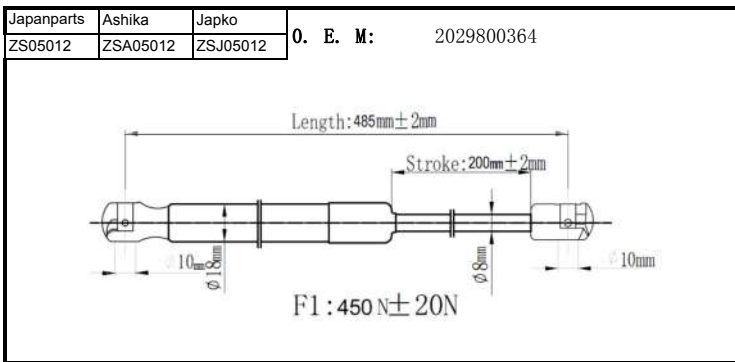

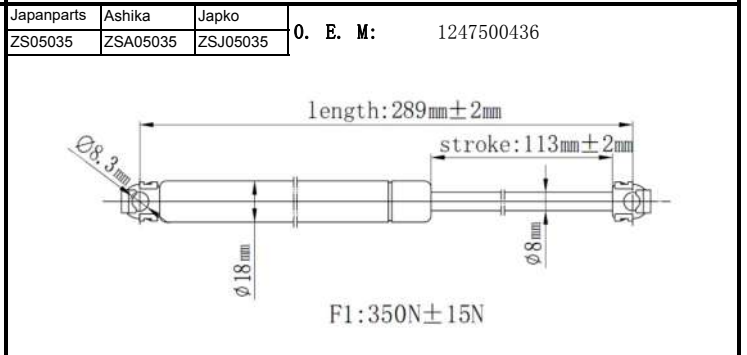
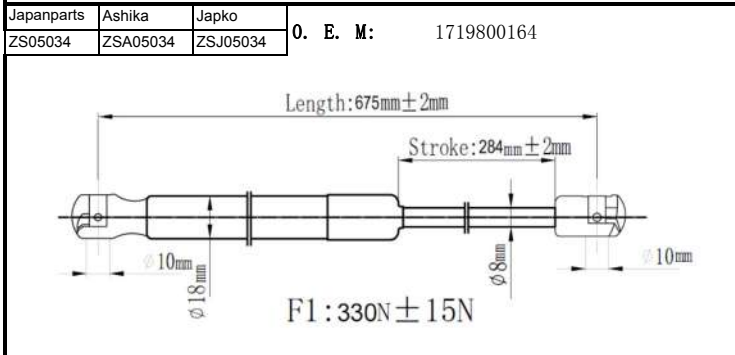
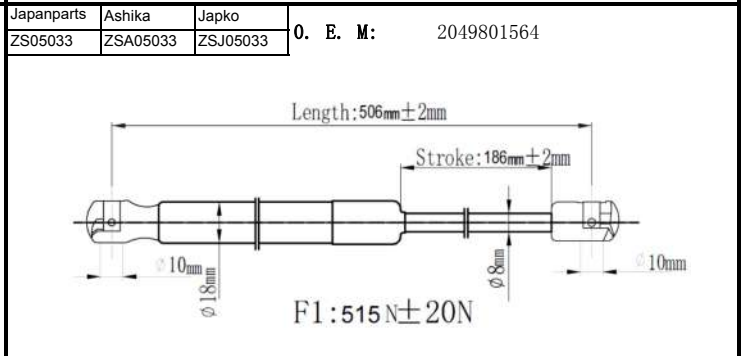
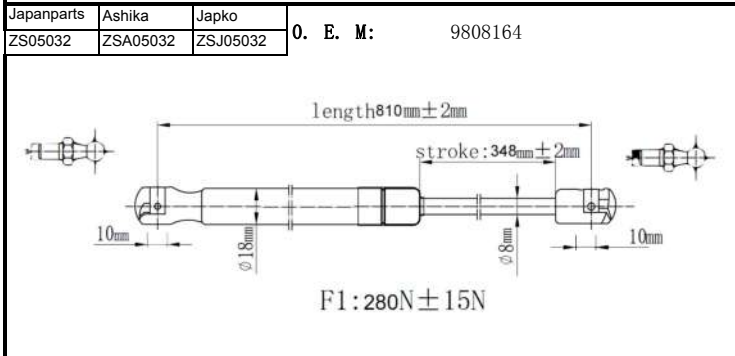
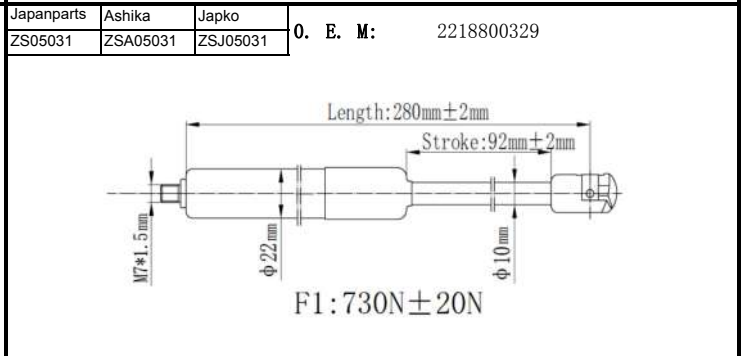
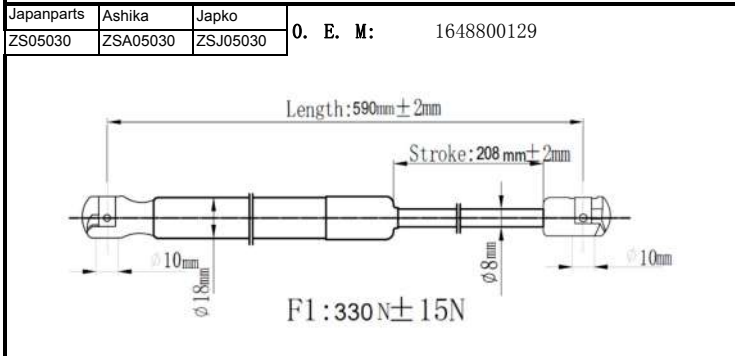
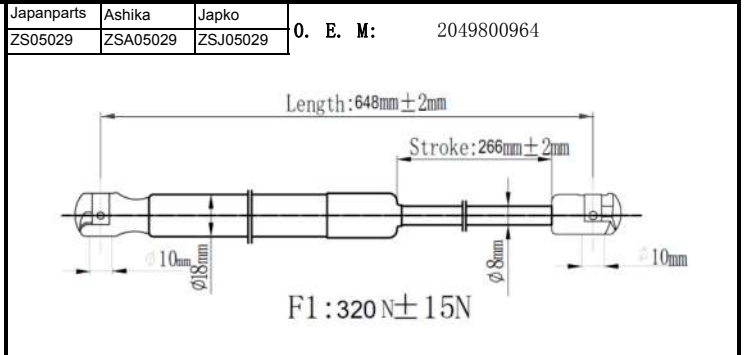
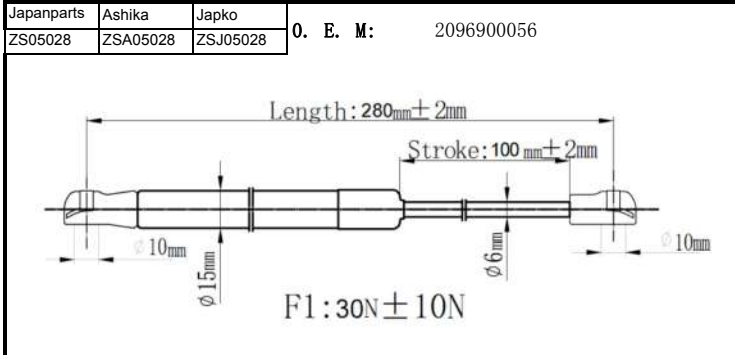
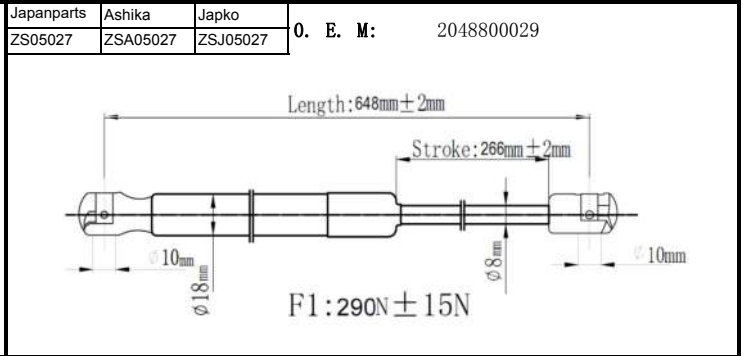
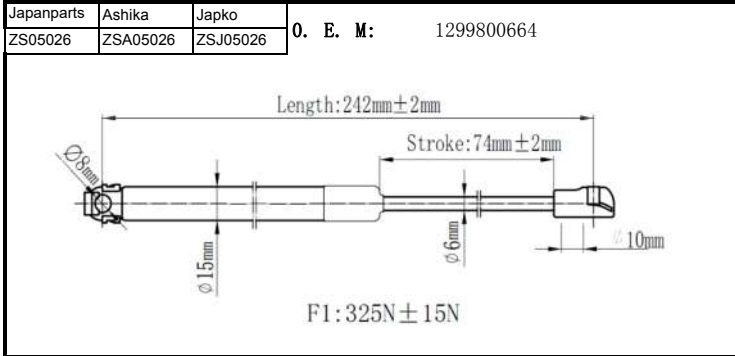
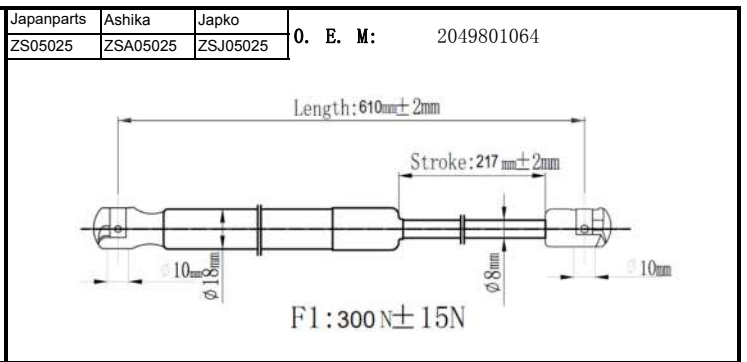
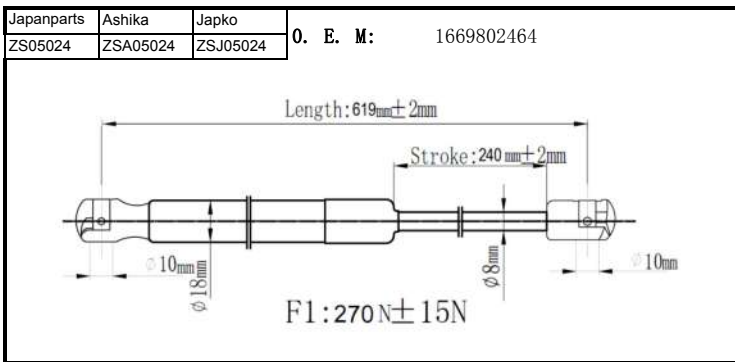

| | | |
|------------|----------|----------|
| Japanparts | Ashika | Japko |
| ZS05036 | ZSA05036 | ZSJ05036 |

O. E. M.: 2039800764

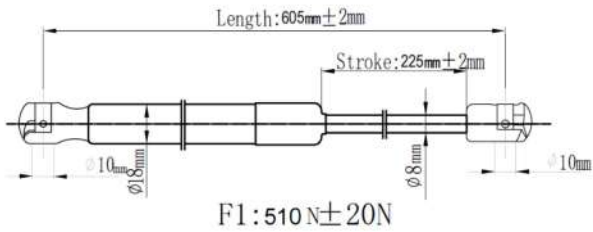

| | | |
|------------|----------|----------|
| Japanparts | Ashika | Japko |
| ZS05037 | ZSA05037 | ZSJ05037 |

O. E. M.: 2049801164

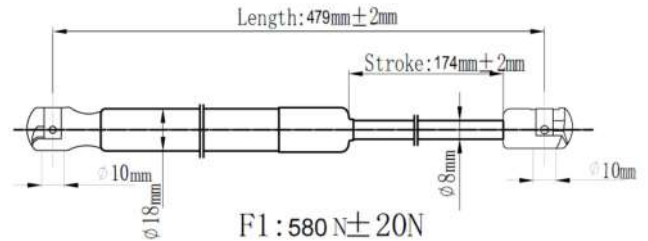

| | | |
|------------|----------|----------|
| Japanparts | Ashika | Japko |
| ZS05038 | ZSA05038 | ZSJ05038 |

O. E. M.: 2087500036

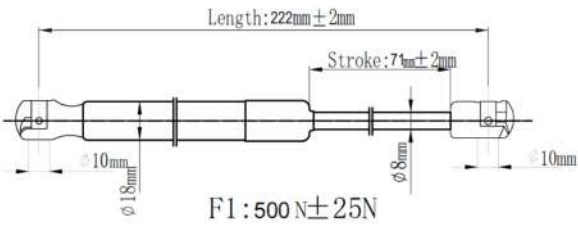

| | | |
|------------|----------|----------|
| Japanparts | Ashika | Japko |
| ZS05039 | ZSA05039 | ZSJ05039 |

O. E. M.: 2309800164

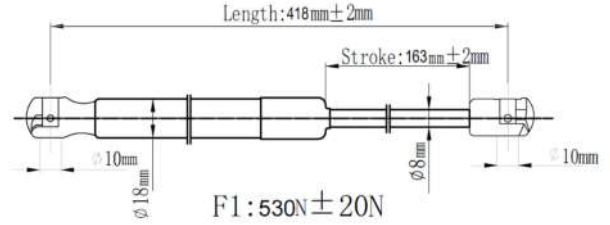

| | | |
|------------|----------|----------|
| Japanparts | Ashika | Japko |
| ZS05040 | ZSA05040 | ZSJ05040 |

O. E. M.: A2049800764

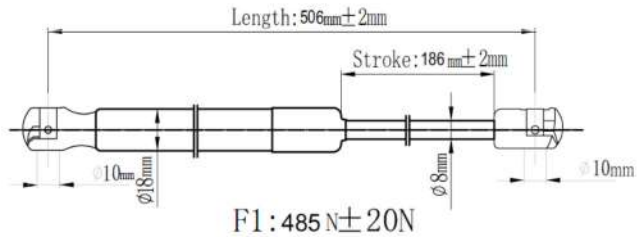

| | | |
|------------|----------|----------|
| Japanparts | Ashika | Japko |
| ZS05041 | ZSA05041 | ZSJ05041 |

O. E. M.: A2099800364

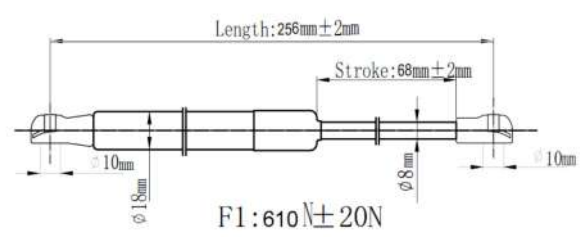

| | | |
|------------|----------|----------|
| Japanparts | Ashika | Japko |
| ZS05042 | ZSA05042 | ZSJ05042 |

O. E. M.: 2469800164

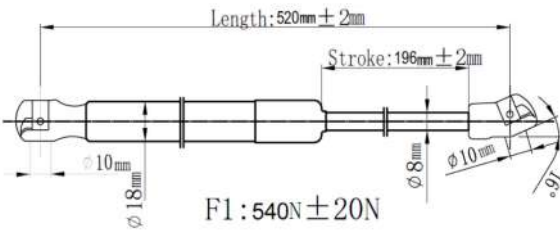

| | | |
|------------|----------|----------|
| Japanparts | Ashika | Japko |
| ZS05043 | ZSA05043 | ZSJ05043 |

O. E. M.: 1769800164

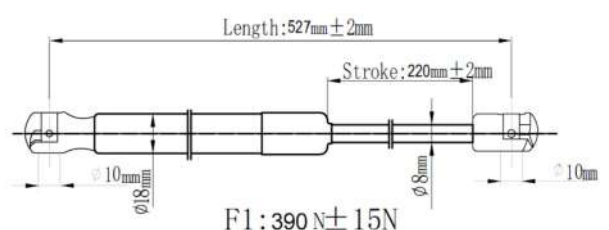

| | | |
|------------|----------|----------|
| Japanparts | Ashika | Japko |
| ZS05044 | ZSA05044 | ZSJ05044 |

O. E. M.: 2158800029

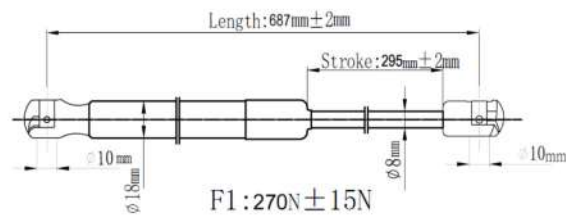

| | | |
|------------|----------|----------|
| Japanparts | Ashika | Japko |
| ZS05045 | ZSA05045 | ZSJ05045 |

O. E. M.: 2099800064

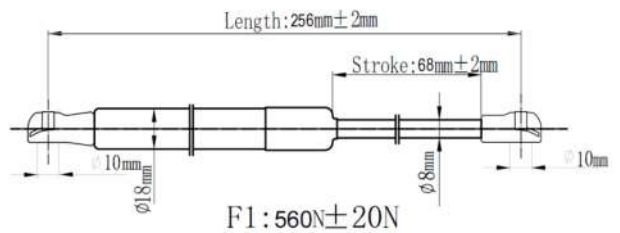

| | | |
|------------|----------|----------|
| Japanparts | Ashika | Japko |
| ZS05046 | ZSA05046 | ZSJ05046 |

O. E. M.: 1717500036

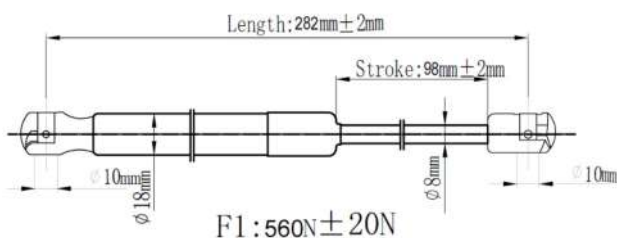

| | | |
|------------|----------|----------|
| Japanparts | Ashika | Japko |
| ZS05047 | ZSA05047 | ZSJ05047 |

O. E. M.: 2517400045

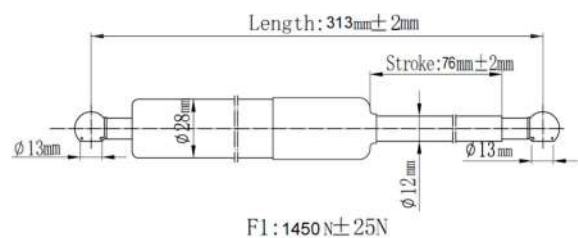

| | | |
|------------|----------|----------|
| Japanparts | Ashika | Japko |
| ZS05048 | ZSA05048 | ZSJ05048 |

O. E. M.: 6389800364

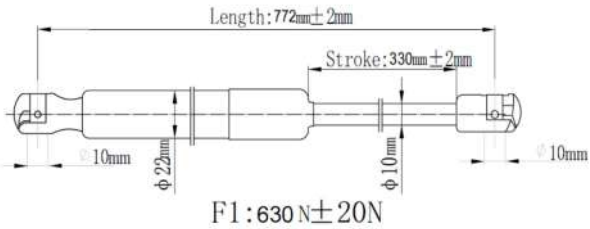

| | | |
|------------|----------|----------|
| Japanparts | Ashika | Japko |
| ZS05049 | ZSA05049 | ZSJ05049 |

O. E. M.: 2119800364

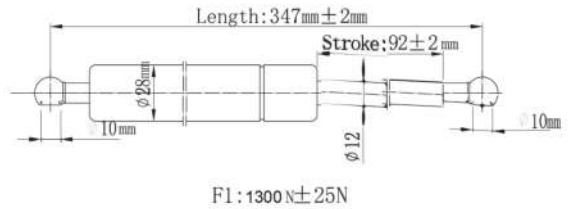

| | | |
|------------|----------|----------|
| Japanparts | Ashika | Japko |
| ZS05050 | ZSA05050 | ZSJ05050 |

O. E. M.: 2309800264

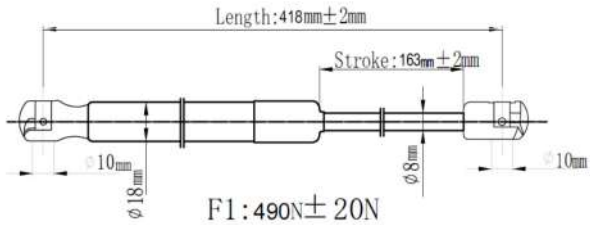

| | | |
|------------|----------|----------|
| Japanparts | Ashika | Japko |
| ZS05051 | ZSA05051 | ZSJ05051 |

O. E. M.: 1299800664

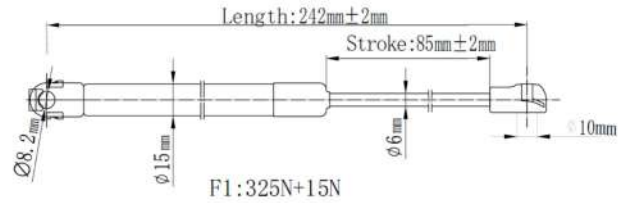

| | | |
|------------|----------|----------|
| Japanparts | Ashika | Japko |
| ZS05052 | ZSA05052 | ZSJ05052 |

O. E. M.: 1729800264

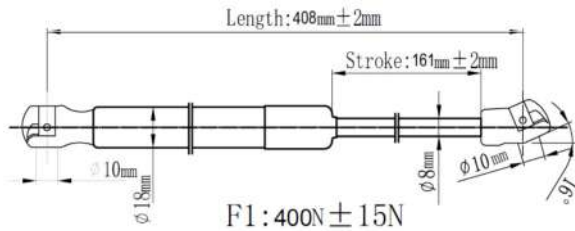

| | | |
|------------|----------|----------|
| Japanparts | Ashika | Japko |
| ZS05053 | ZSA05053 | ZSJ05053 |

O. E. M.: 1649800364

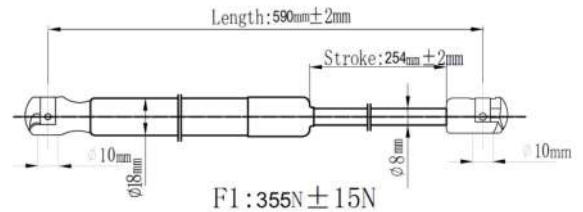

| | | |
|------------|----------|----------|
| Japanparts | Ashika | Japko |
| ZS05054 | ZSA05054 | ZSJ05054 |

O. E. M.: 2217500216

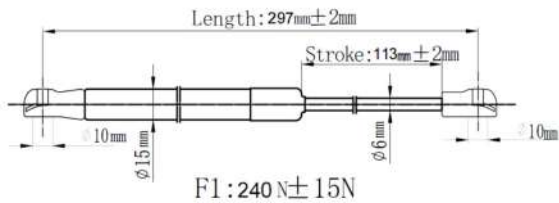

| | | |
|------------|----------|----------|
| Japanparts | Ashika | Japko |
| ZS05056 | ZSA05056 | ZSJ05056 |

O. E. M.: A1569800764

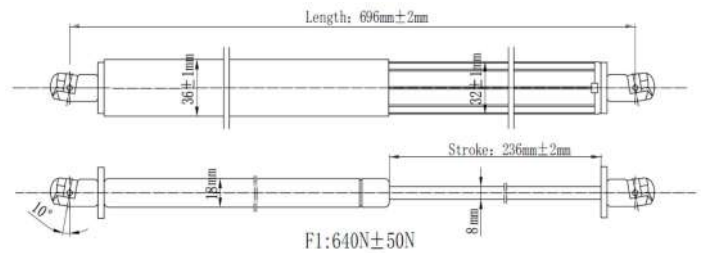

| | | |
|------------|----------|----------|
| Japanparts | Ashika | Japko |
| ZS06000 | ZSA06000 | ZSJ06000 |

O. E. M.: 792514

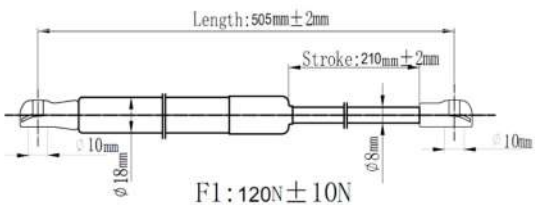

| | | |
|------------|----------|----------|
| Japanparts | Ashika | Japko |
| ZS06001 | ZSA06001 | ZSJ06001 |

O. E. M.: 8731C2

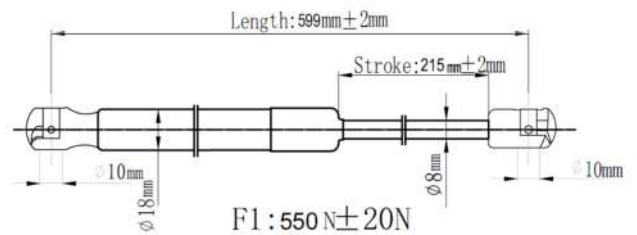

| | | |
|------------|----------|----------|
| Japanparts | Ashika | Japko |
| ZS06002 | ZSA06002 | ZSJ06002 |

O. E. M.: 87310000

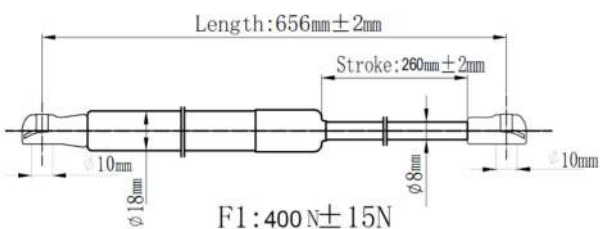

| | | |
|------------|----------|----------|
| Japanparts | Ashika | Japko |
| ZS06003 | ZSA06003 | ZSJ06003 |

O. E. M.: 8731P0

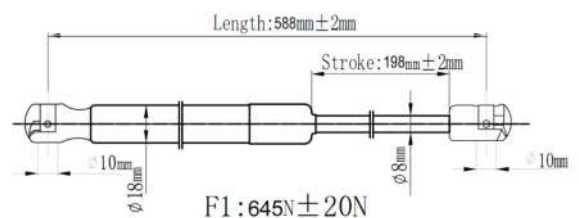

| | | |
|------------|----------|----------|
| Japanparts | Ashika | Japko |
| ZS06004 | ZSA06004 | ZSJ06004 |

O. E. M.: 8731J8

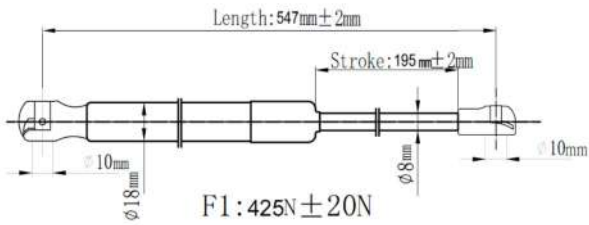

| | | |
|------------|----------|----------|
| Japanparts | Ashika | Japko |
| ZS06005 | ZSA06005 | ZSJ06005 |

O. E. M.: 8731N8

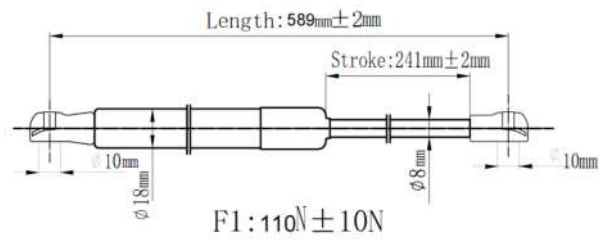

| | | |
|------------|----------|----------|
| Japanparts | Ashika | Japko |
| ZS06006 | ZSA06006 | ZSJ06006 |

O. E. M.: 792520

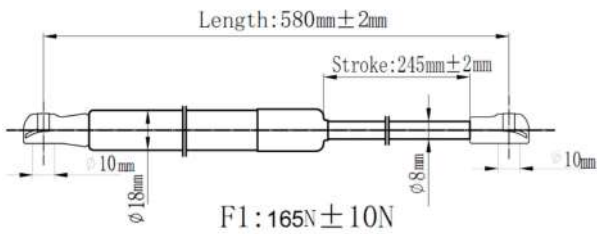

| | | |
|------------|----------|----------|
| Japanparts | Ashika | Japko |
| ZS06007 | ZSA06007 | ZSJ06007 |

O. E. M.: 8731K8

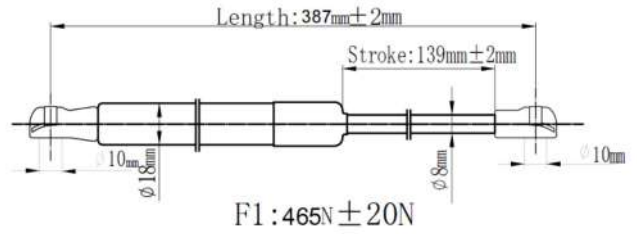

| | | |
|------------|----------|----------|
| Japanparts | Ashika | Japko |
| ZS06008 | ZSA06008 | ZSJ06008 |

O. E. M.: 10004215A

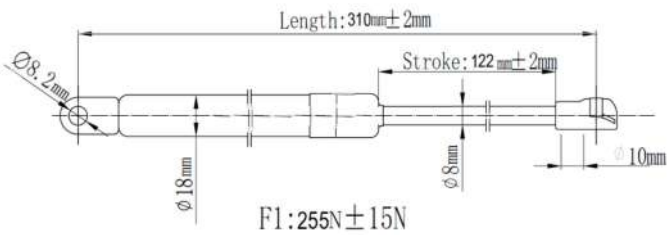

| | | |
|------------|----------|----------|
| Japanparts | Ashika | Japko |
| ZS06009 | ZSA06009 | ZSJ06009 |

O. E. M.: 8731R6

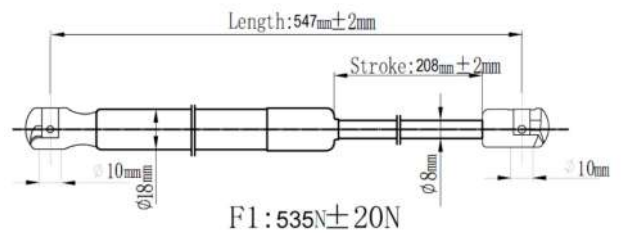

| | | |
|------------|----------|----------|
| Japanparts | Ashika | Japko |
| ZS06010 | ZSA06010 | ZSJ06010 |

O. E. M.: 7000510368C0

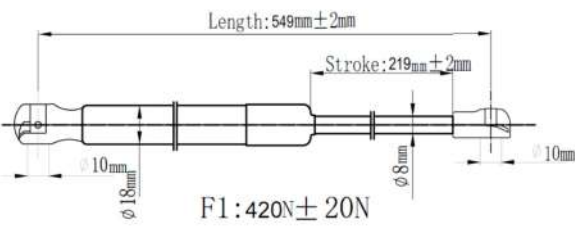

| | | |
|------------|----------|----------|
| Japanparts | Ashika | Japko |
| ZS06011 | ZSA06011 | ZSJ06011 |

O. E. M.: 782511

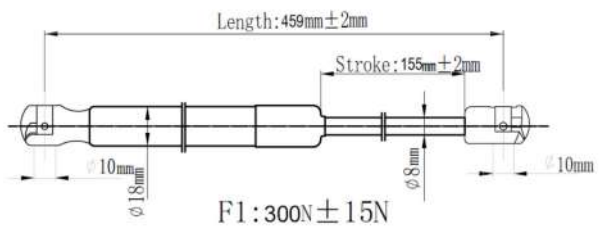

| | | |
|------------|----------|----------|
| Japanparts | Ashika | Japko |
| ZS06012 | ZSA06012 | ZSJ06012 |

O. E. M.: 8731K1

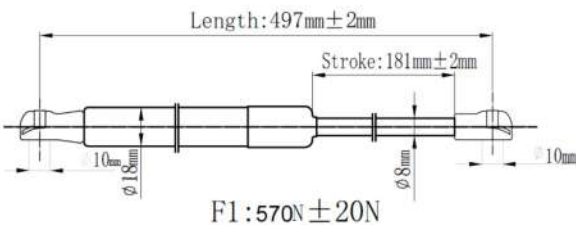

| | | |
|------------|----------|----------|
| Japanparts | Ashika | Japko |
| ZS06013 | ZSA06013 | ZSJ06013 |

O. E. M.: 8731C3

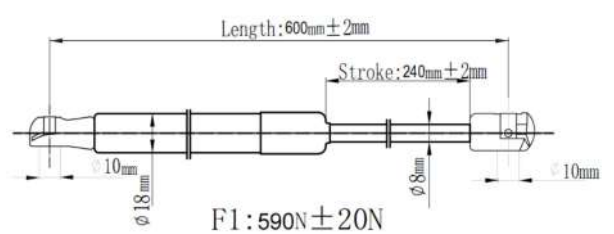

| | | |
|------------|----------|----------|
| Japanparts | Ashika | Japko |
| ZS06014 | ZSA06014 | ZSJ06014 |

O. E. M.: 8731N9

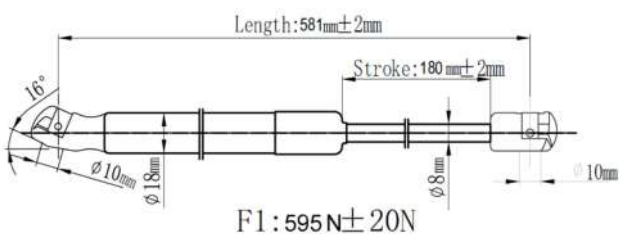

| | | |
|------------|----------|----------|
| Japanparts | Ashika | Japko |
| ZS06015 | ZSA06015 | ZSJ06015 |

O. E. M.: 8731P2

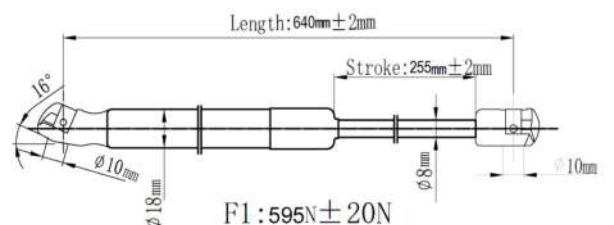

| | | |
|------------|----------|----------|
| Japanparts | Ashika | Japko |
| ZS06016 | ZSA06016 | ZSJ06016 |

O. E. M: 8731L9

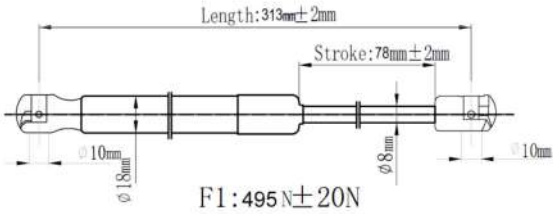

| | | |
|------------|----------|----------|
| Japanparts | Ashika | Japko |
| ZS06017 | ZSA06017 | ZSJ06017 |

O. E. M: 96095456

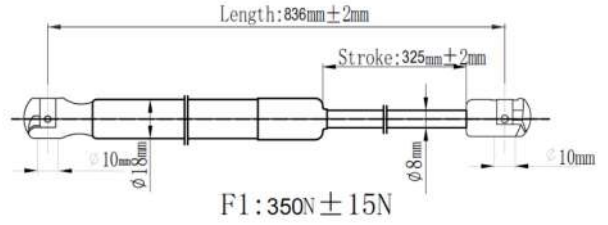

| | | |
|------------|----------|----------|
| Japanparts | Ashika | Japko |
| ZS06018 | ZSA06018 | ZSJ06018 |

O. E. M: 9686809480

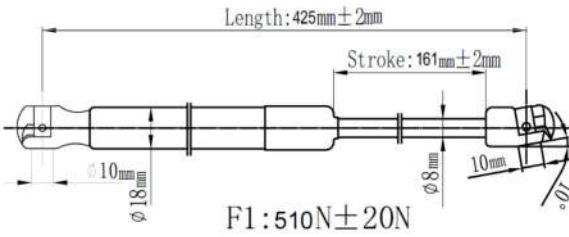

| | | |
|------------|----------|----------|
| Japanparts | Ashika | Japko |
| ZS06019 | ZSA06019 | ZSJ06019 |

O. E. M: 7000210373B0

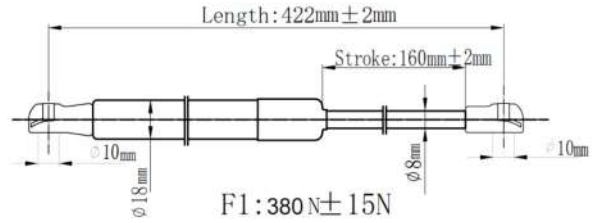

| | | |
|------------|----------|----------|
| Japanparts | Ashika | Japko |
| ZS06020 | ZSA06020 | ZSJ06020 |

O. E. M: 8731T9

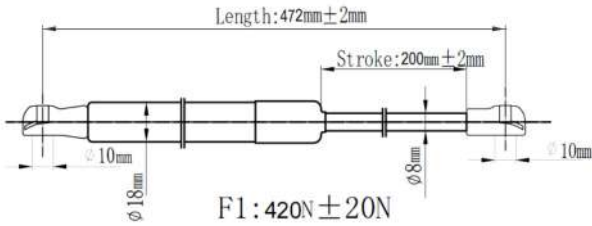

| | | |
|------------|----------|----------|
| Japanparts | Ashika | Japko |
| ZS06021 | ZSA06021 | ZSJ06021 |

O. E. M: 8731V8

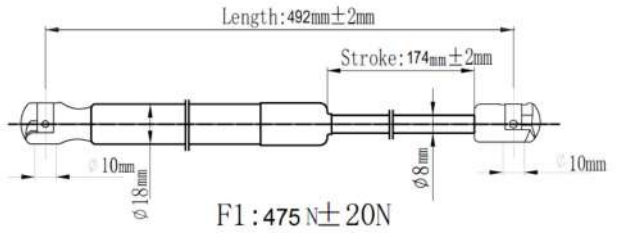

| | | |
|------------|----------|----------|
| Japanparts | Ashika | Japko |
| ZS06022 | ZSA06022 | ZSJ06022 |

O. E. M: 95639144

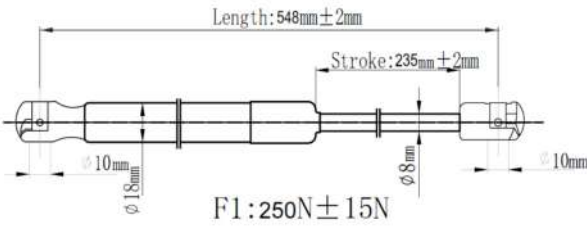

| | | |
|------------|----------|----------|
| Japanparts | Ashika | Japko |
| ZS06023 | ZSA06023 | ZSJ06023 |

O. E. M: 8731J9

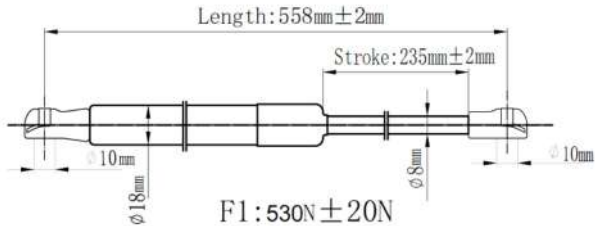

| | | |
|------------|----------|----------|
| Japanparts | Ashika | Japko |
| ZS06024 | ZSA06024 | ZSJ06024 |

O. E. M: 95496134

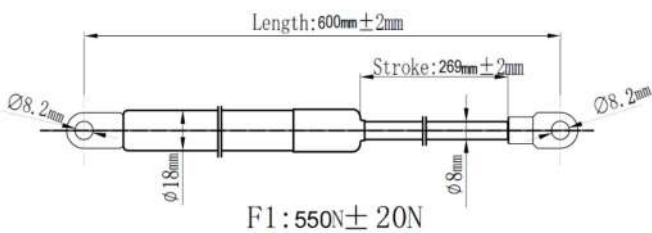

| | | |
|------------|----------|----------|
| Japanparts | Ashika | Japko |
| ZS06025 | ZSA06025 | ZSJ06025 |

O. E. M: 95635989

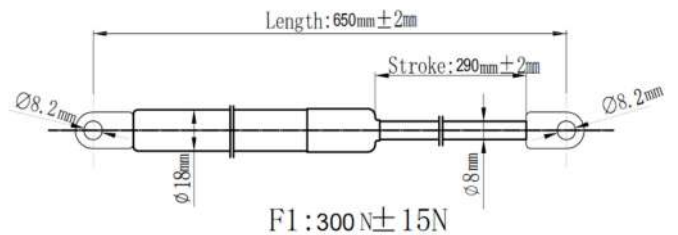

| | | |
|------------|----------|----------|
| Japanparts | Ashika | Japko |
| ZS06026 | ZSA06026 | ZSJ06026 |

O. E. M: 95568544

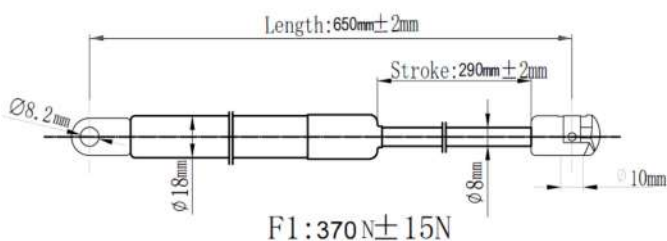

| | | |
|------------|----------|----------|
| Japanparts | Ashika | Japko |
| ZS06027 | ZSA06027 | ZSJ06027 |

O. E. M: 95606490

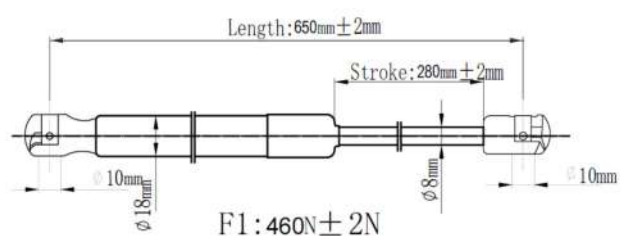

| | | |
|------------|----------|----------|
| Japanparts | Ashika | Japko |
| ZS06028 | ZSA06028 | ZSJ06028 |

O. E. M.: 8731.G3

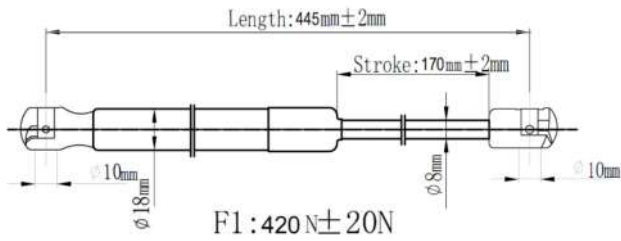

| | | |
|------------|----------|----------|
| Japanparts | Ashika | Japko |
| ZS06029 | ZSA06029 | ZSJ06029 |

O. E. M.: 95631956

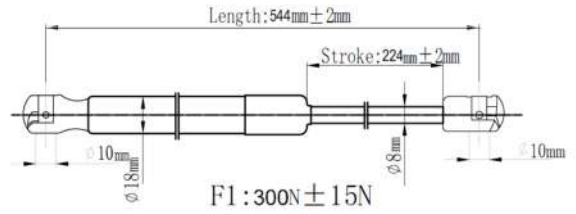

| | | |
|------------|----------|----------|
| Japanparts | Ashika | Japko |
| ZS06030 | ZSA06030 | ZSJ06030 |

O. E. M.: 8731C0

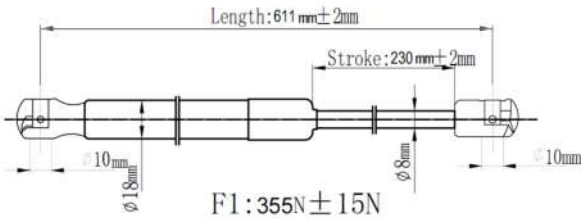

| | | |
|------------|----------|----------|
| Japanparts | Ashika | Japko |
| ZS06031 | ZSA06031 | ZSJ06031 |

O. E. M.: 8731F1

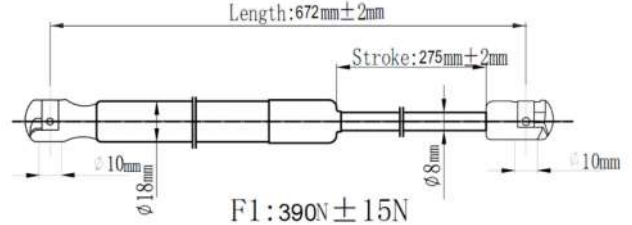

| | | |
|------------|----------|----------|
| Japanparts | Ashika | Japko |
| ZS06032 | ZSA06032 | ZSJ06032 |

O. E. M.: 8731H8

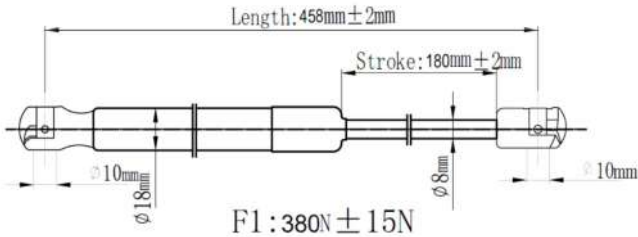

| | | |
|------------|----------|----------|
| Japanparts | Ashika | Japko |
| ZS06033 | ZSA06033 | ZSJ06033 |

O. E. M.: 87310

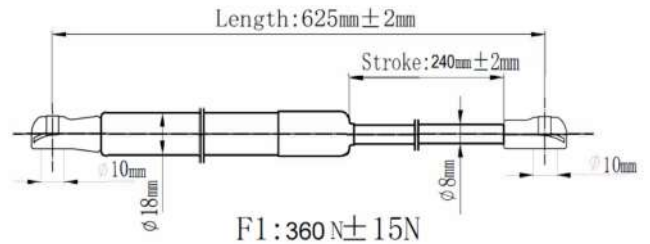

| | | |
|------------|----------|----------|
| Japanparts | Ashika | Japko |
| ZS06034 | ZSA06034 | ZSJ06034 |

O. E. M.: 8731 K0

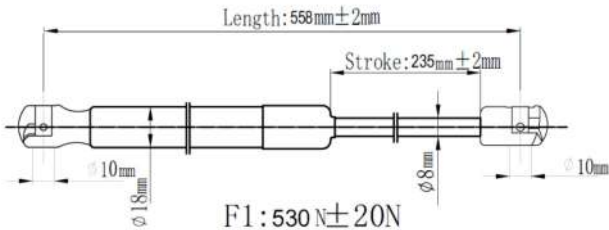

| | | |
|------------|----------|----------|
| Japanparts | Ashika | Japko |
| ZS06035 | ZSA06035 | ZSJ06035 |

O. E. M.: 8731A8

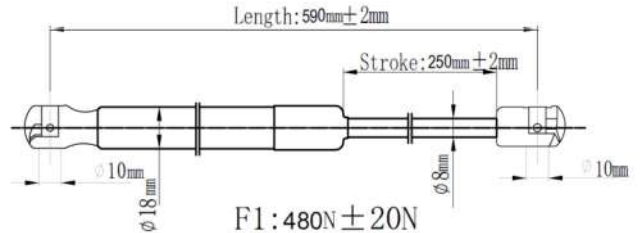

| | | |
|------------|----------|----------|
| Japanparts | Ashika | Japko |
| ZS06036 | ZSA06036 | ZSJ06036 |

O. E. M.: 95492745

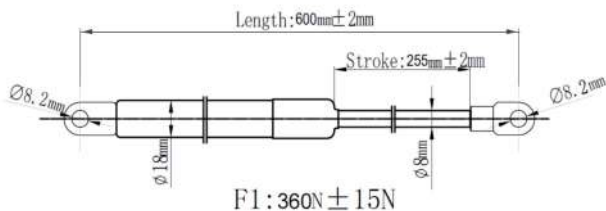

| | | |
|------------|----------|----------|
| Japanparts | Ashika | Japko |
| ZS06037 | ZSA06037 | ZSJ06037 |

O. E. M.: 96123612

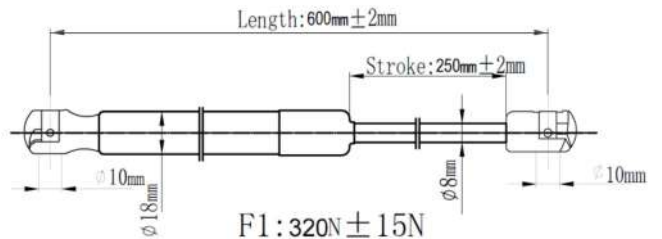

| | | |
|------------|----------|----------|
| Japanparts | Ashika | Japko |
| ZS06038 | ZSA06038 | ZSJ06038 |

O. E. M.: 96026964

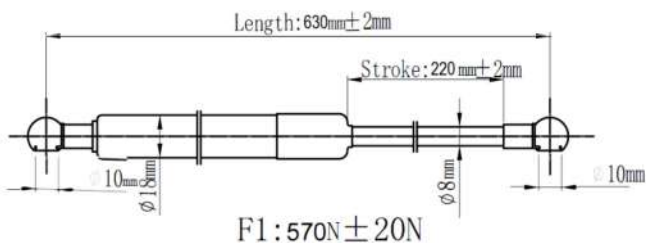

| | | |
|------------|----------|----------|
| Japanparts | Ashika | Japko |
| ZS06039 | ZSA06039 | ZSJ06039 |

O. E. M.: 96122122

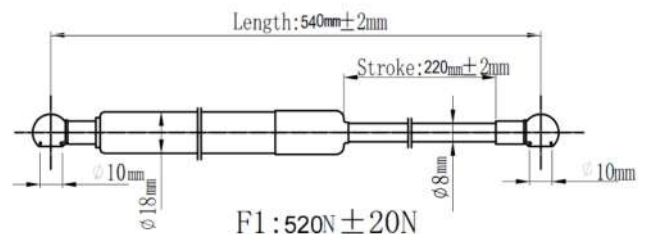

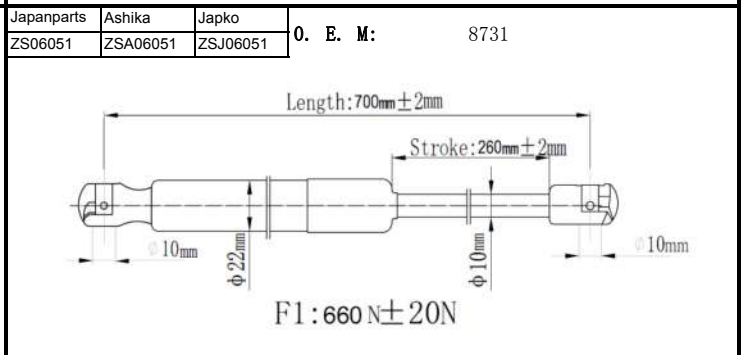
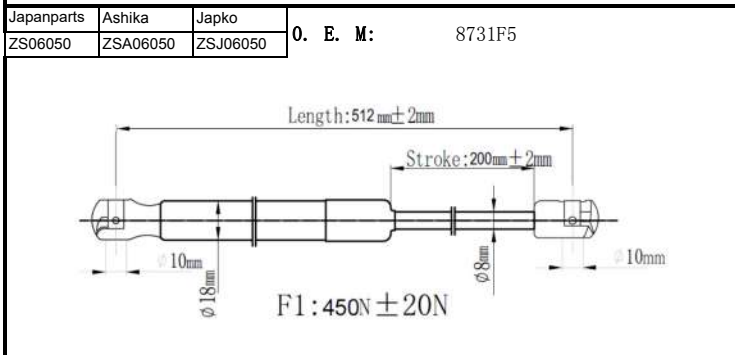
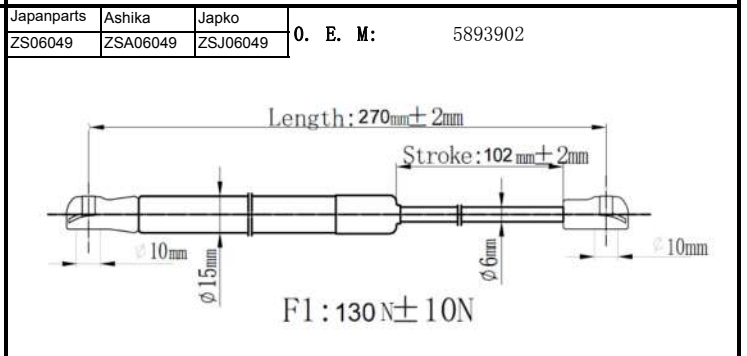
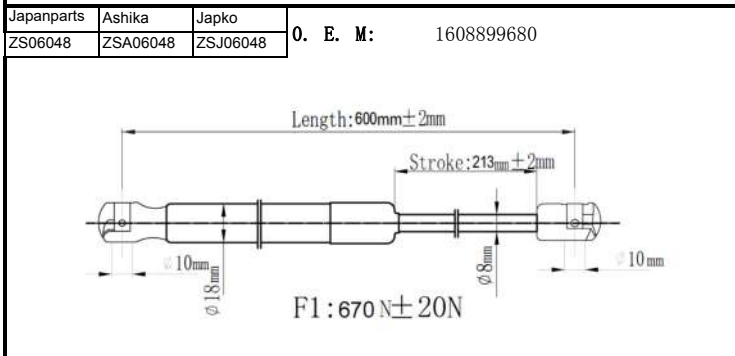
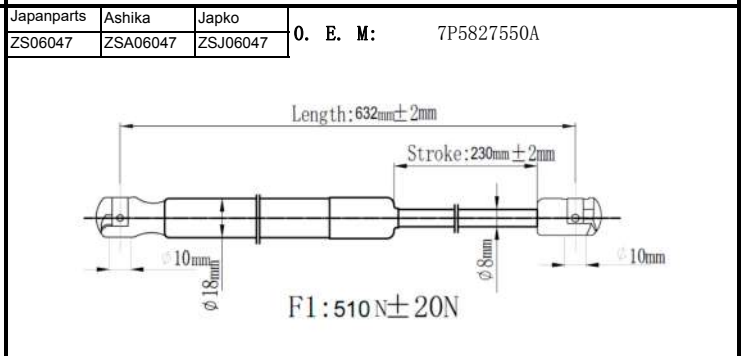
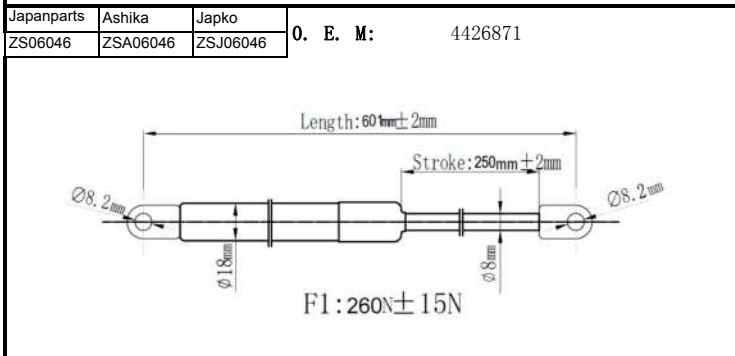
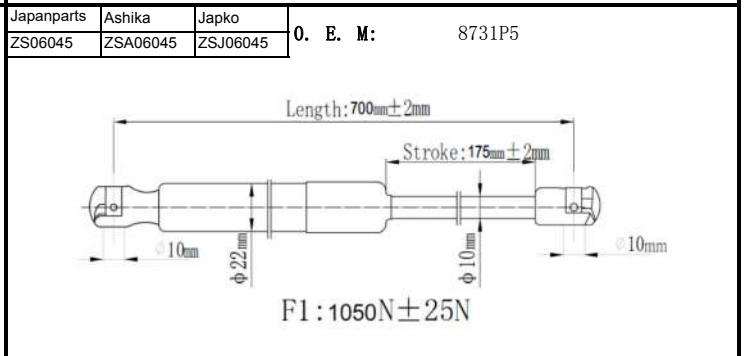
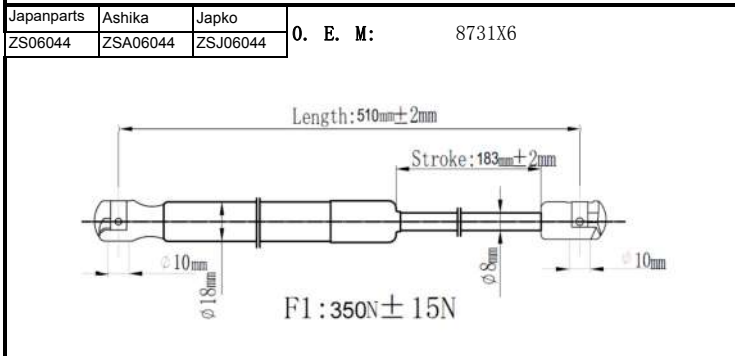
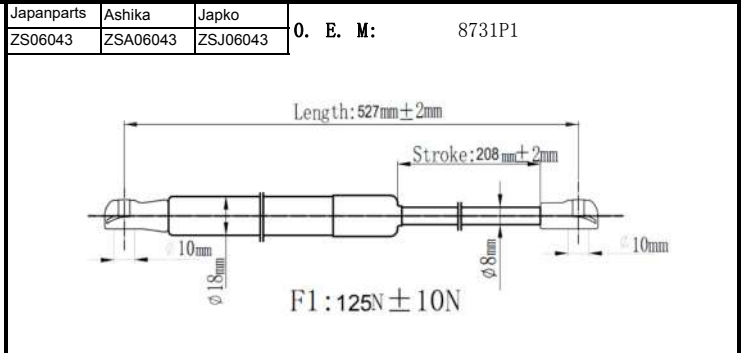
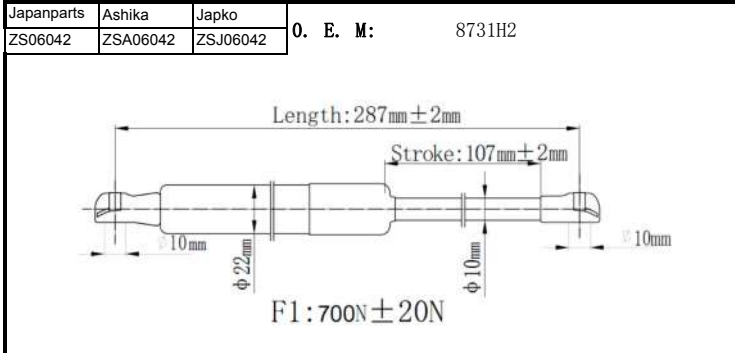
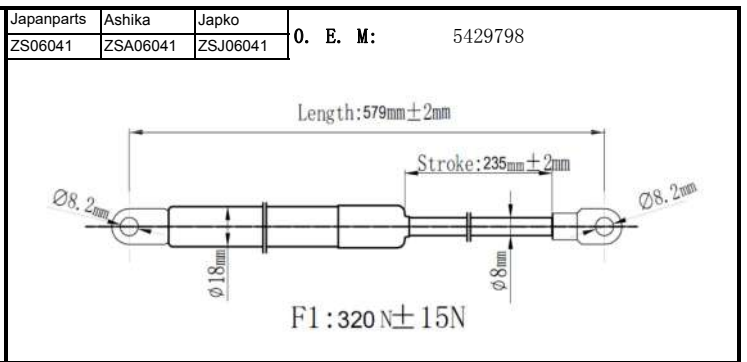
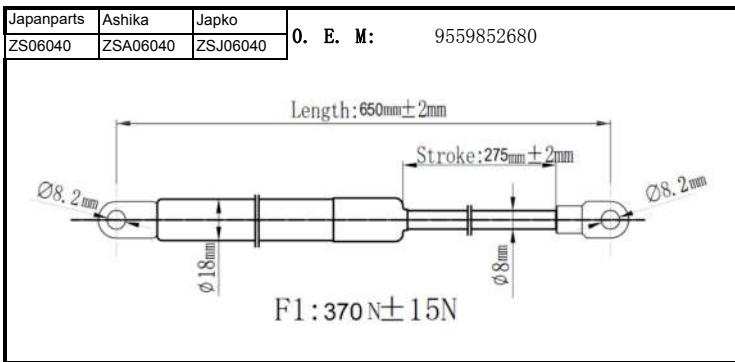

| | | |
|------------|----------|----------|
| Japanparts | Ashika | Japko |
| ZS06052 | ZSA06052 | ZSJ06052 |

O. E. M.: 8731A3

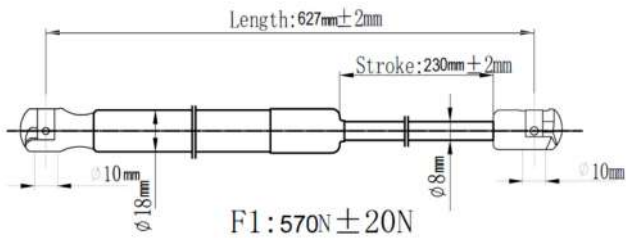

| | | |
|------------|----------|----------|
| Japanparts | Ashika | Japko |
| ZS06053 | ZSA06053 | ZSJ06053 |

O. E. M.: 8731R9

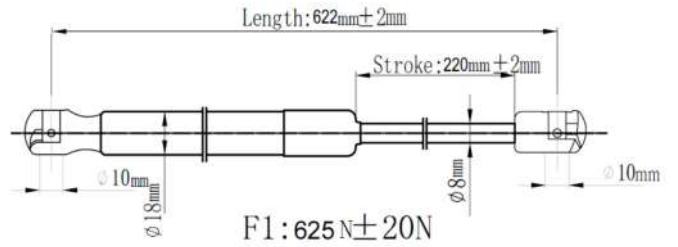

| | | |
|------------|----------|----------|
| Japanparts | Ashika | Japko |
| ZS06054 | ZSA06054 | ZSJ06054 |

O. E. M.: 8731T2

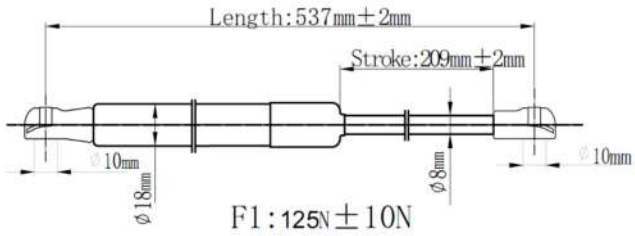

| | | |
|------------|----------|----------|
| Japanparts | Ashika | Japko |
| ZS06055 | ZSA06055 | ZSJ06055 |

O. E. M.: 1615081180

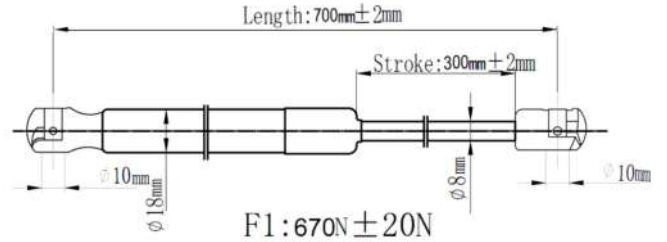

| | | |
|------------|----------|----------|
| Japanparts | Ashika | Japko |
| ZS06056 | ZSA06056 | ZSJ06056 |

O. E. M.: 689500H020

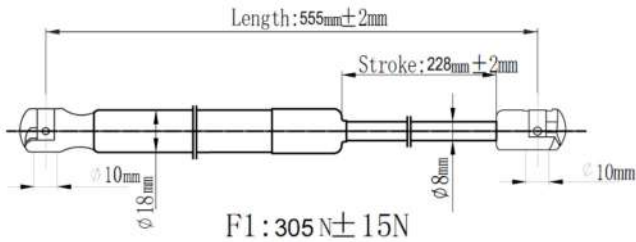

| | | |
|------------|----------|----------|
| Japanparts | Ashika | Japko |
| ZS06057 | ZSA06057 | ZSJ06057 |

O. E. M.: 792513

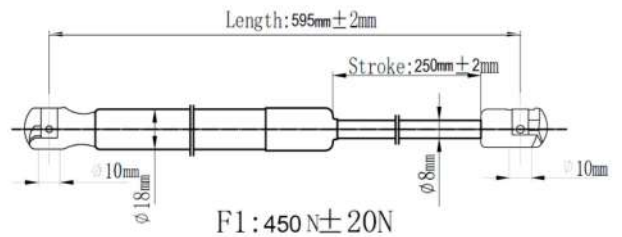

| | | |
|------------|----------|----------|
| Japanparts | Ashika | Japko |
| ZS06058 | ZSA06058 | ZSJ06058 |

O. E. M.: 75521825

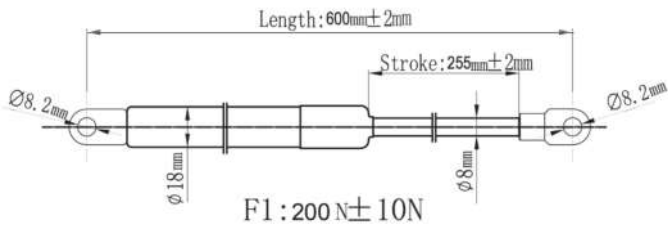

| | | |
|------------|----------|----------|
| Japanparts | Ashika | Japko |
| ZS06059 | ZSA06059 | ZSJ06059 |

O. E. M.: 8731F2

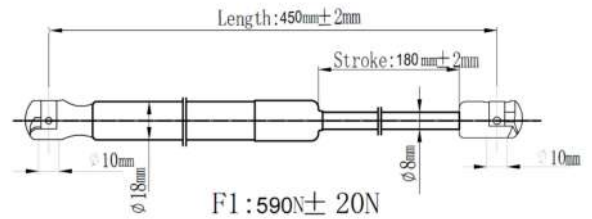

| | | |
|------------|----------|----------|
| Japanparts | Ashika | Japko |
| ZS06060 | ZSA06060 | ZSJ06060 |

O. E. M.: 51023704

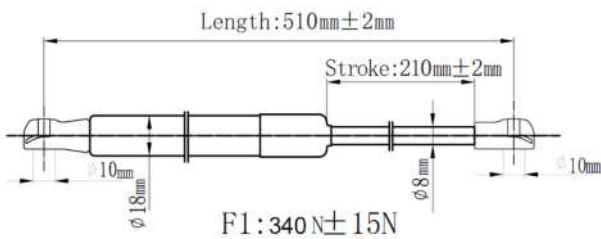

| | | |
|------------|----------|----------|
| Japanparts | Ashika | Japko |
| ZS06061 | ZSA06061 | ZSJ06061 |

O. E. M.: 873193

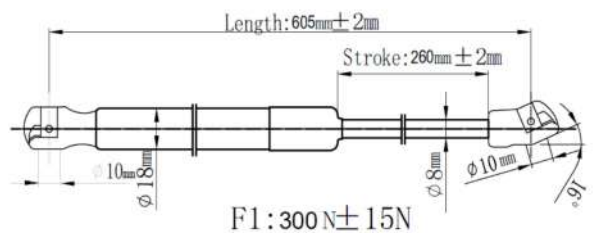

| | | |
|------------|----------|----------|
| Japanparts | Ashika | Japko |
| ZS06062 | ZSA06062 | ZSJ06062 |

O. E. M.: 8731F8

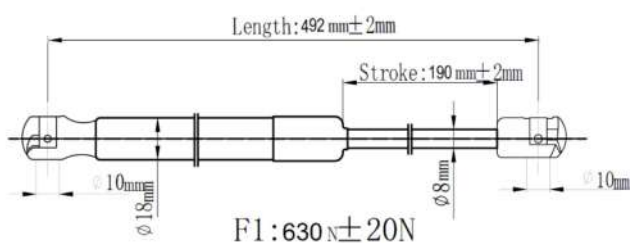

| | | |
|------------|----------|----------|
| Japanparts | Ashika | Japko |
| ZS06063 | ZSA06063 | ZSJ06063 |

O. E. M.: 8731C5

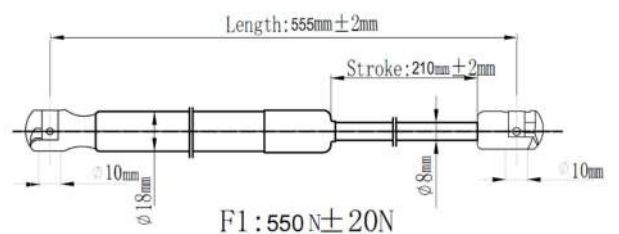

| | | |
|------------|----------|----------|
| Japanparts | Ashika | Japko |
| ZS06064 | ZSA06064 | ZSJ06064 |

O. E. M.: 792515

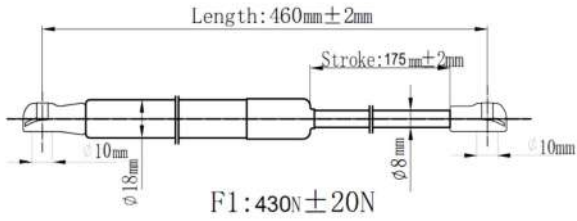

| | | |
|------------|----------|----------|
| Japanparts | Ashika | Japko |
| ZS06065 | ZSA06065 | ZSJ06065 |

O. E. M.: 7920071833

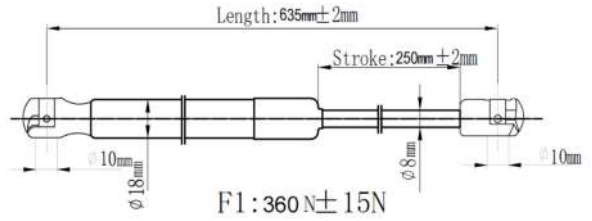

| | | |
|------------|----------|----------|
| Japanparts | Ashika | Japko |
| ZS06066 | ZSA06066 | ZSJ06066 |

O. E. M.: 8731A2

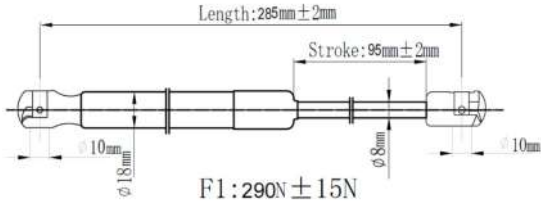

| | | |
|------------|----------|----------|
| Japanparts | Ashika | Japko |
| ZS06067 | ZSA06067 | ZSJ06067 |

O. E. M.: 8731A7

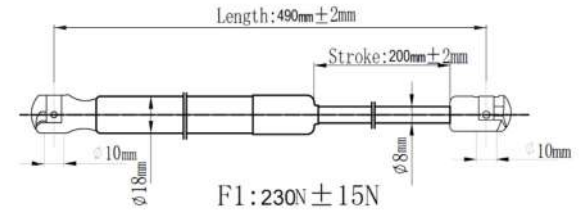

| | | |
|------------|----------|----------|
| Japanparts | Ashika | Japko |
| ZS06068 | ZSA06068 | ZSJ06068 |

O. E. M.: 8731F3

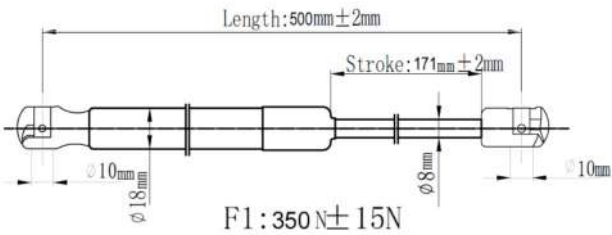

| | | |
|------------|----------|----------|
| Japanparts | Ashika | Japko |
| ZS06069 | ZSA06069 | ZSJ06069 |

O. E. M.: 8731J5

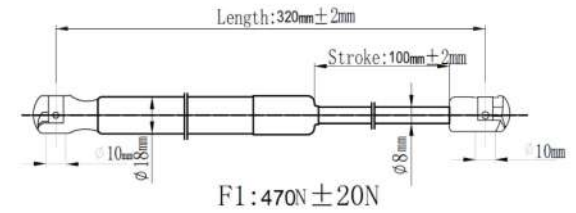

| | | |
|------------|----------|----------|
| Japanparts | Ashika | Japko |
| ZS06070 | ZSA06070 | ZSJ06070 |

O. E. M.: 2870400

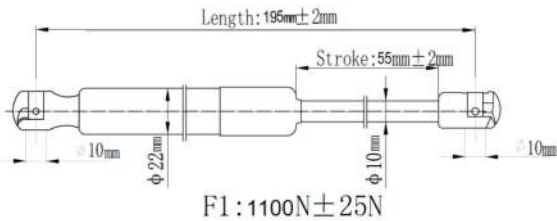

| | | |
|------------|----------|----------|
| Japanparts | Ashika | Japko |
| ZS06071 | ZSA06071 | ZSJ06071 |

O. E. M.: 8731J7

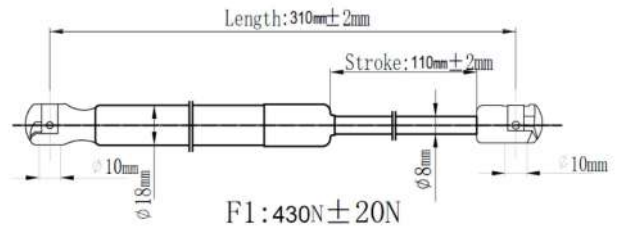

| | | |
|------------|----------|----------|
| Japanparts | Ashika | Japko |
| ZS06072 | ZSA06072 | ZSJ06072 |

O. E. M.: 8731Q6

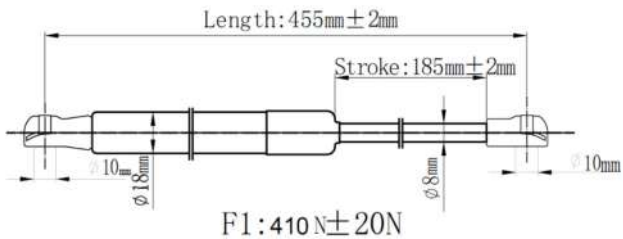

| | | |
|------------|----------|----------|
| Japanparts | Ashika | Japko |
| ZS06073 | ZSA06073 | ZSJ06073 |

O. E. M.: 792509

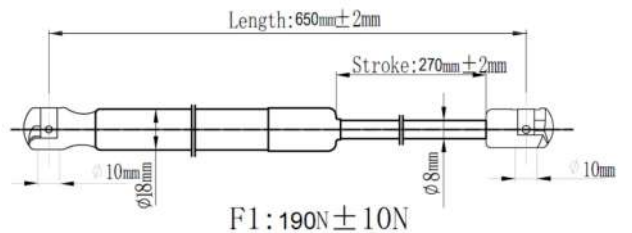

| | | |
|------------|----------|----------|
| Japanparts | Ashika | Japko |
| ZS06074 | ZSA06074 | ZSJ06074 |

O. E. M.: 873151

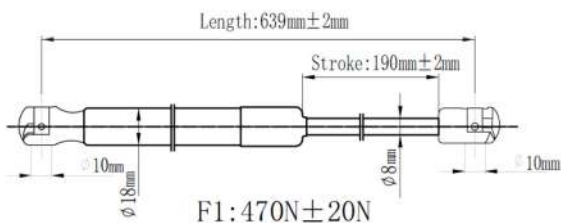

| | | |
|------------|----------|----------|
| Japanparts | Ashika | Japko |
| ZS06075 | ZSA06075 | ZSJ06075 |

O. E. M.: 873171

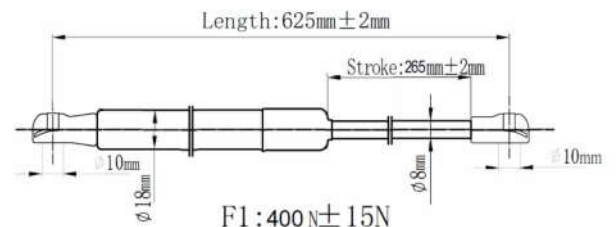

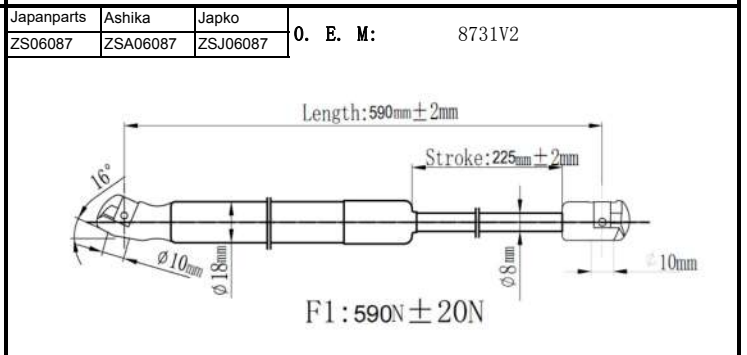
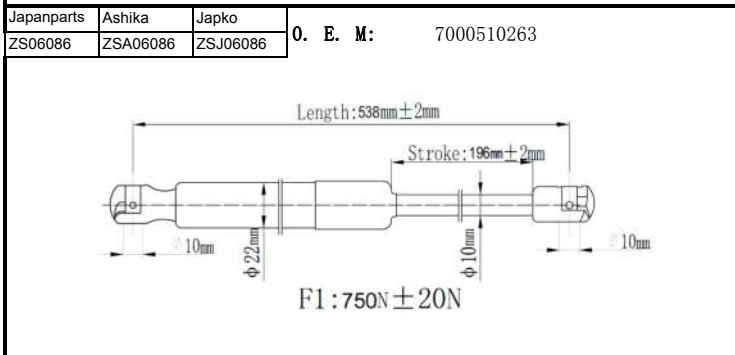
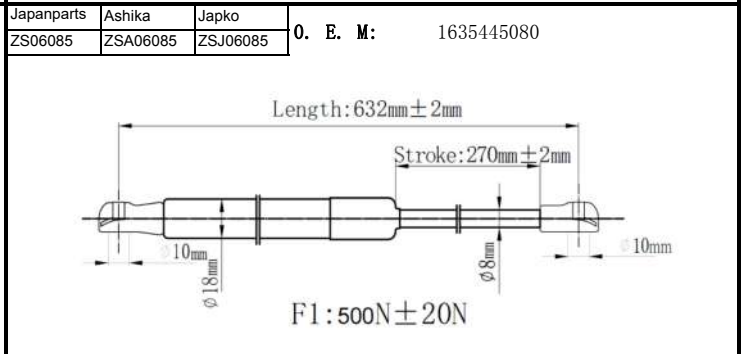
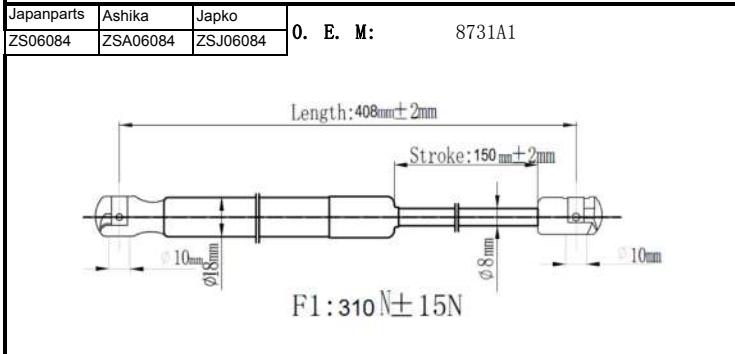
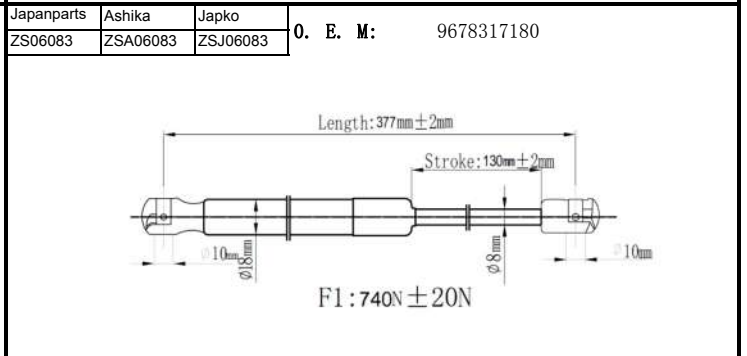
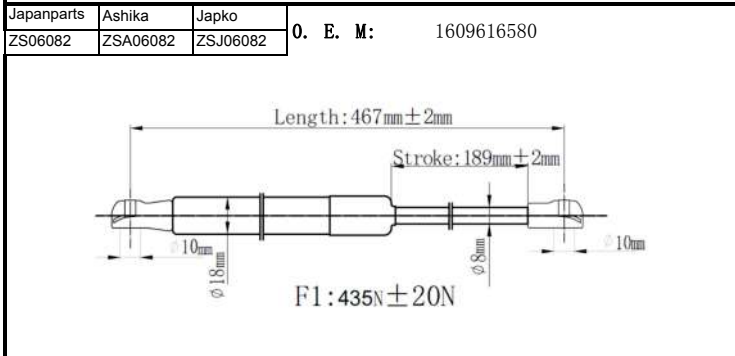
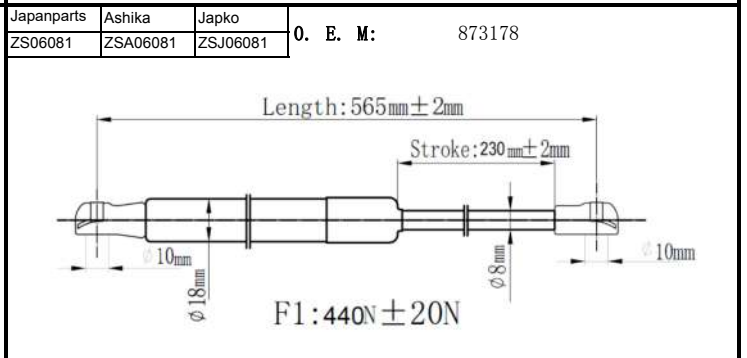
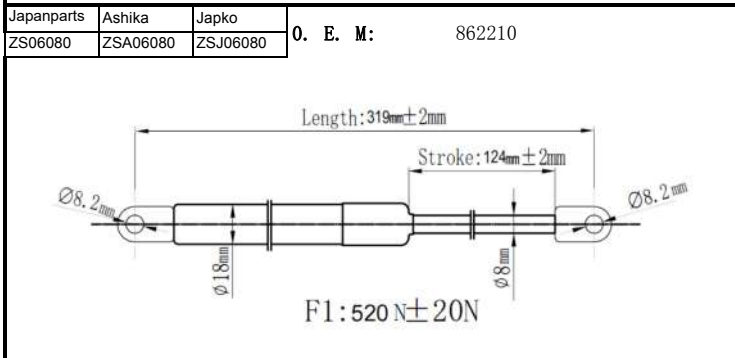
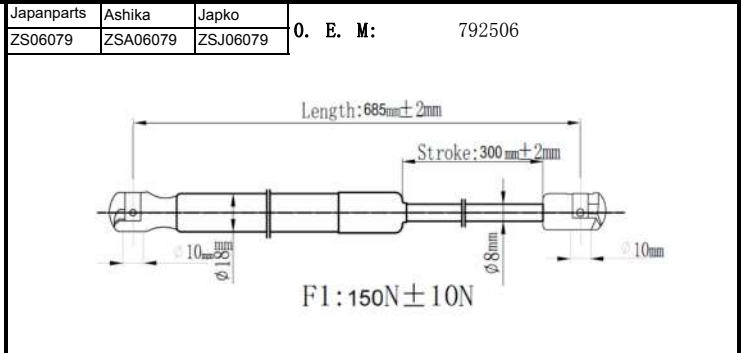
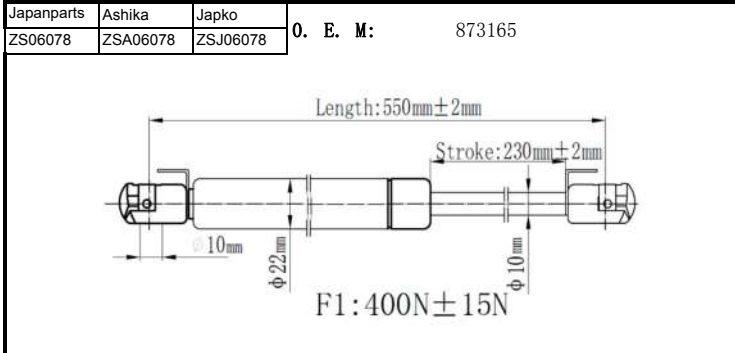
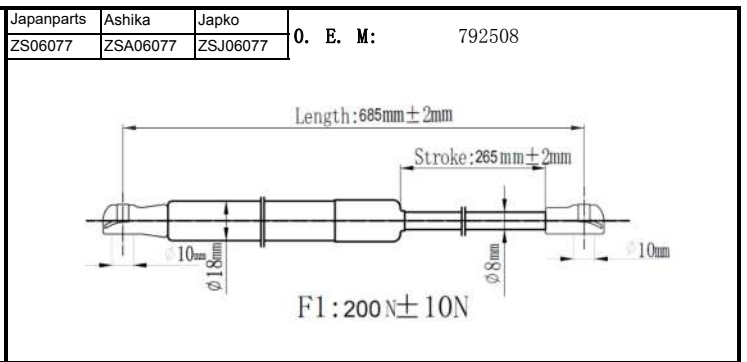
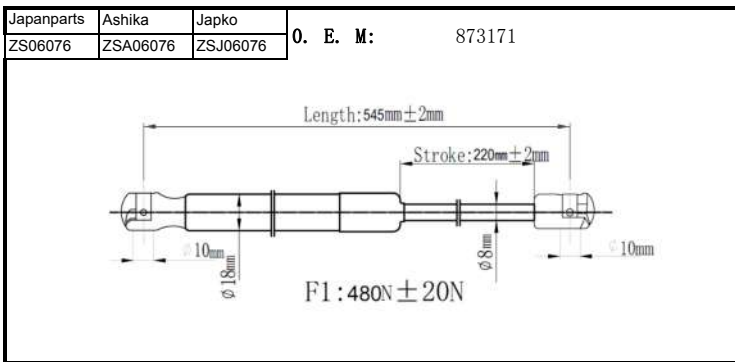

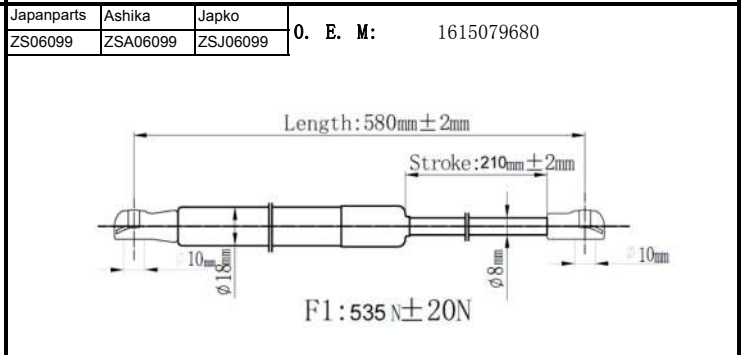
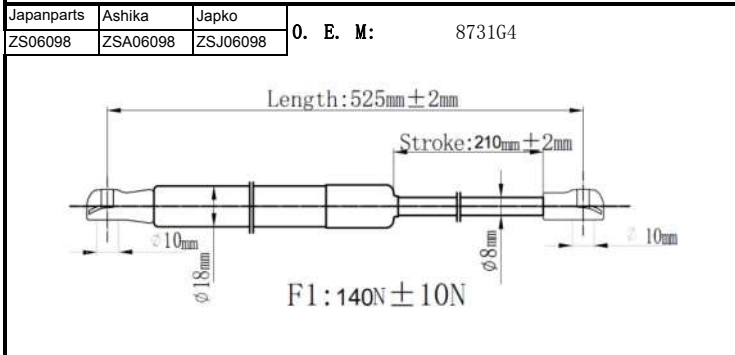
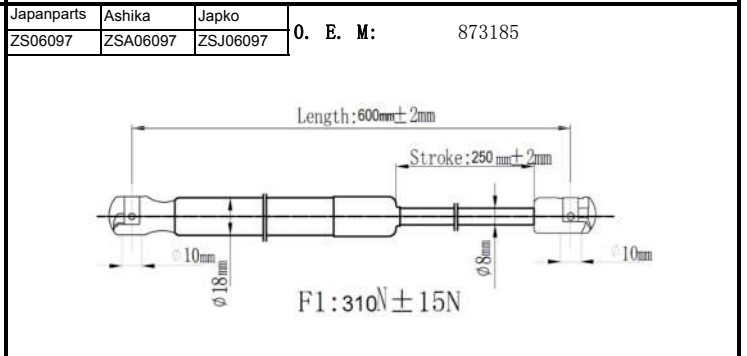
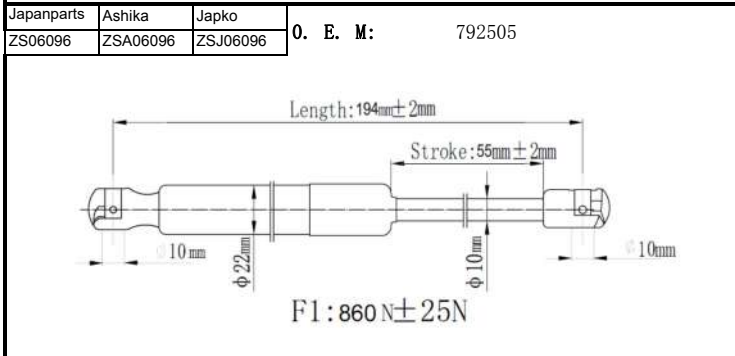
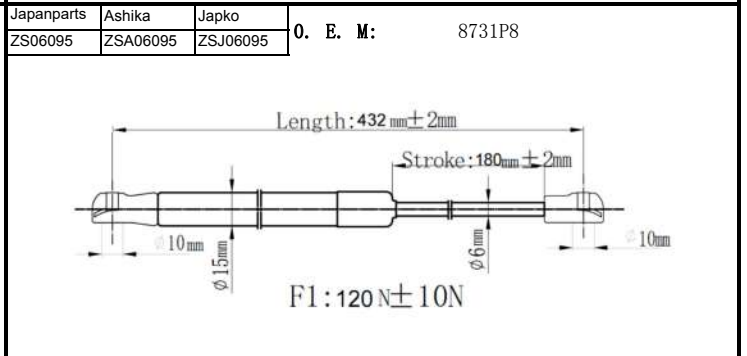
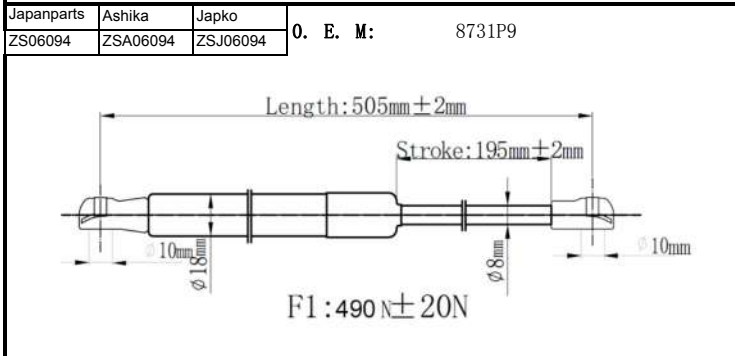
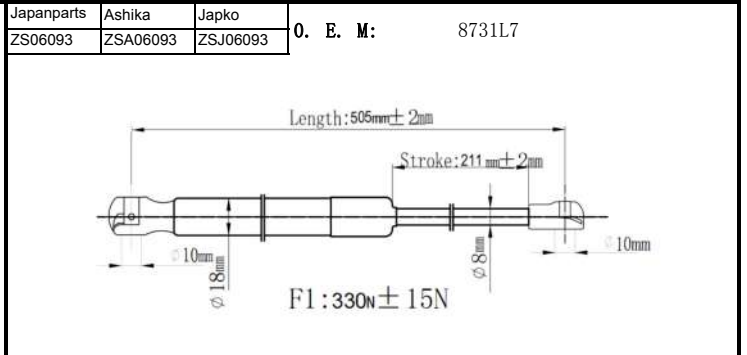
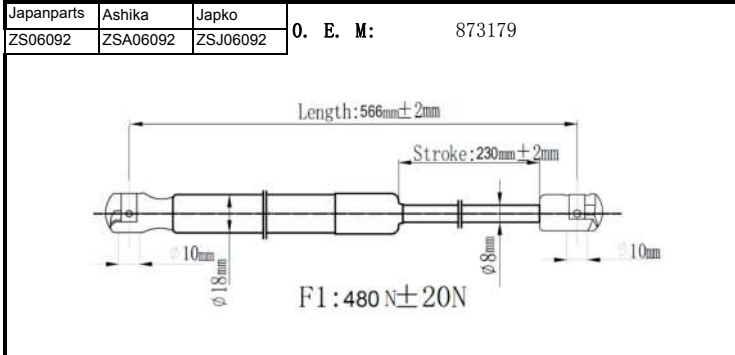
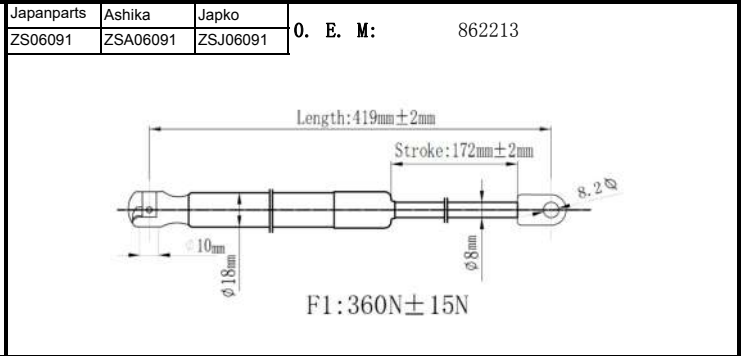
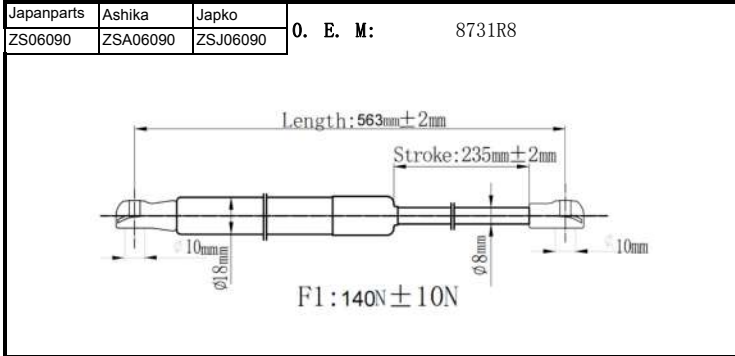
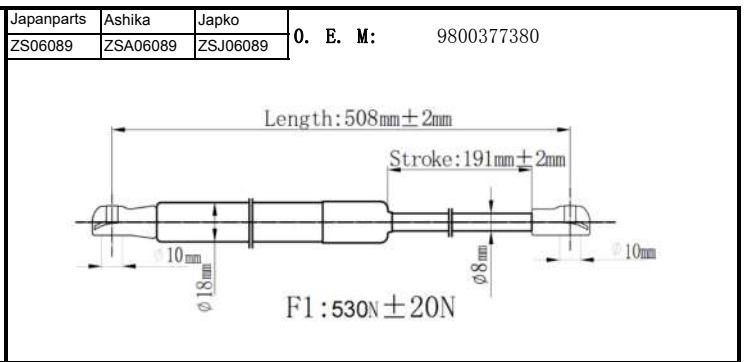
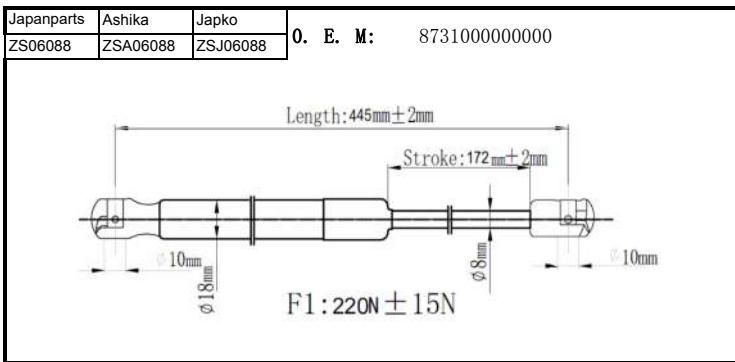

| | | |
|------------|----------|----------|
| Japanparts | Ashika | Japko |
| ZS06100 | ZSA06100 | ZSJ06100 |

O. E. M.: 673191

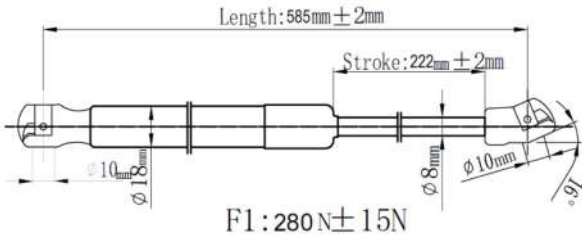

| | | |
|------------|----------|----------|
| Japanparts | Ashika | Japko |
| ZS06101 | ZSA06101 | ZSJ06101 |

O. E. M.: 873183

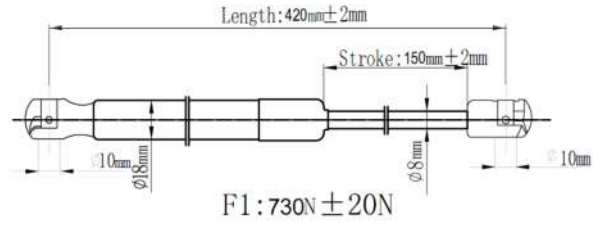

| | | |
|------------|----------|----------|
| Japanparts | Ashika | Japko |
| ZS06102 | ZSA06102 | ZSJ06102 |

O. E. M.: 873155

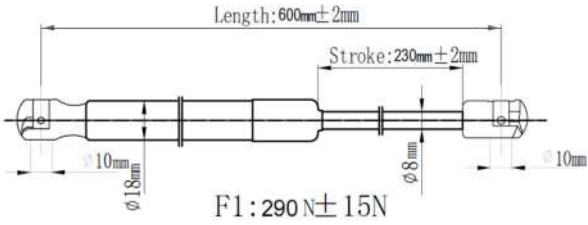

| | | |
|------------|----------|----------|
| Japanparts | Ashika | Japko |
| ZS06103 | ZSA06103 | ZSJ06103 |

O. E. M.: 8731C9

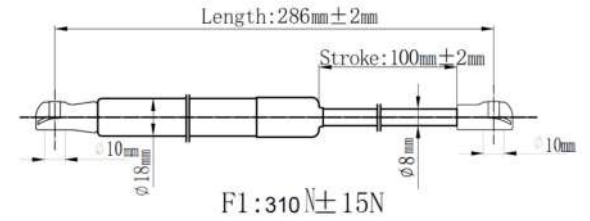

| | | |
|------------|----------|----------|
| Japanparts | Ashika | Japko |
| ZS06104 | ZSA06104 | ZSJ06104 |

O. E. M.: 862215

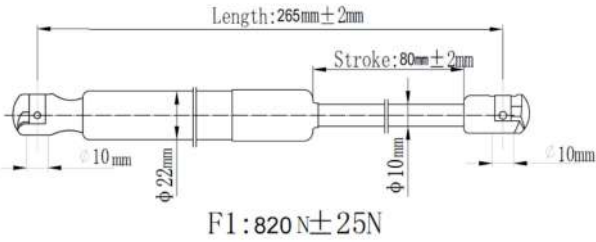

| | | |
|------------|----------|----------|
| Japanparts | Ashika | Japko |
| ZS06105 | ZSA06105 | ZSJ06105 |

O. E. M.: 8731L2

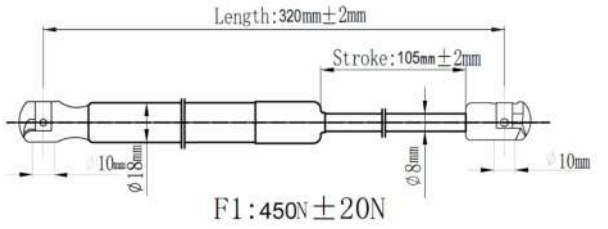

| | | |
|------------|----------|----------|
| Japanparts | Ashika | Japko |
| ZS06106 | ZSA06106 | ZSJ06106 |

O. E. M.: 8731W3

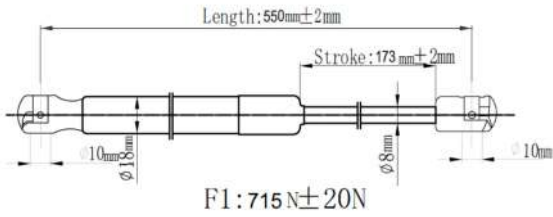

| | | |
|------------|----------|----------|
| Japanparts | Ashika | Japko |
| ZS07000 | ZSA07000 | ZSJ07000 |

O. E. M.: 9045000Q0A

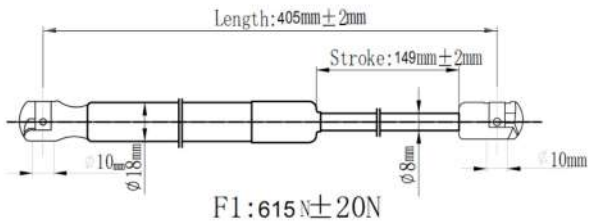

| | | |
|------------|----------|----------|
| Japanparts | Ashika | Japko |
| ZS07001 | ZSA07001 | ZSJ07001 |

O. E. M.: 7700421906

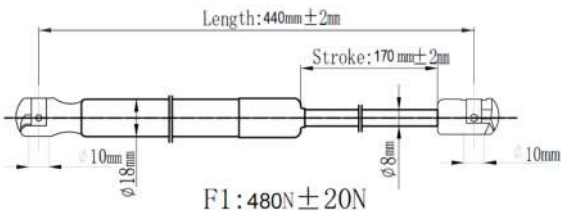

| | | |
|------------|----------|----------|
| Japanparts | Ashika | Japko |
| ZS07002 | ZSA07002 | ZSJ07002 |

O. E. M.: 8200051750

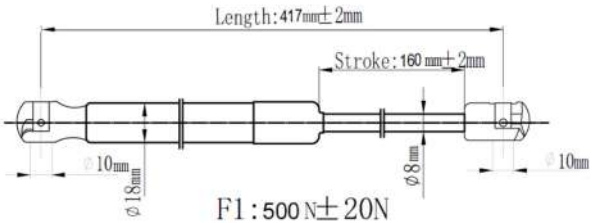

| | | |
|------------|----------|----------|
| Japanparts | Ashika | Japko |
| ZS07003 | ZSA07003 | ZSJ07003 |

O. E. M.: 82 00 003 020

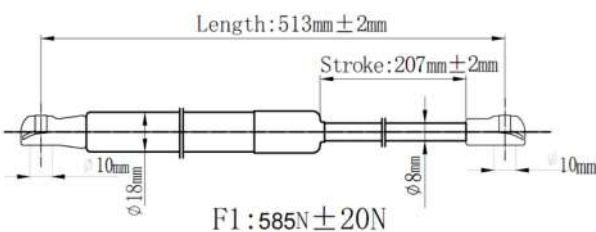

| | | |
|------------|----------|----------|
| Japanparts | Ashika | Japko |
| ZS07004 | ZSA07004 | ZSJ07004 |

O. E. M.: 8200000903

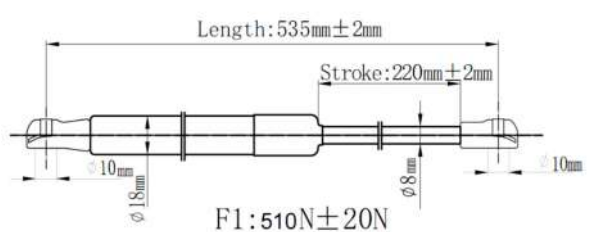

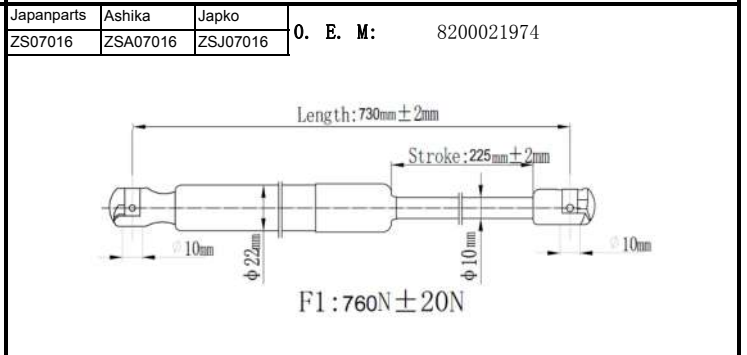
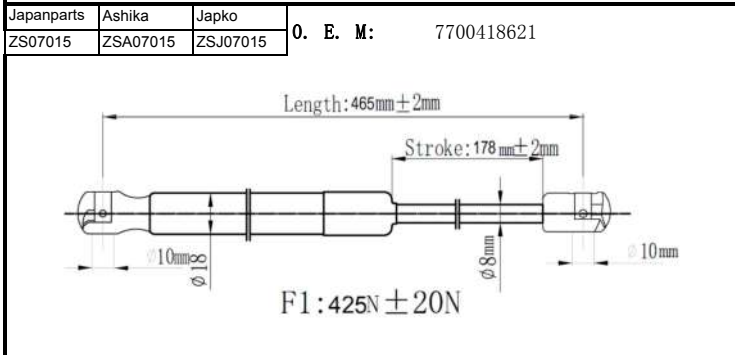
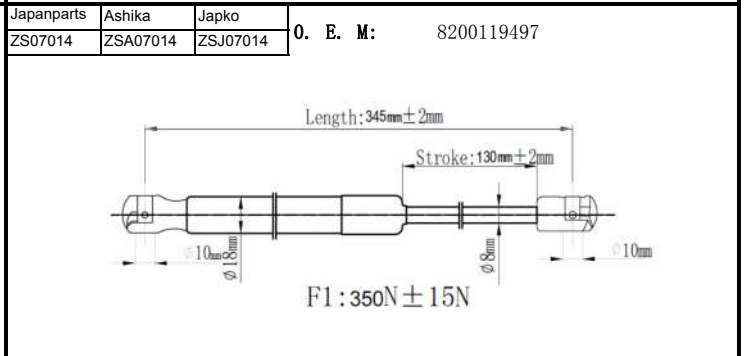
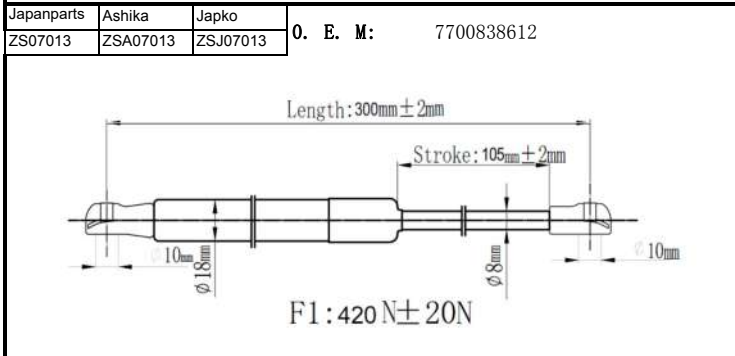
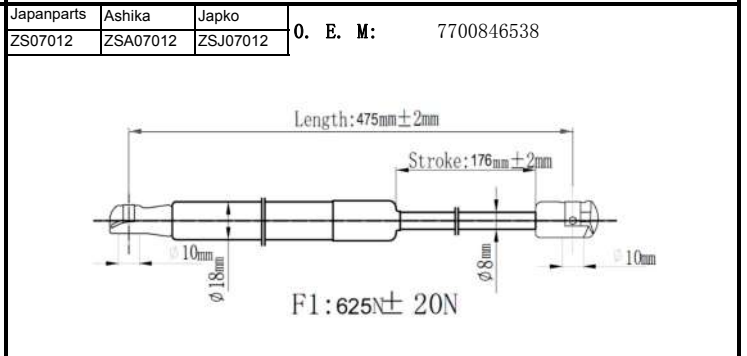
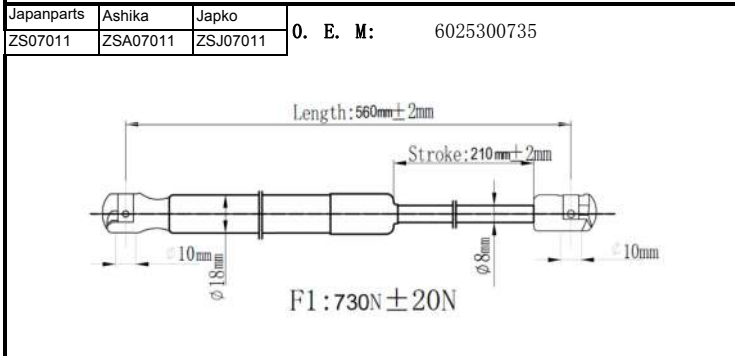
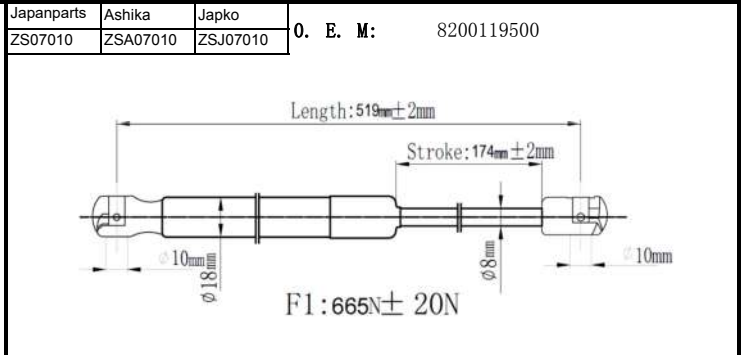
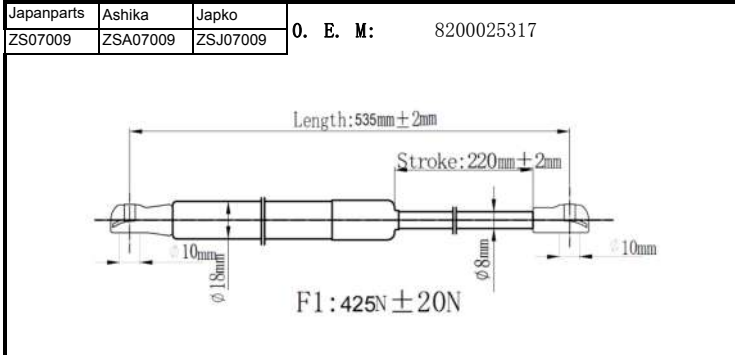
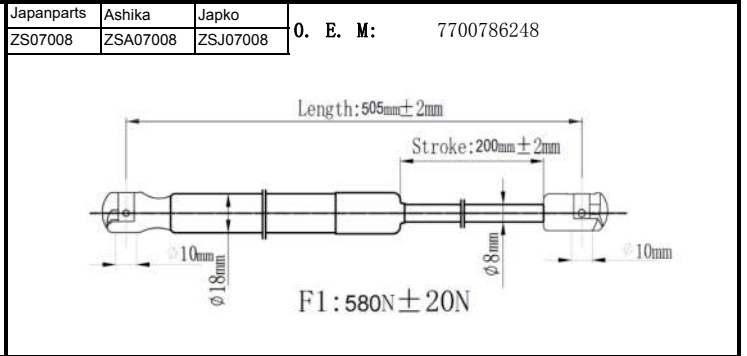
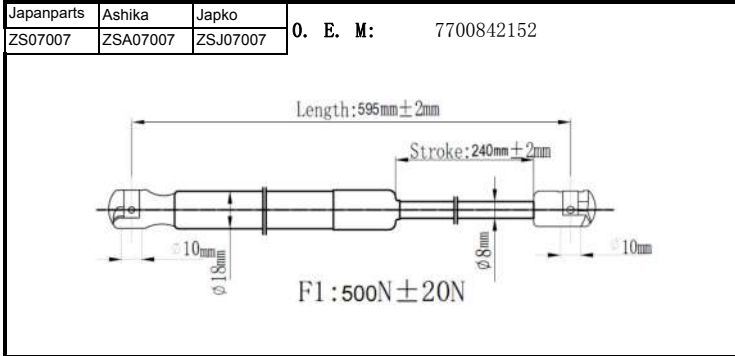
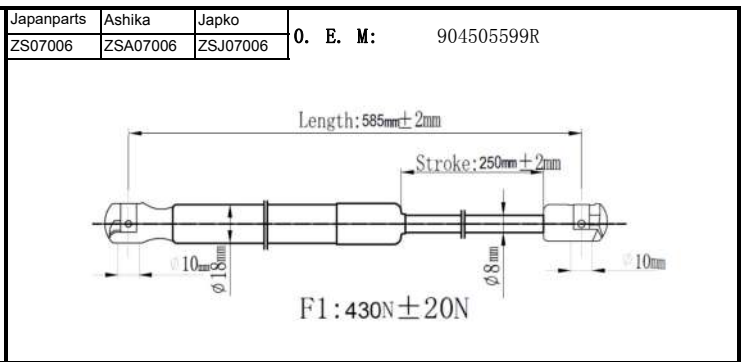
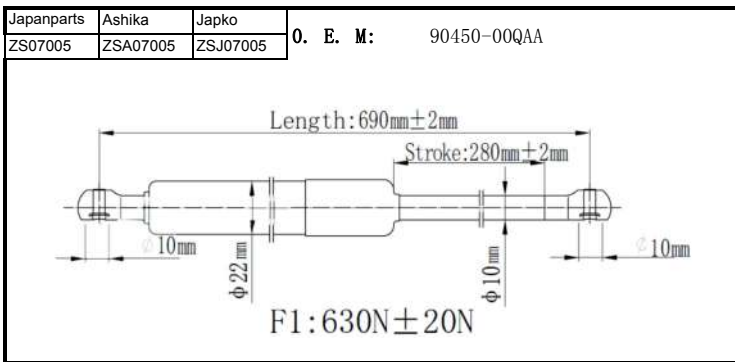

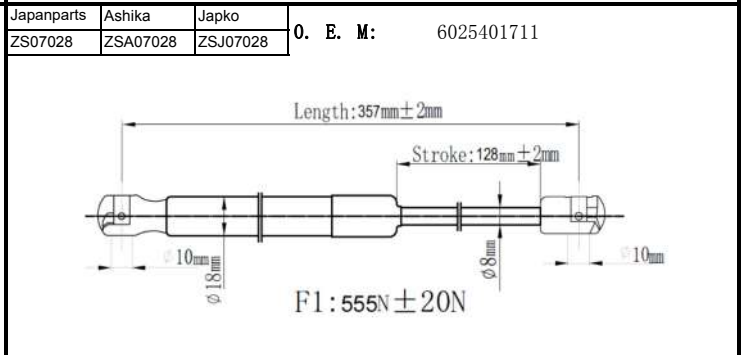
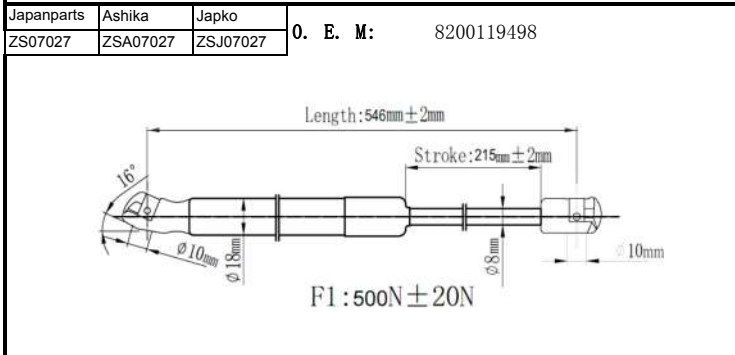
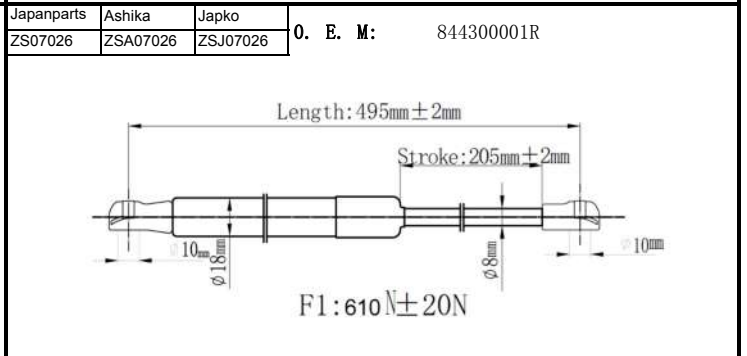
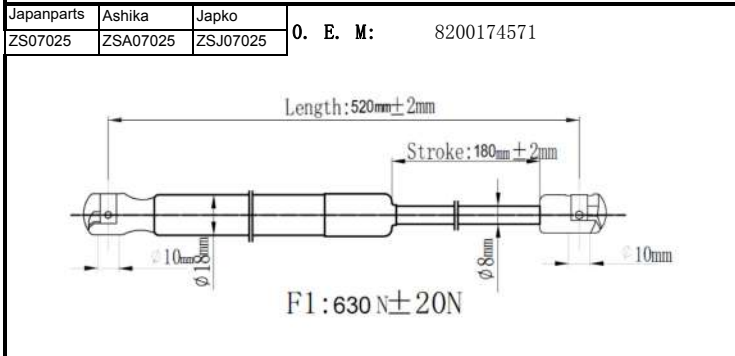
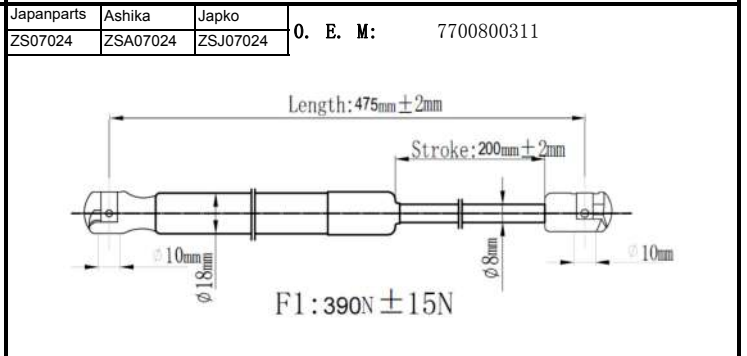
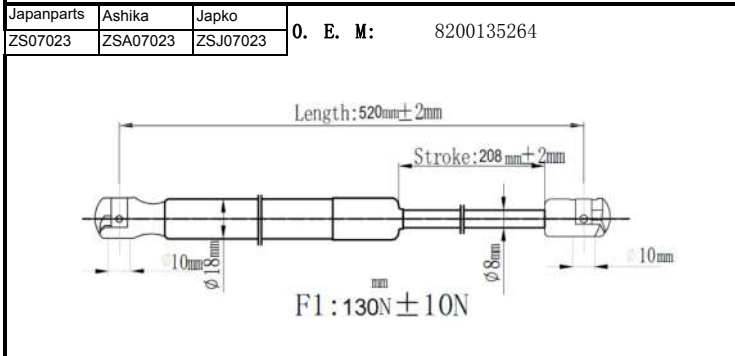
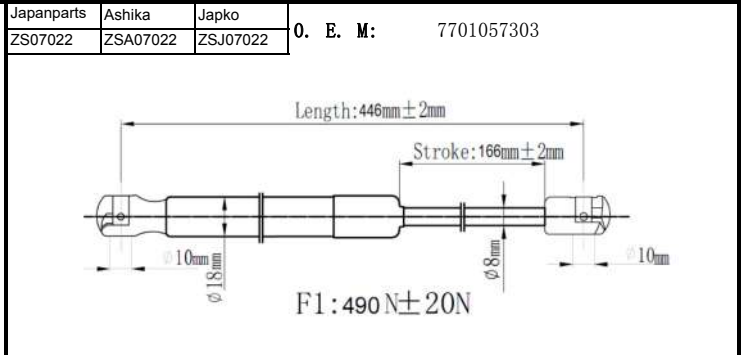
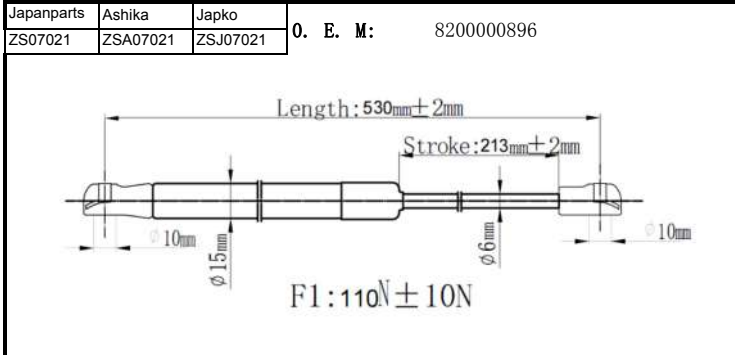
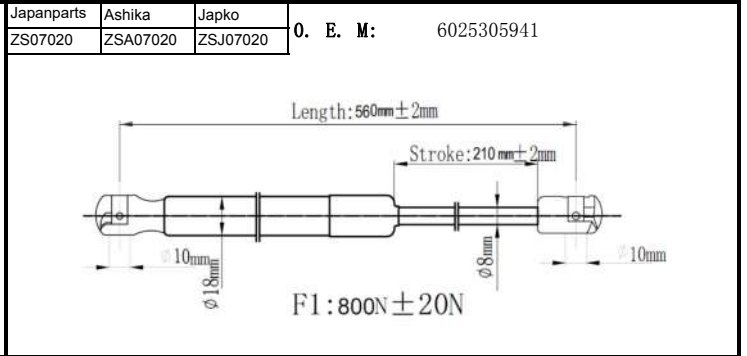
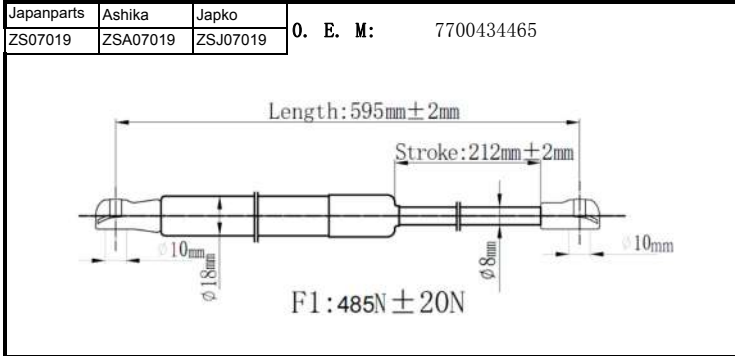
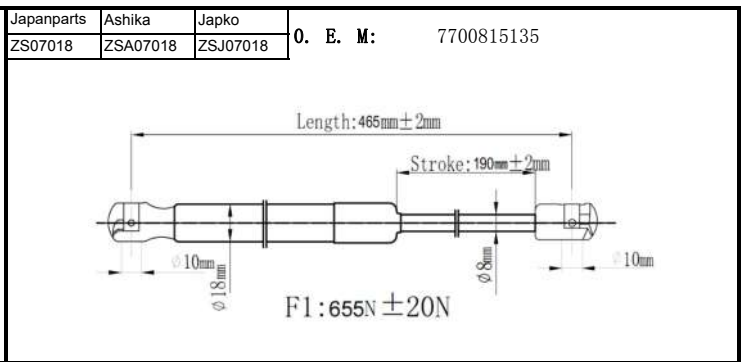
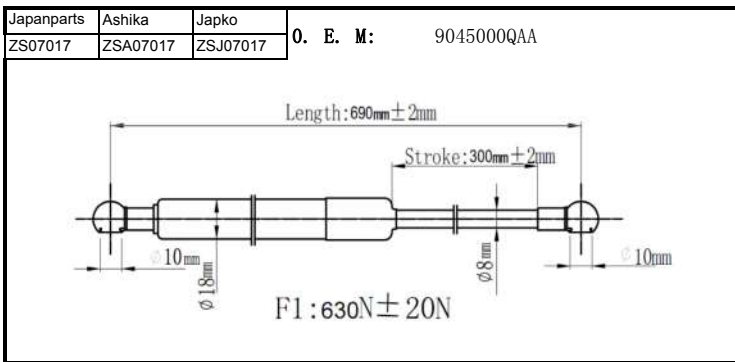

| | | |
|------------|----------|----------|
| Japanparts | Ashika | Japko |
| ZS07029 | ZSA07029 | ZSJ07029 |

O. E. M: 51051703

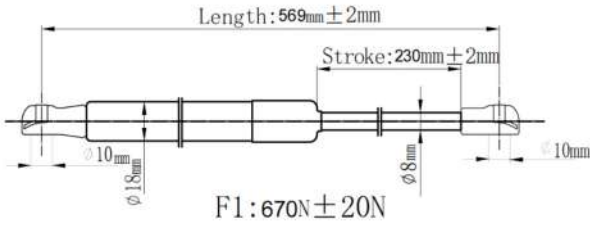

| | | |
|------------|----------|----------|
| Japanparts | Ashika | Japko |
| ZS07030 | ZSA07030 | ZSJ07030 |

O. E. M: 6025306563

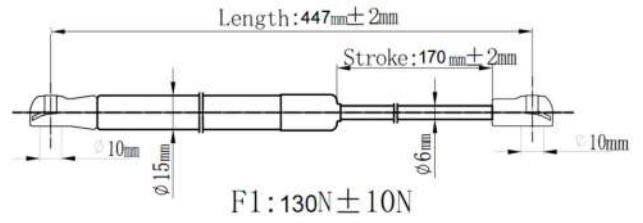

| | | |
|------------|----------|----------|
| Japanparts | Ashika | Japko |
| ZS07031 | ZSA07031 | ZSJ07031 |

O. E. M: 7700430022

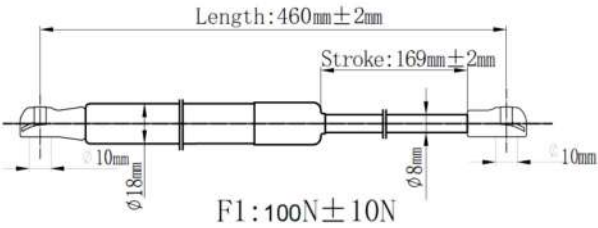

| | | |
|------------|----------|----------|
| Japanparts | Ashika | Japko |
| ZS07032 | ZSA07032 | ZSJ07032 |

O. E. M: 8463528

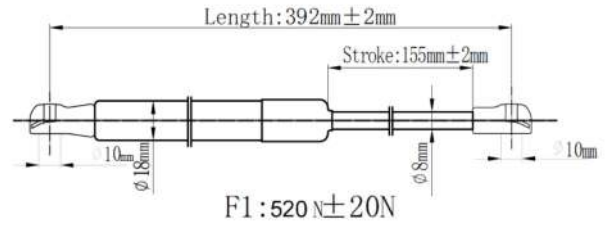

| | | |
|------------|----------|----------|
| Japanparts | Ashika | Japko |
| ZS07033 | ZSA07033 | ZSJ07033 |

O. E. M: 7000210536A0

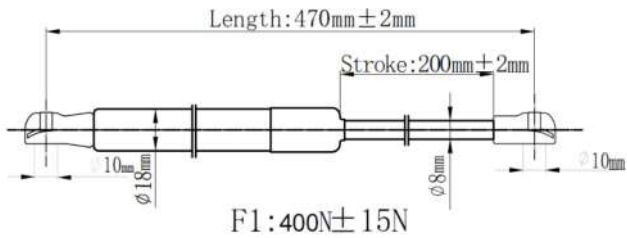

| | | |
|------------|----------|----------|
| Japanparts | Ashika | Japko |
| ZS07034 | ZSA07034 | ZSJ07034 |

O. E. M: 6025106762

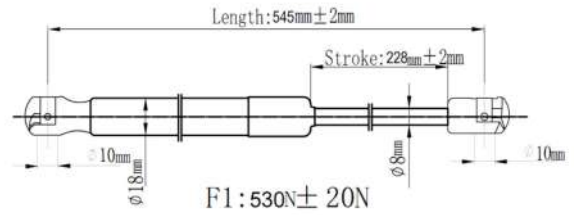

| | | |
|------------|----------|----------|
| Japanparts | Ashika | Japko |
| ZS07035 | ZSA07035 | ZSJ07035 |

O. E. M: 7700811019

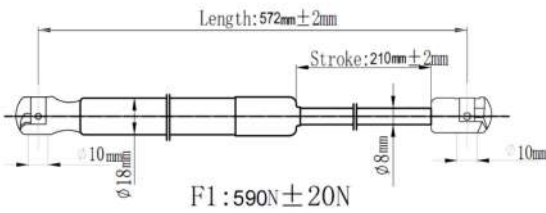

| | | |
|------------|----------|----------|
| Japanparts | Ashika | Japko |
| ZS07036 | ZSA07036 | ZSJ07036 |

O. E. M: 7700842256

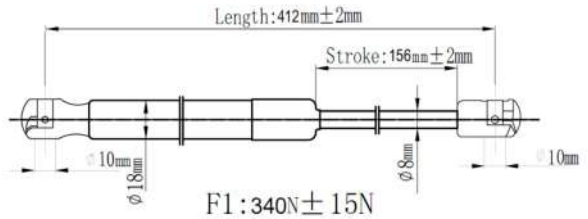

| | | |
|------------|----------|----------|
| Japanparts | Ashika | Japko |
| ZS07037 | ZSA07037 | ZSJ07037 |

O. E. M: 7700756056

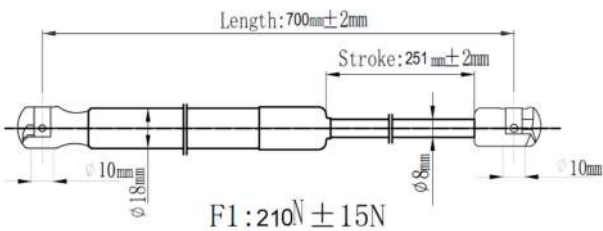

| | | |
|------------|----------|----------|
| Japanparts | Ashika | Japko |
| ZS07038 | ZSA07038 | ZSJ07038 |

O. E. M: 7700812193

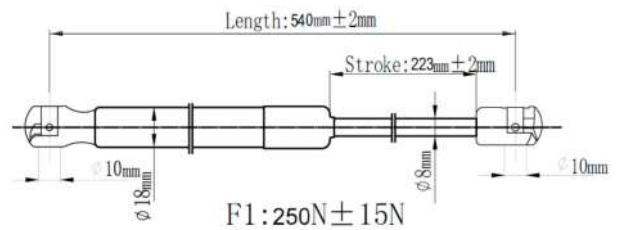

| | | |
|------------|----------|----------|
| Japanparts | Ashika | Japko |
| ZS07039 | ZSA07039 | ZSJ07039 |

O. E. M: 7700828487

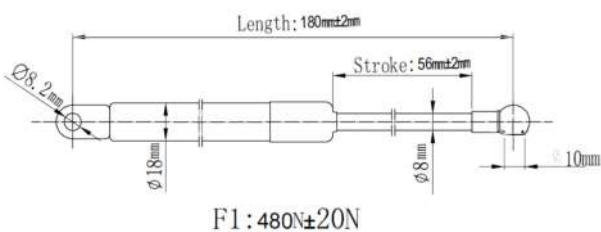

| | | |
|------------|----------|----------|
| Japanparts | Ashika | Japko |
| ZS07040 | ZSA07040 | ZSJ07040 |

O. E. M: 654703934R

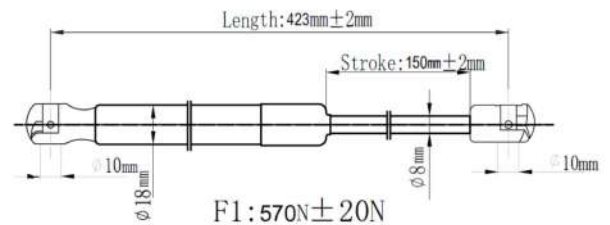

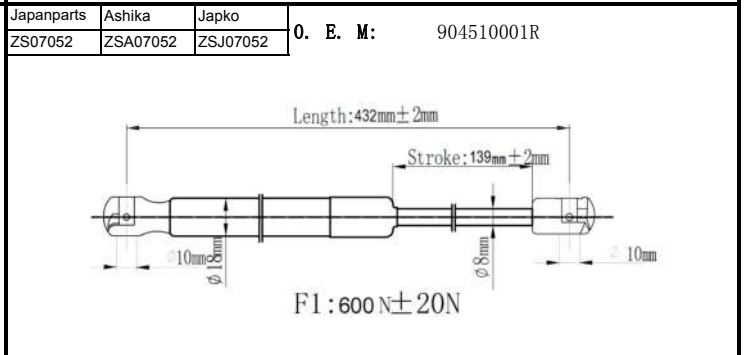
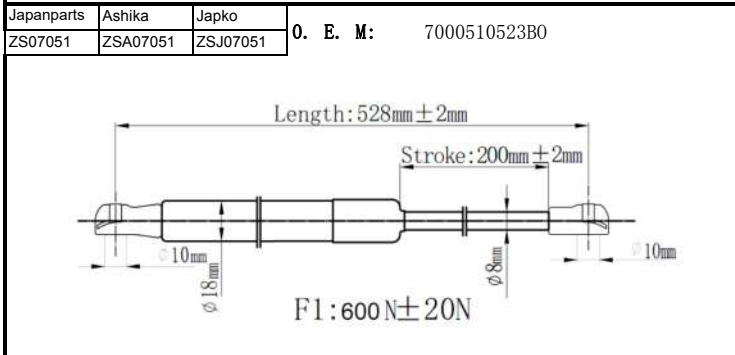
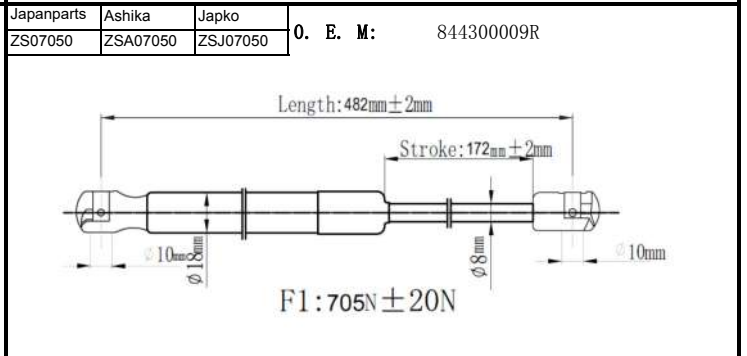
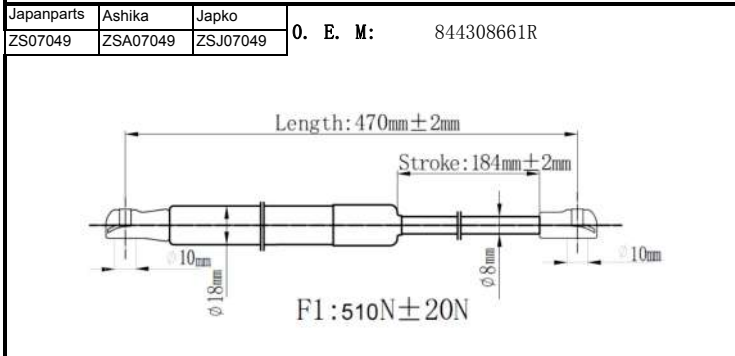
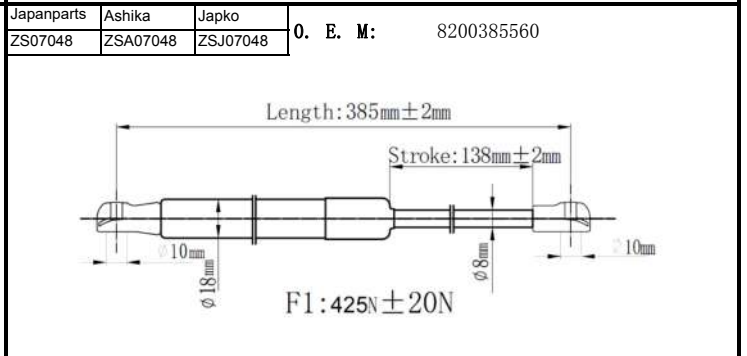
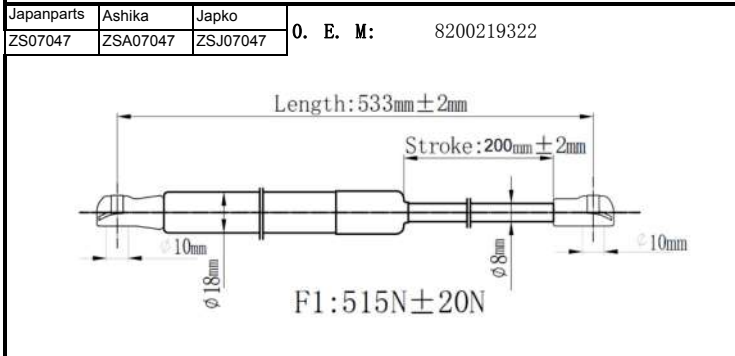
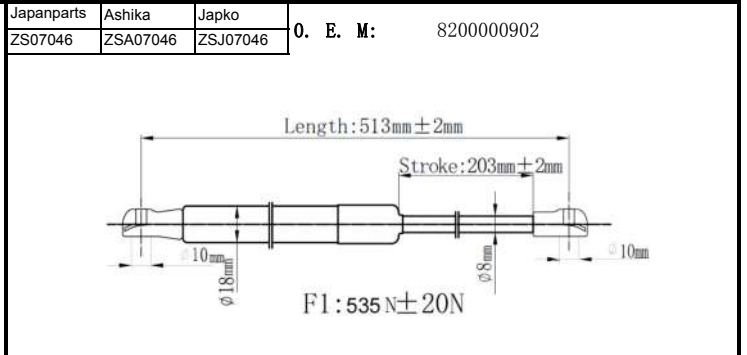
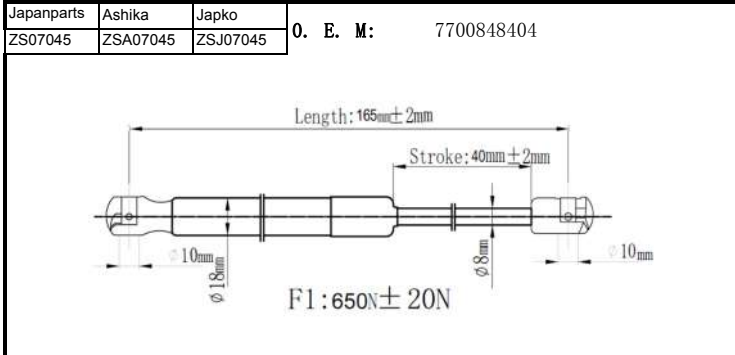
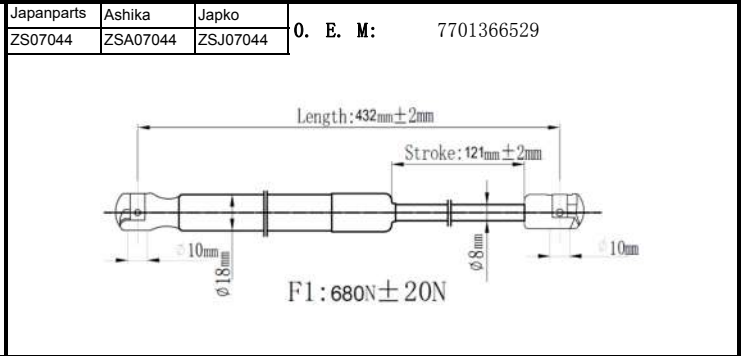
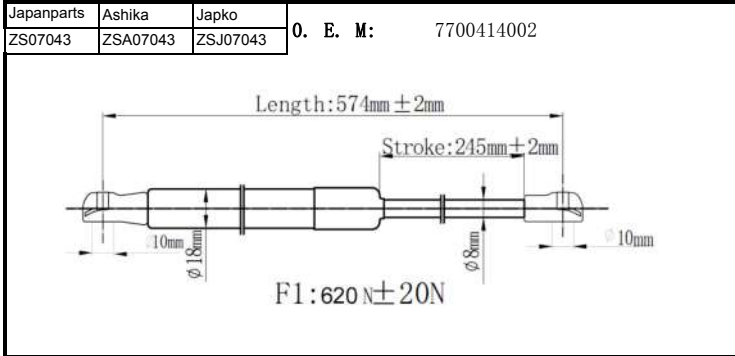
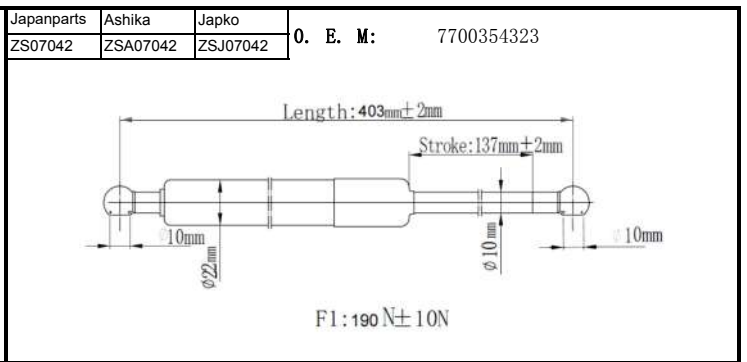
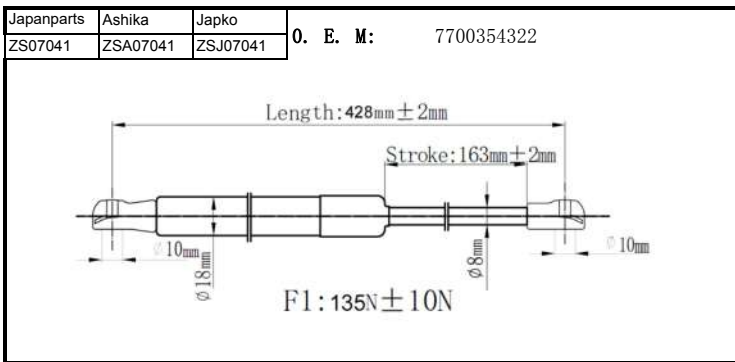

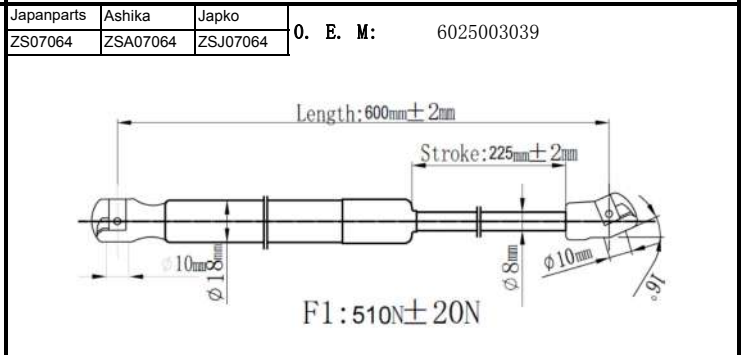
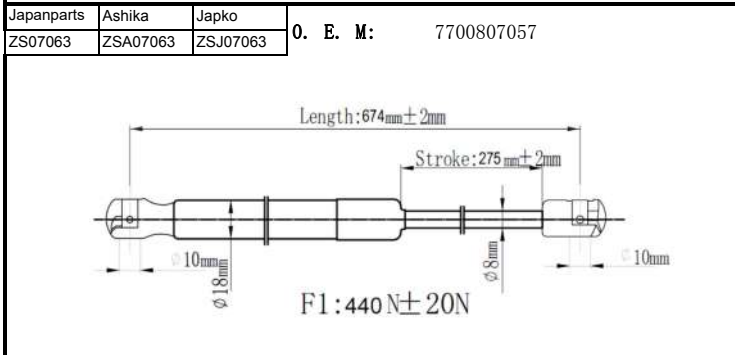
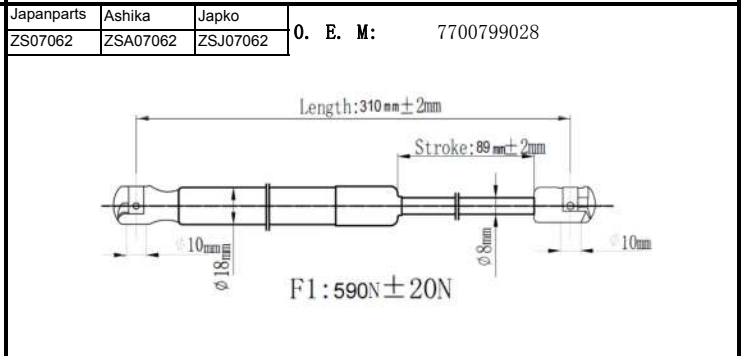
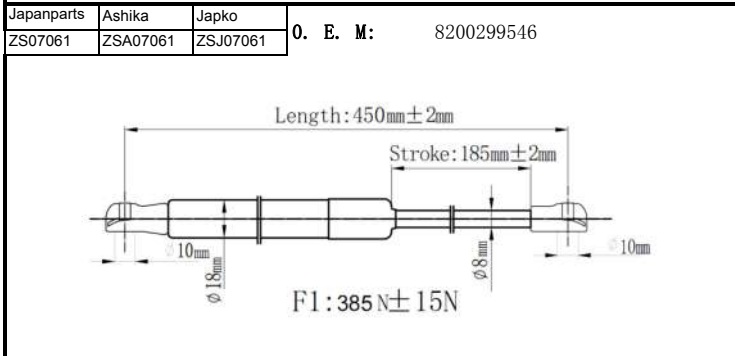
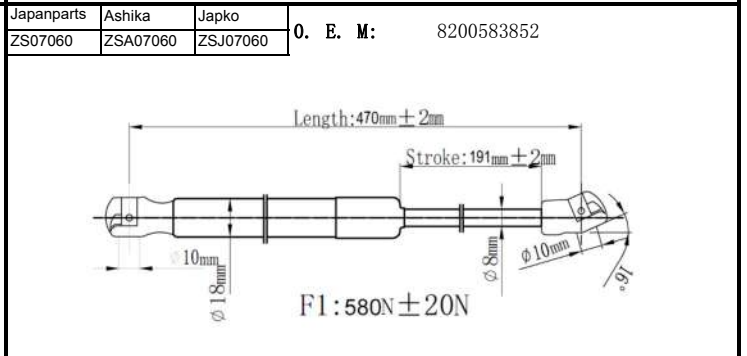
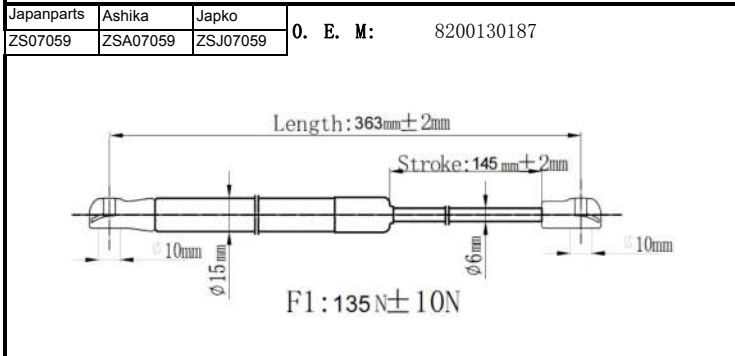
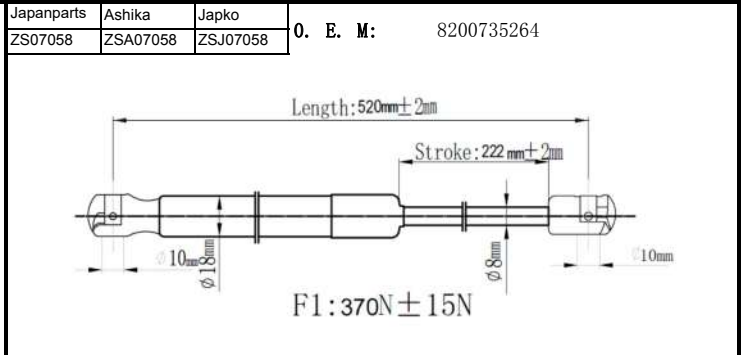
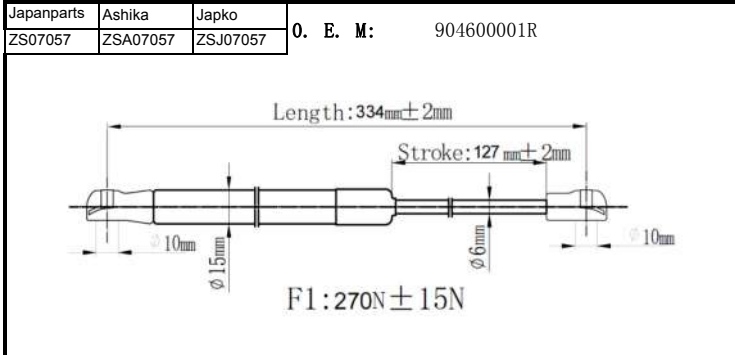
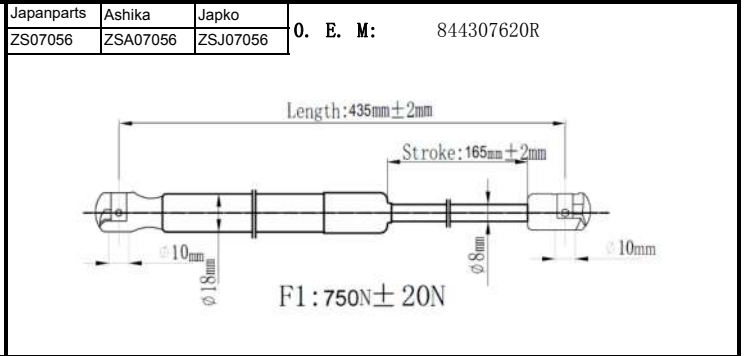
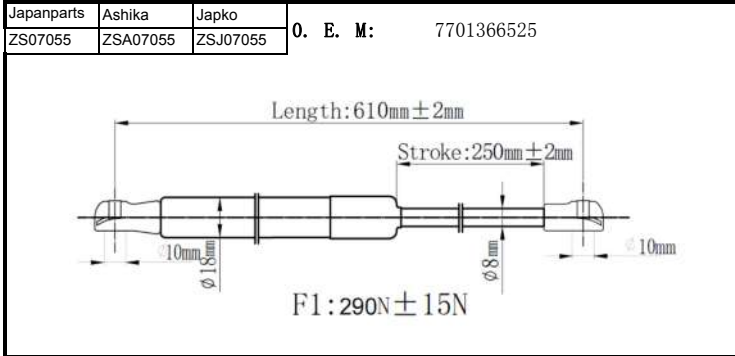
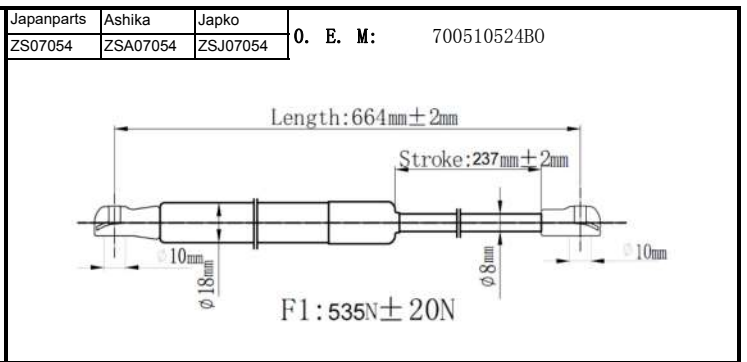
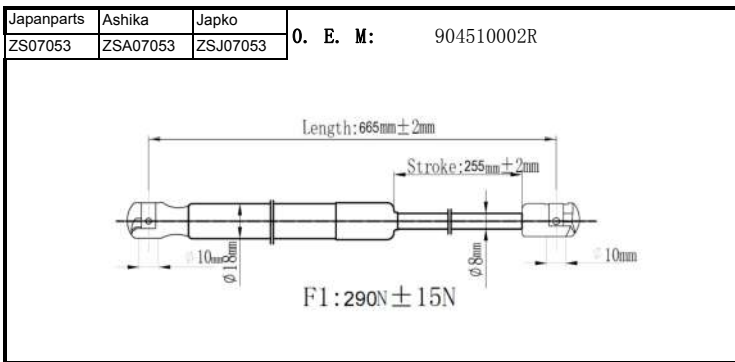

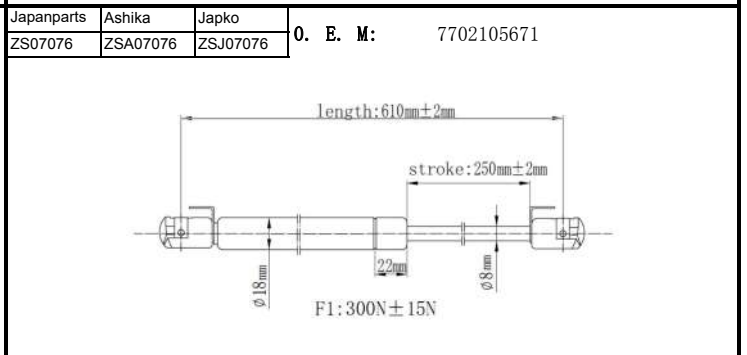
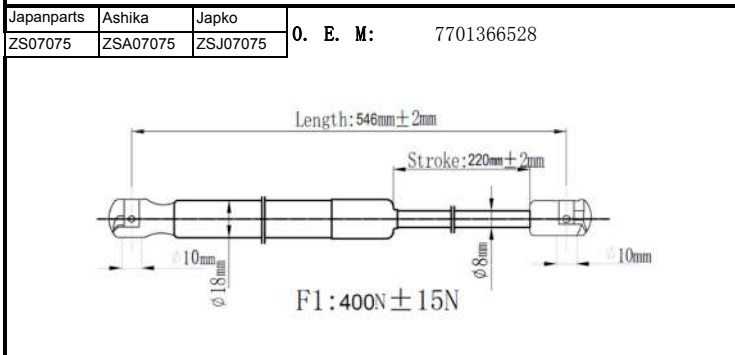
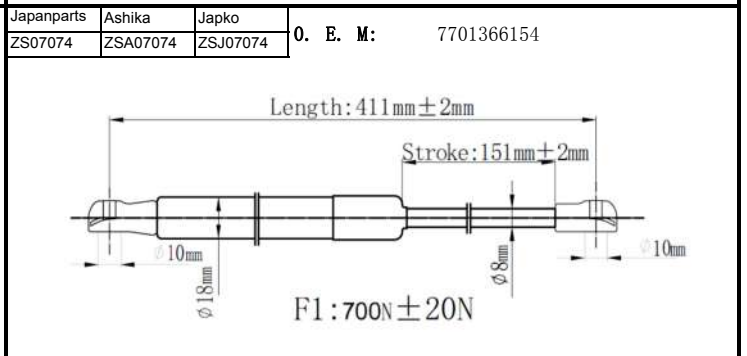
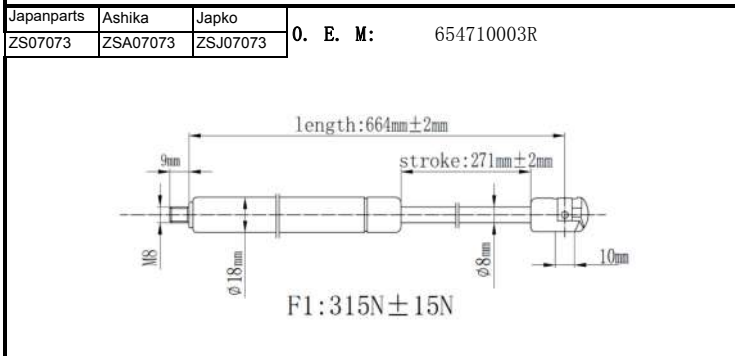
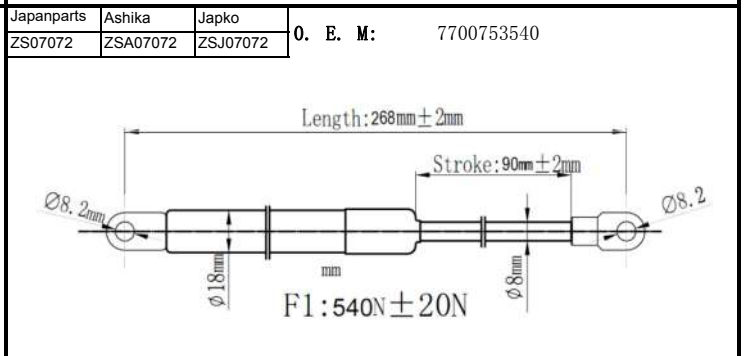
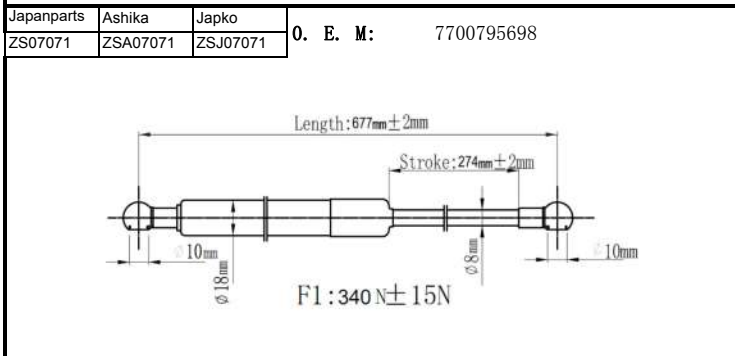
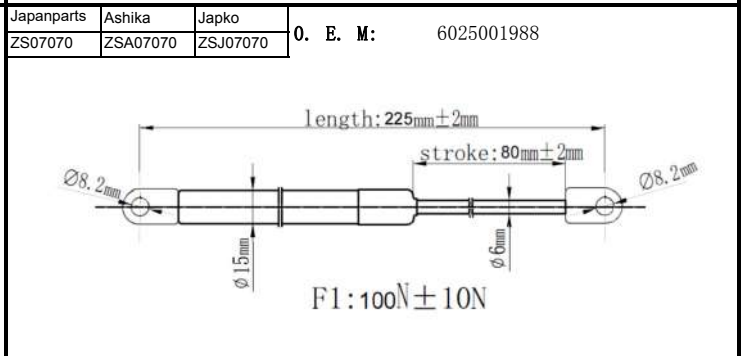
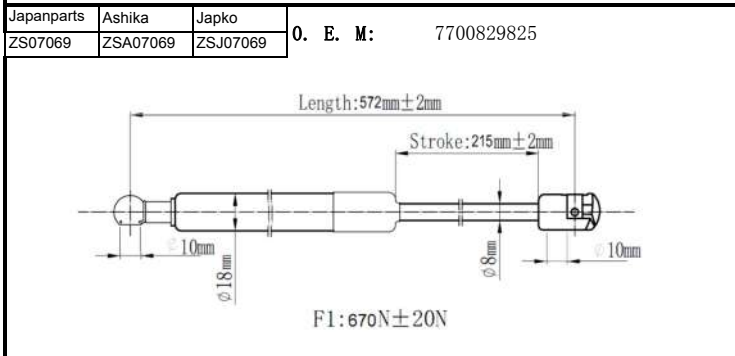
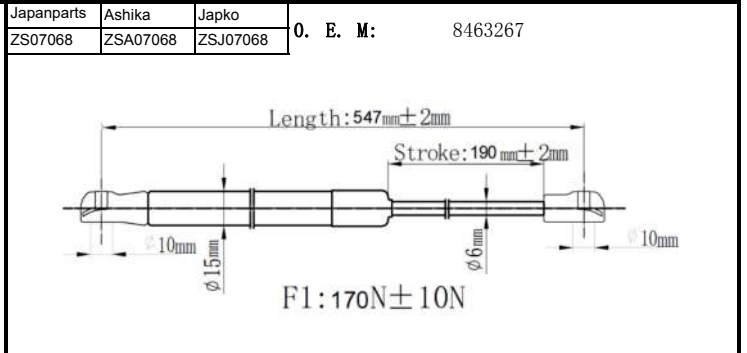
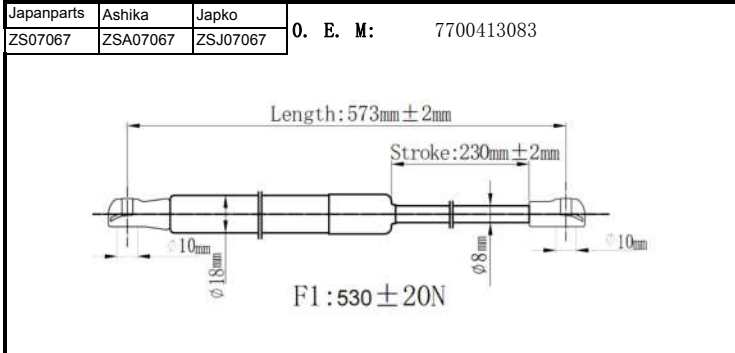
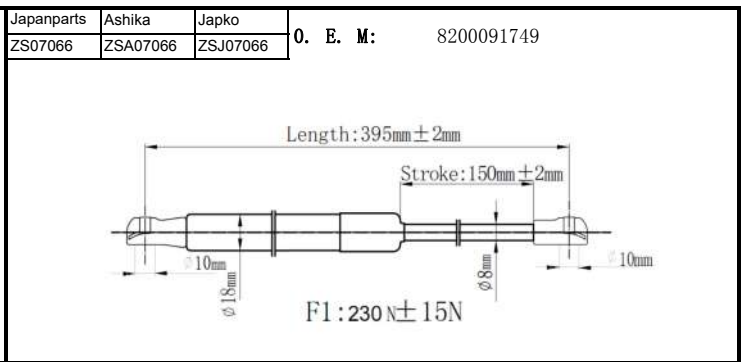
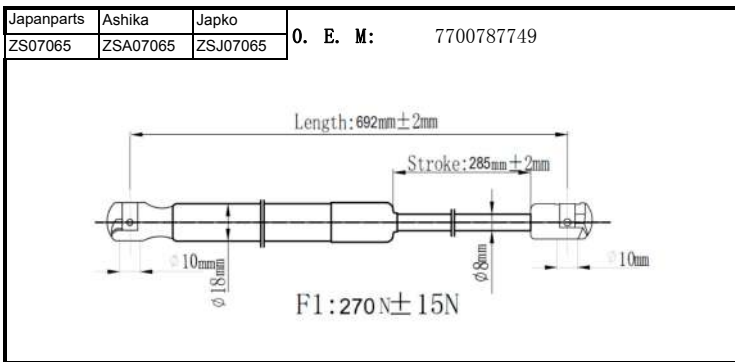

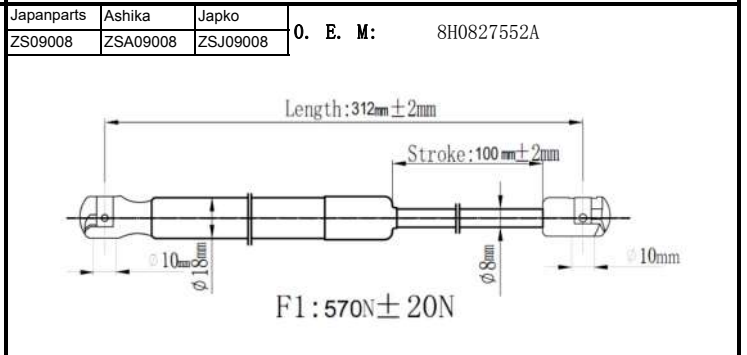
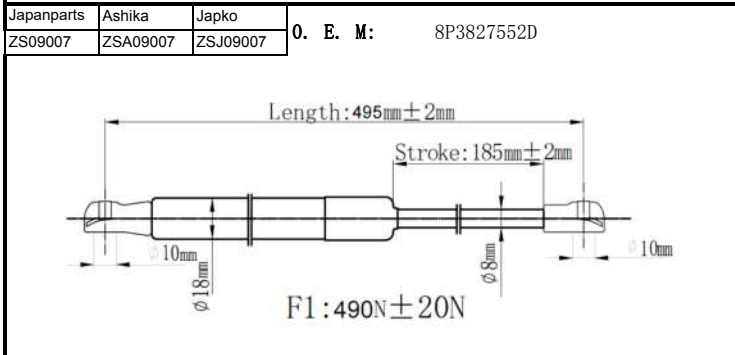
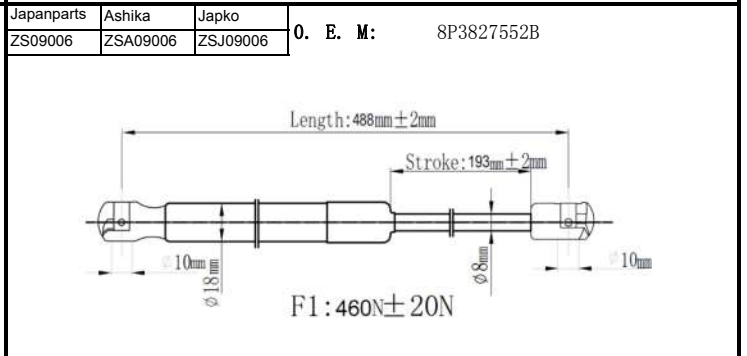
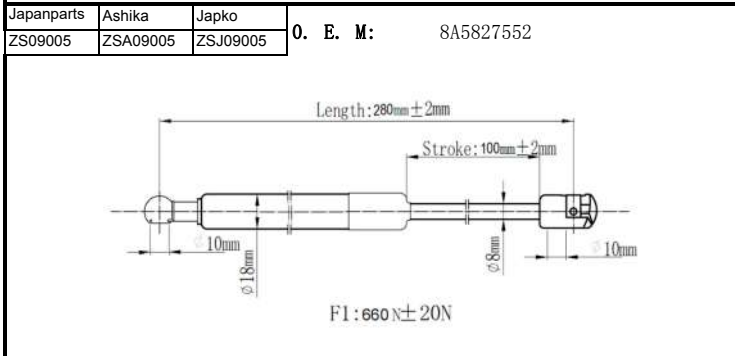
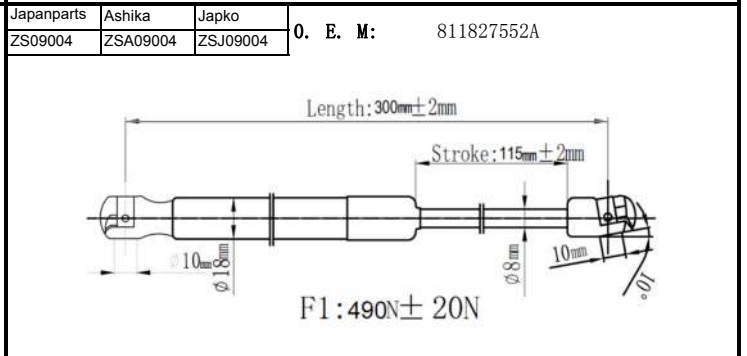
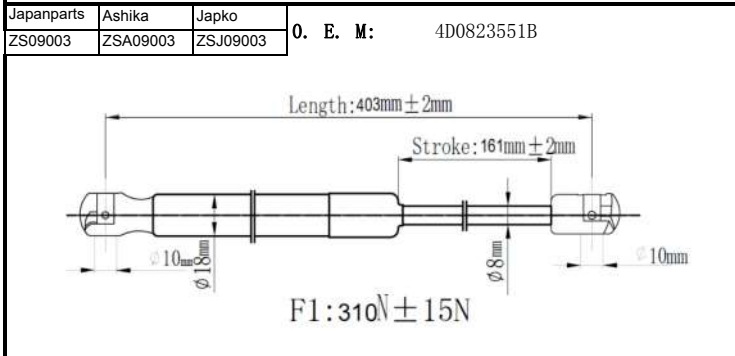
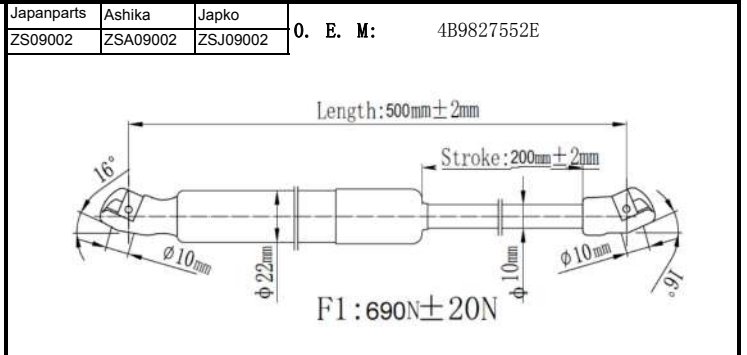
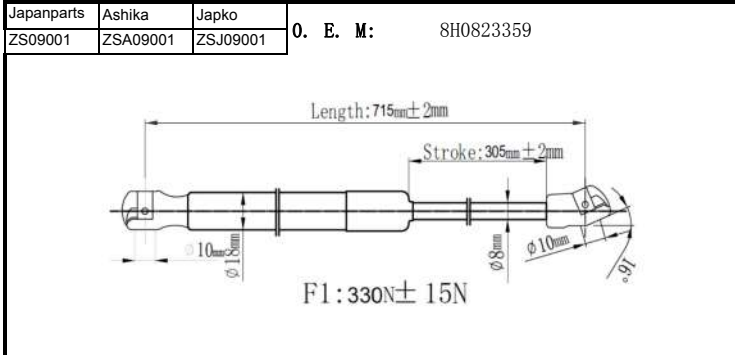
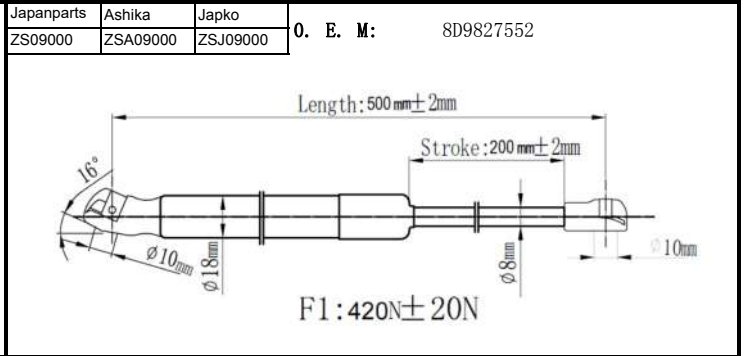
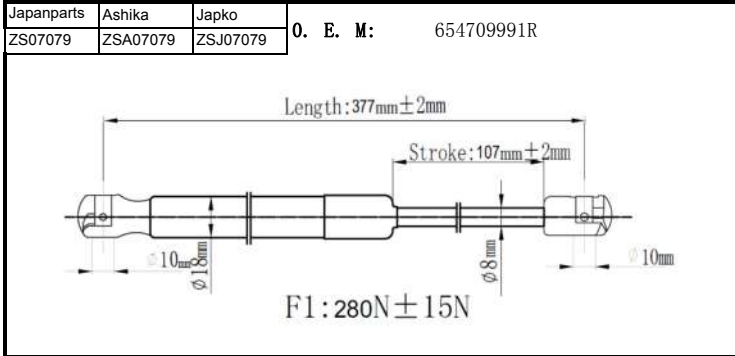
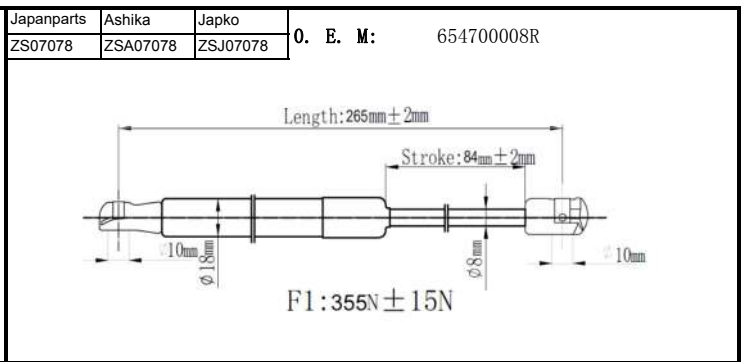
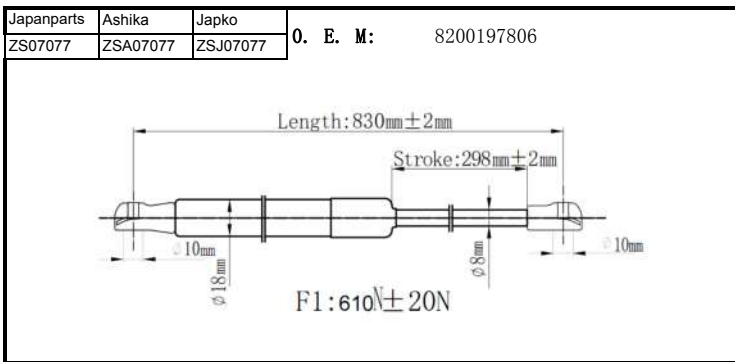

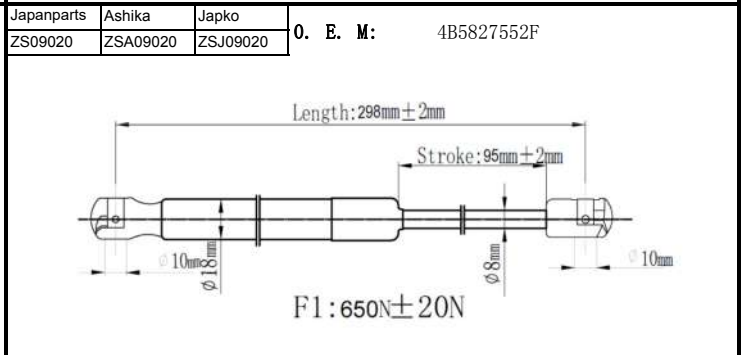
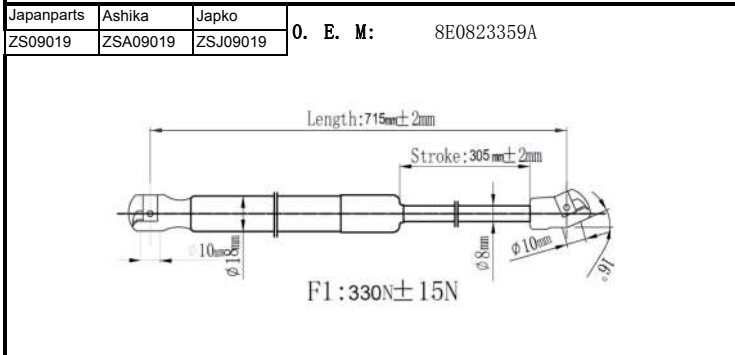
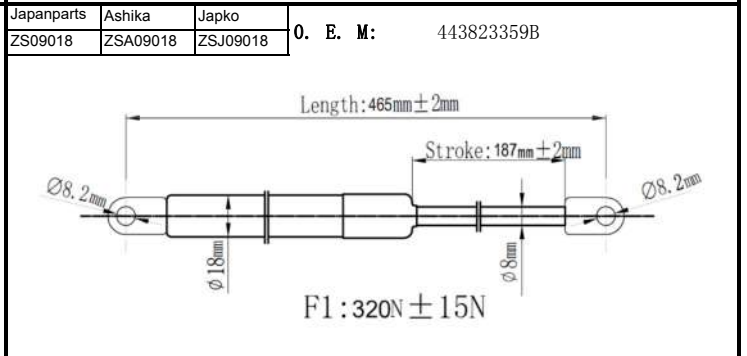
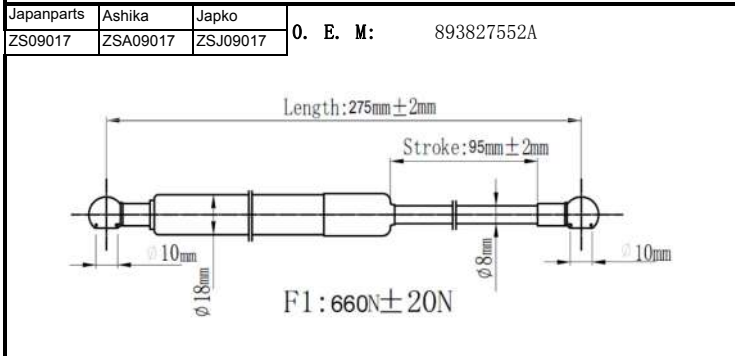
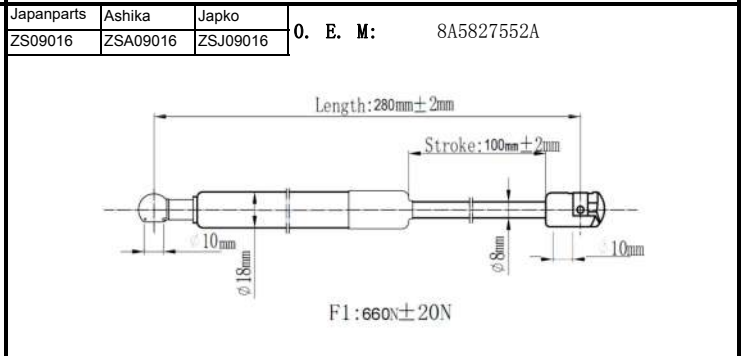
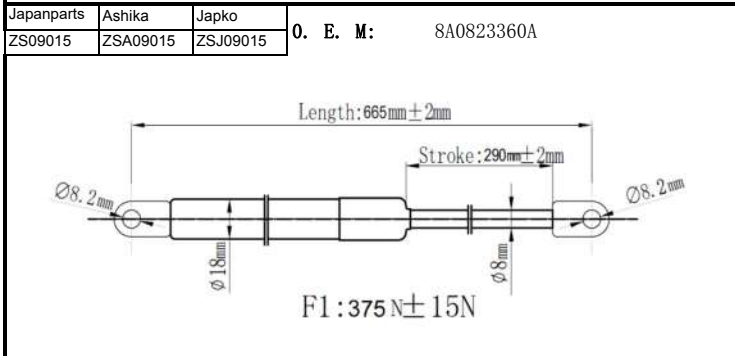
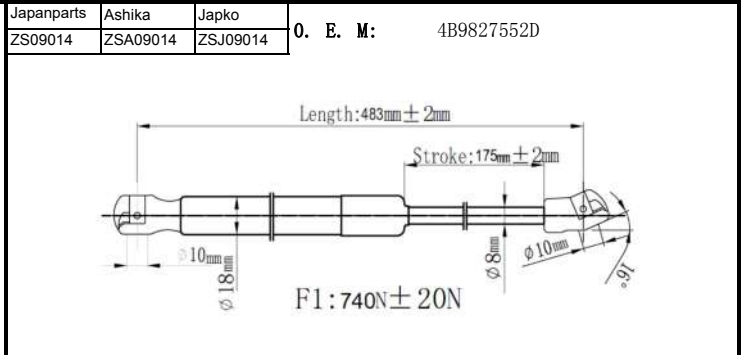
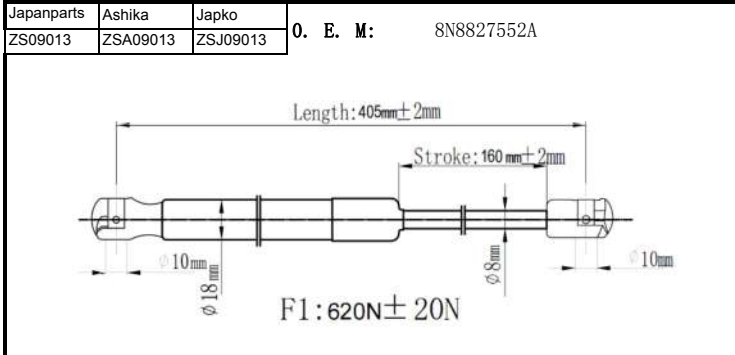
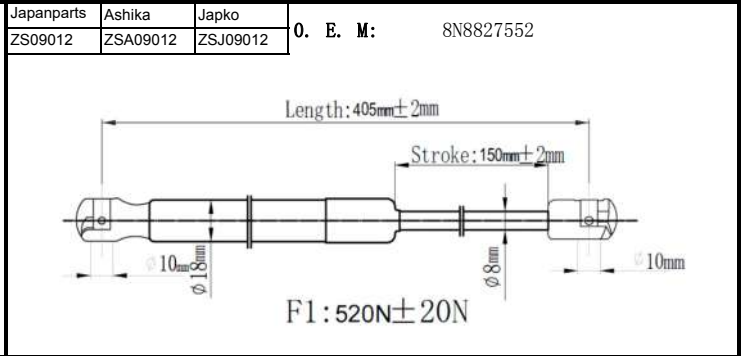
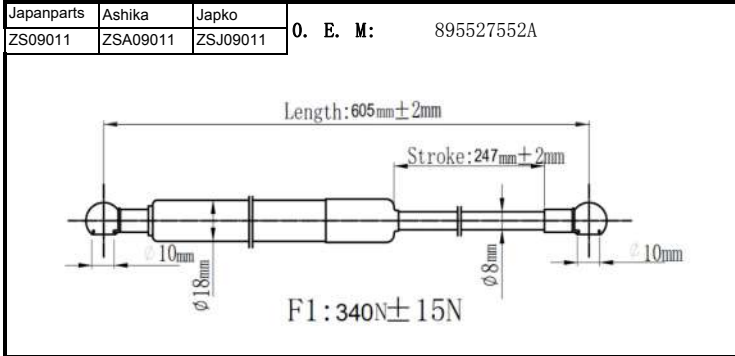
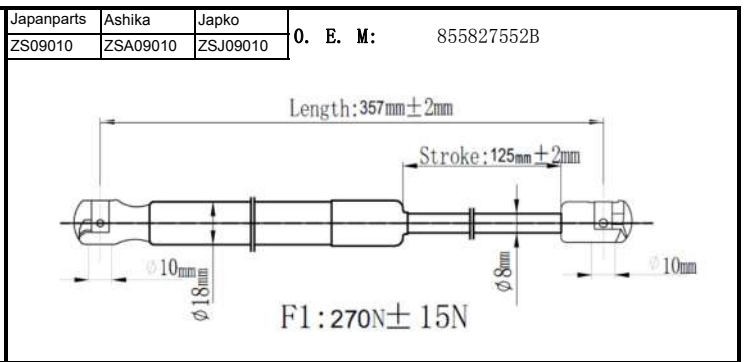
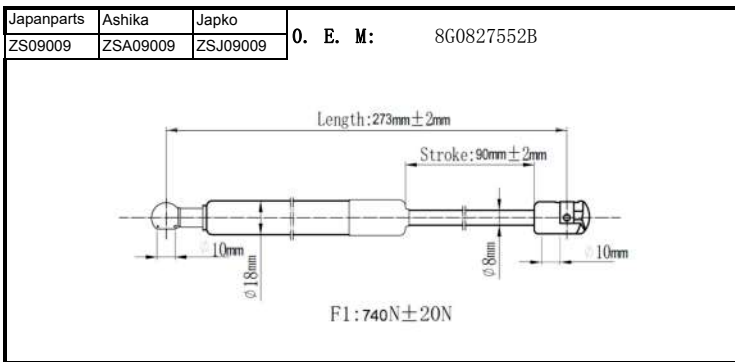

| | | |
|------------|----------|----------|
| Japanparts | Ashika | Japko |
| ZS09021 | ZSA09021 | ZSJ09021 |

O. E. M.: 4A9827552

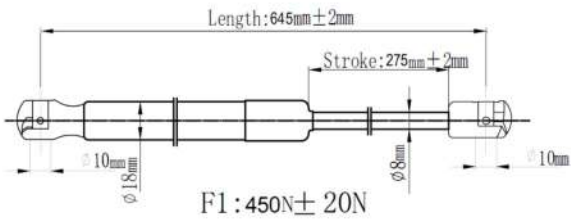

| | | |
|------------|----------|----------|
| Japanparts | Ashika | Japko |
| ZS09022 | ZSA09022 | ZSJ09022 |

O. E. M.: 4B9827552A

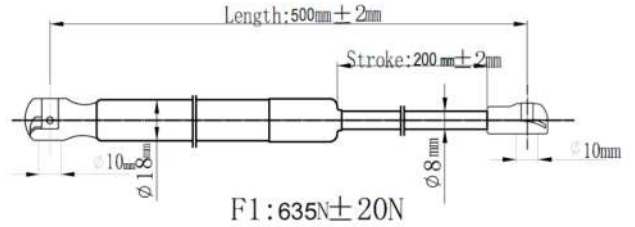

| | | |
|------------|----------|----------|
| Japanparts | Ashika | Japko |
| ZS09023 | ZSA09023 | ZSJ09023 |

O. E. M.: 4D0823359F

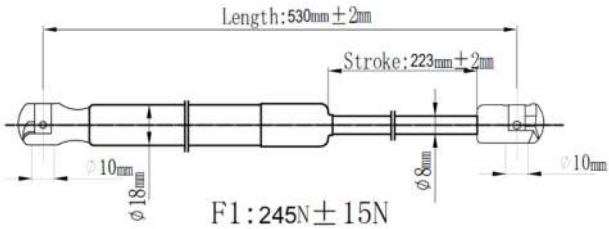

| | | |
|------------|----------|----------|
| Japanparts | Ashika | Japko |
| ZS09024 | ZSA09024 | ZSJ09024 |

O. E. M.: 4B9827552J

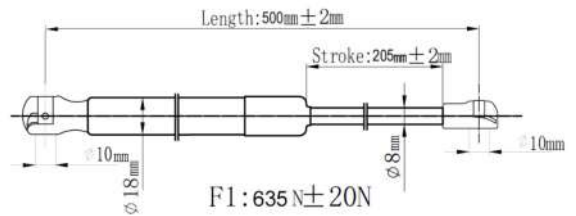

| | | |
|------------|----------|----------|
| Japanparts | Ashika | Japko |
| ZS09025 | ZSA09025 | ZSJ09025 |

O. E. M.: 4B5827552A

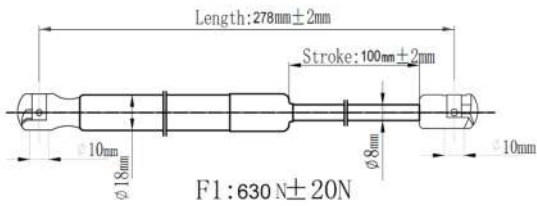

| | | |
|------------|----------|----------|
| Japanparts | Ashika | Japko |
| ZS09026 | ZSA09026 | ZSJ09026 |

O. E. M.: 443823359C

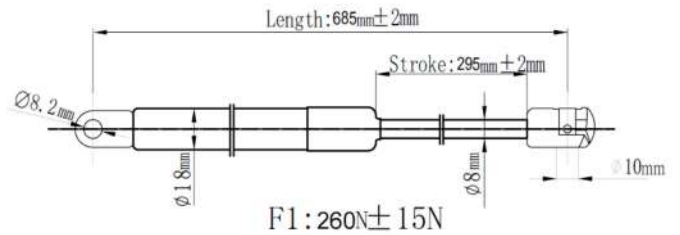

| | | |
|------------|----------|----------|
| Japanparts | Ashika | Japko |
| ZS09027 | ZSA09027 | ZSJ09027 |

O. E. M.: 4A0 823359

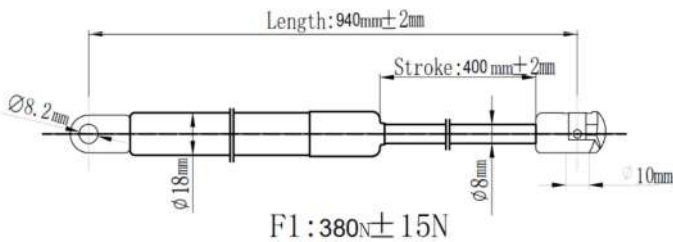

| | | |
|------------|----------|----------|
| Japanparts | Ashika | Japko |
| ZS09028 | ZSA09028 | ZSJ09028 |

O. E. M.: 445827551

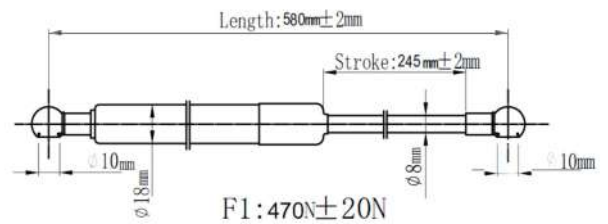

| | | |
|------------|----------|----------|
| Japanparts | Ashika | Japko |
| ZS09029 | ZSA09029 | ZSJ09029 |

O. E. M.: 8D9 827 552

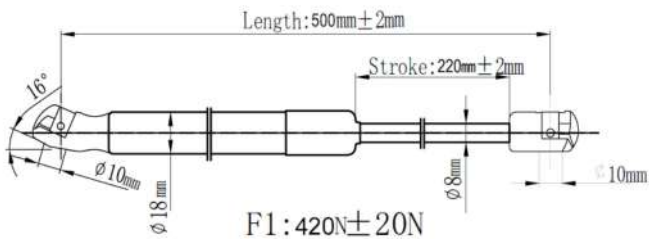

| | | |
|------------|----------|----------|
| Japanparts | Ashika | Japko |
| ZS09030 | ZSA09030 | ZSJ09030 |

O. E. M.: 8T0823359

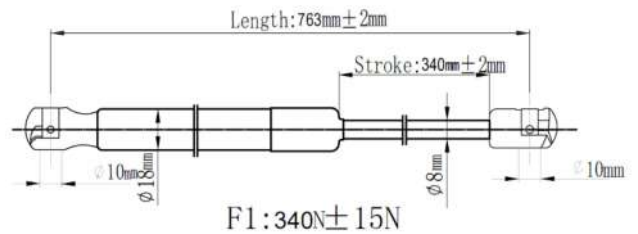

| | | |
|------------|----------|----------|
| Japanparts | Ashika | Japko |
| ZS09031 | ZSA09031 | ZSJ09031 |

O. E. M.: 4F0823359

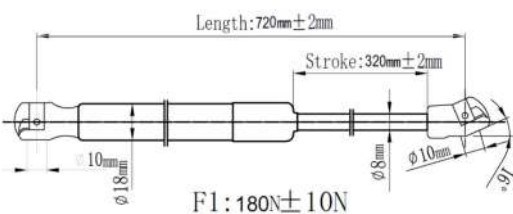

| | | |
|------------|----------|----------|
| Japanparts | Ashika | Japko |
| ZS09032 | ZSA09032 | ZSJ09032 |

O. E. M.: 4F5827552

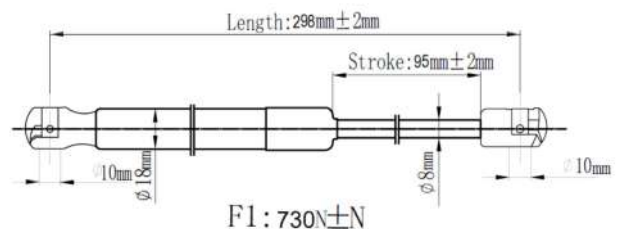

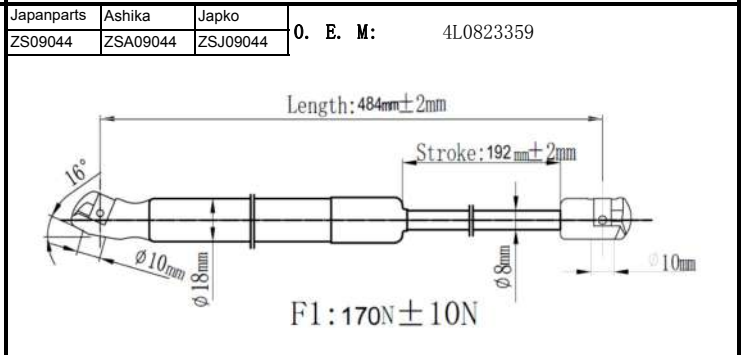
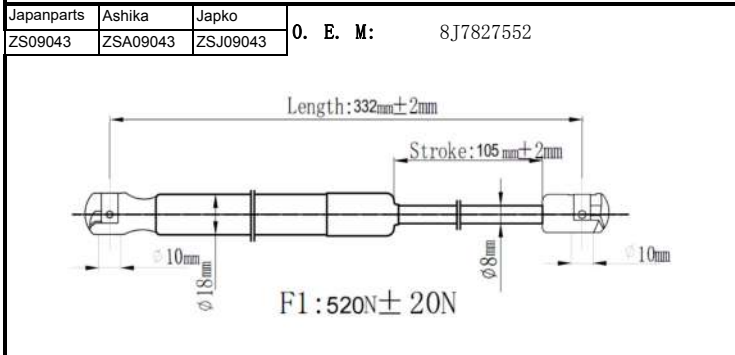
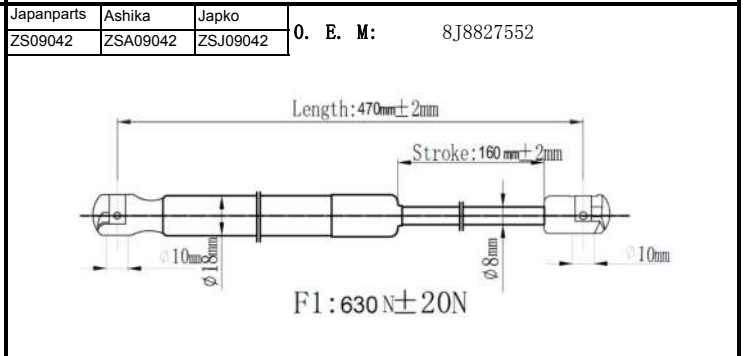
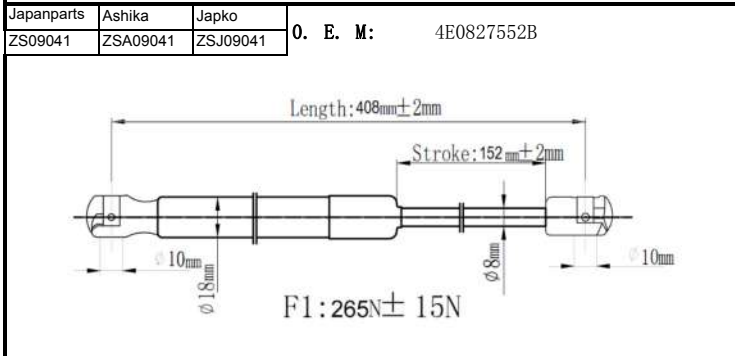
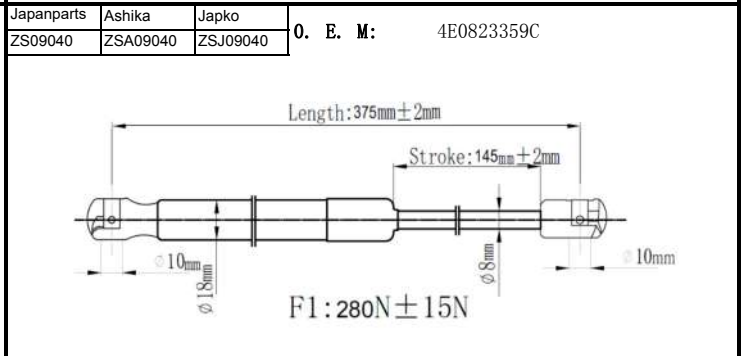
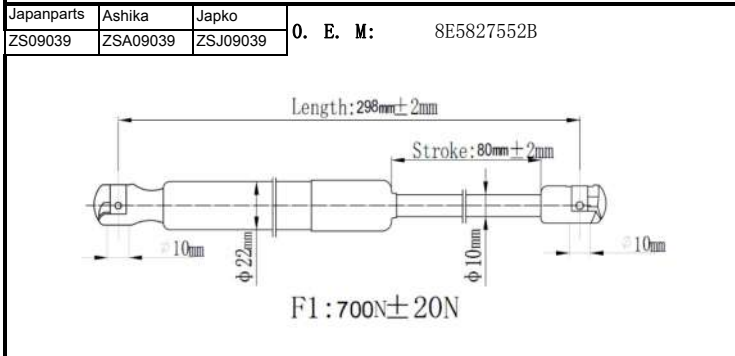
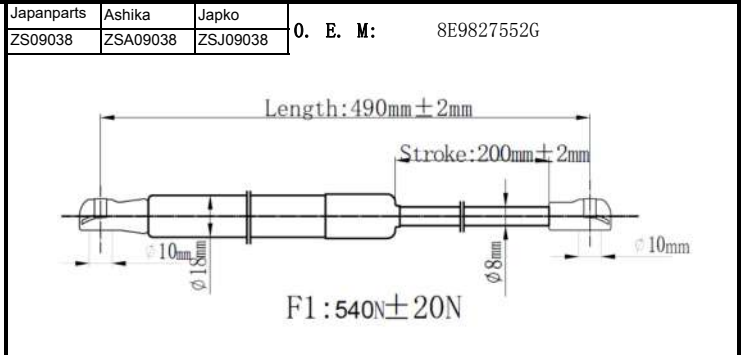
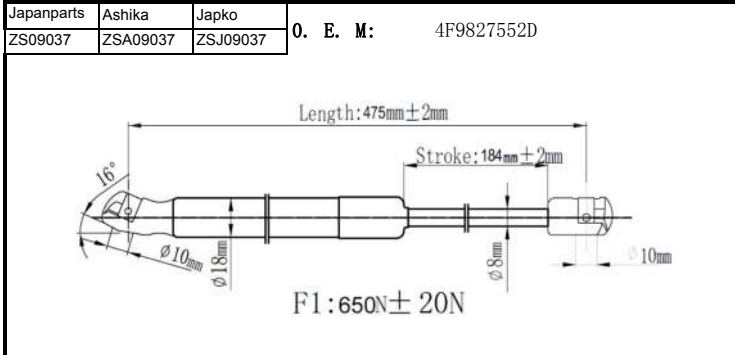
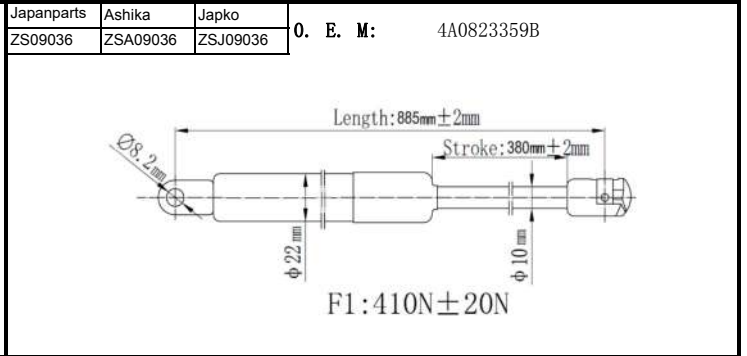
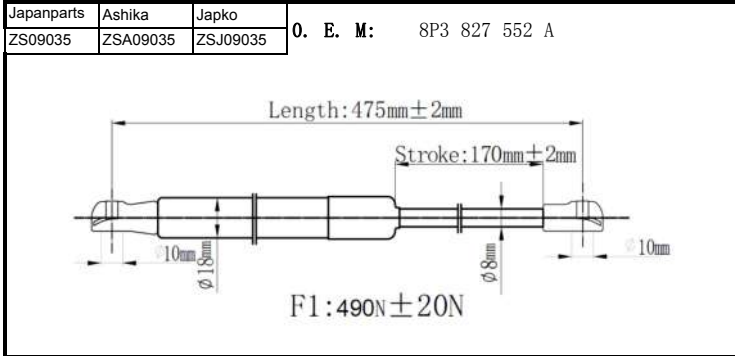
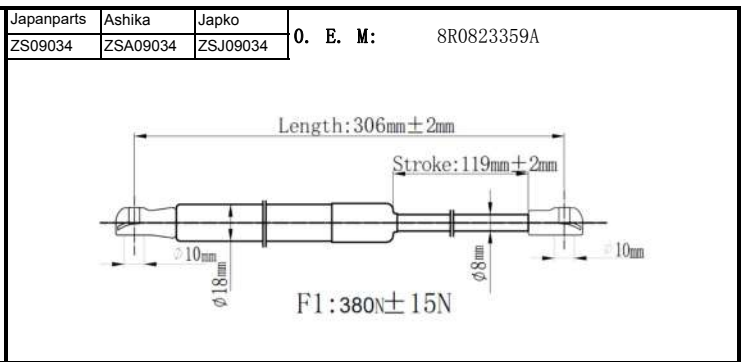
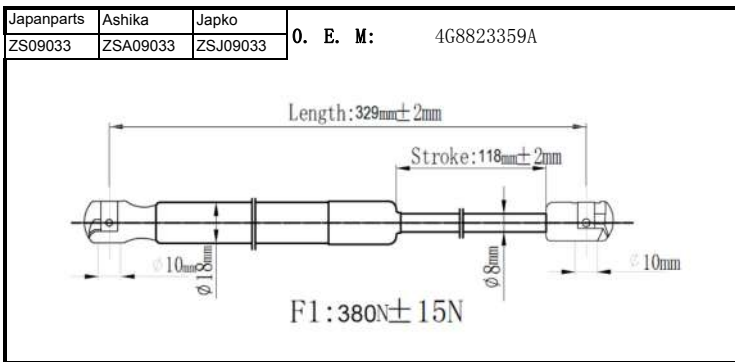

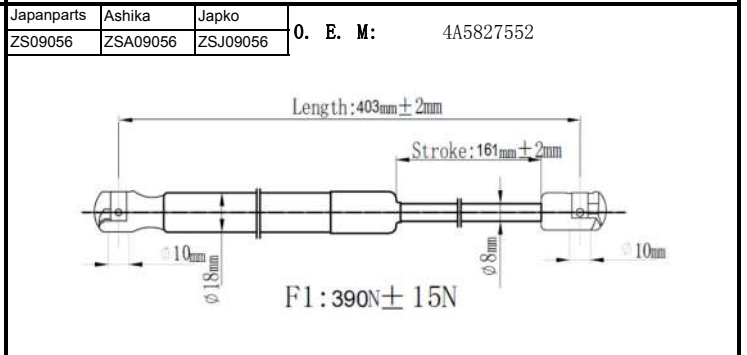
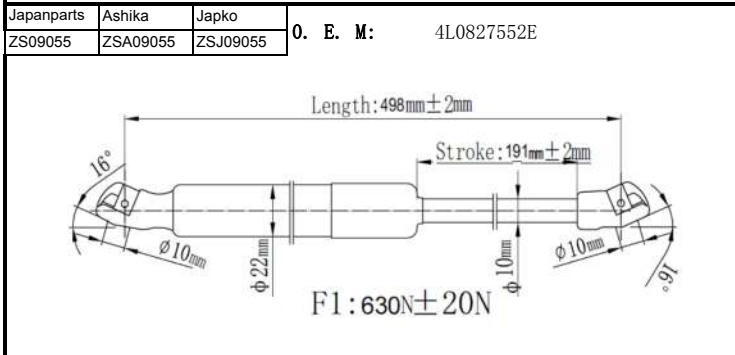
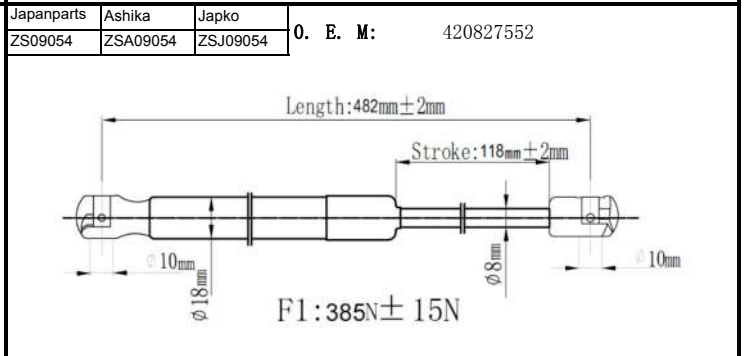
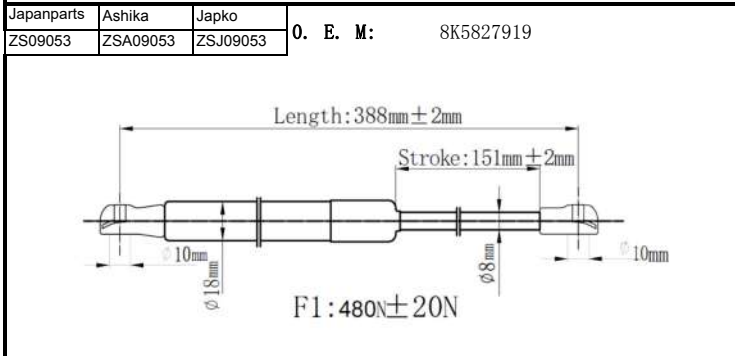
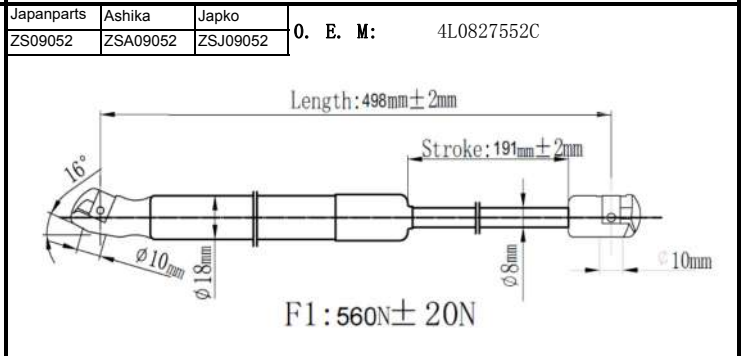
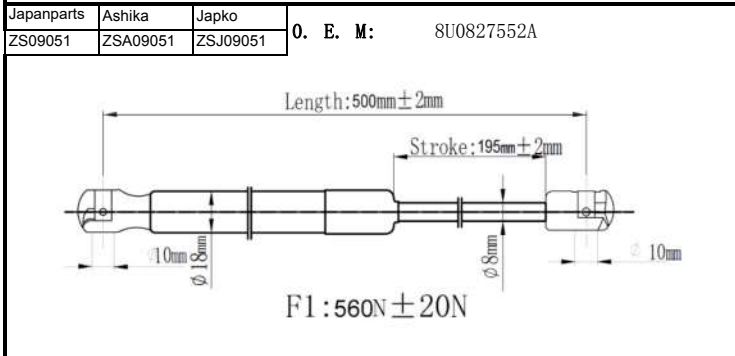
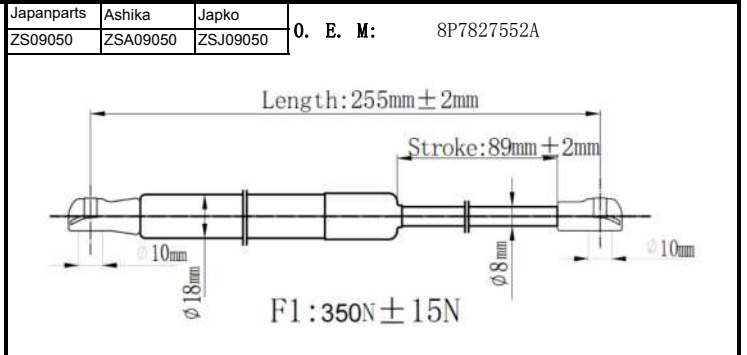
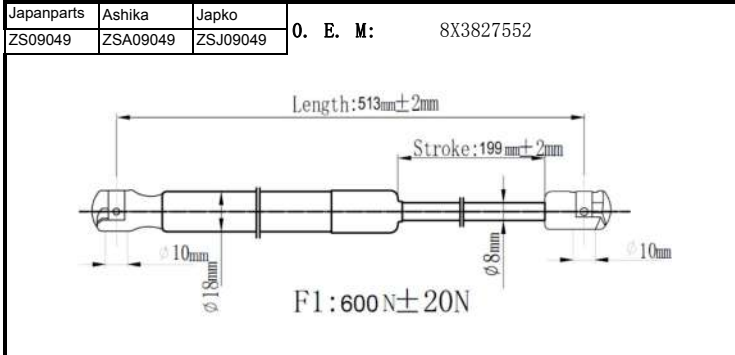
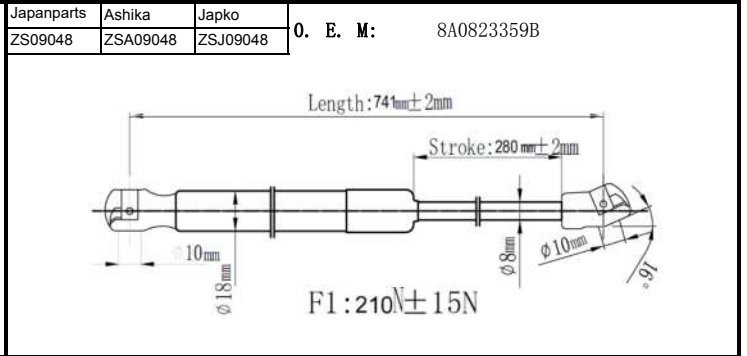
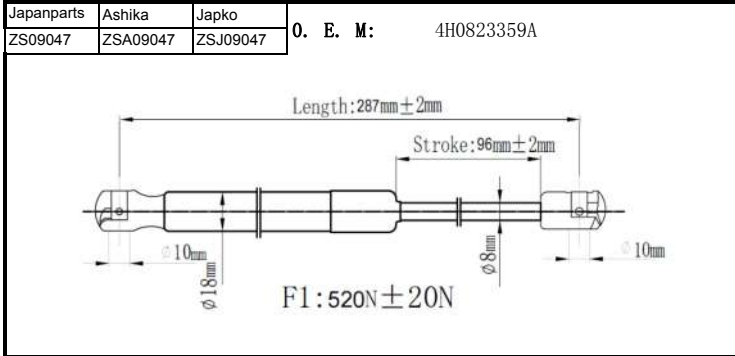
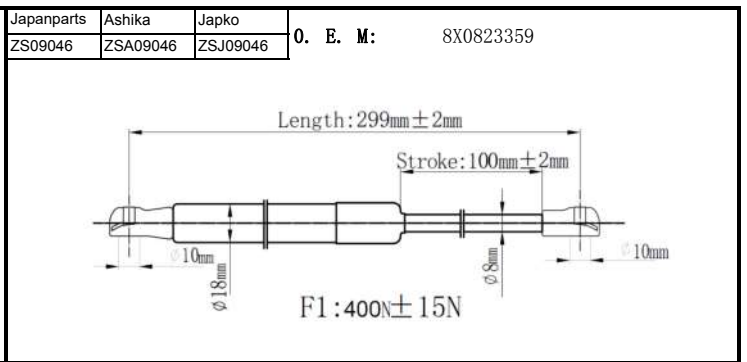
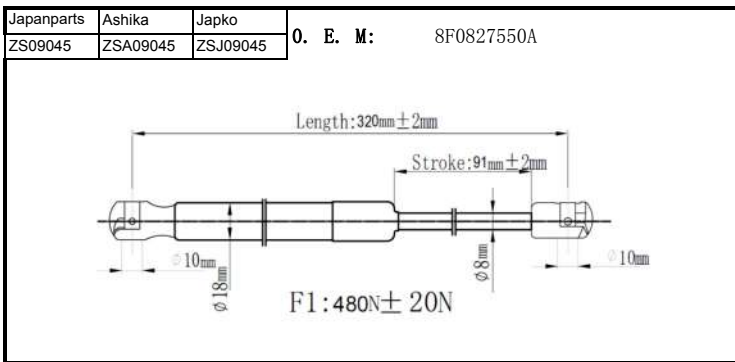

| | | |
|------------|----------|----------|
| Japanparts | Ashika | Japko |
| ZS09057 | ZSA09057 | ZSJ09057 |

O. E. M.: 857823359

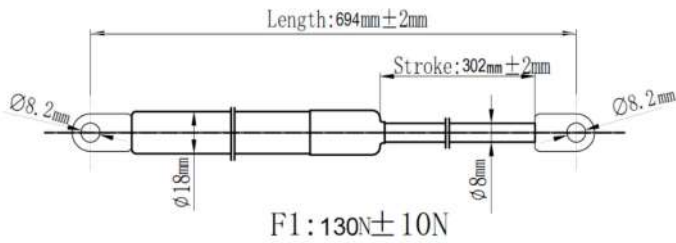

| | | |
|------------|----------|----------|
| Japanparts | Ashika | Japko |
| ZS09058 | ZSA09058 | ZSJ09058 |

O. E. M.: 4FO 827 552

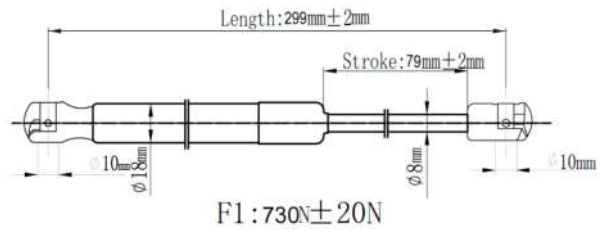

| | | |
|------------|----------|----------|
| Japanparts | Ashika | Japko |
| ZS09059 | ZSA09059 | ZSJ09059 |

O. E. M.: 4G9827552

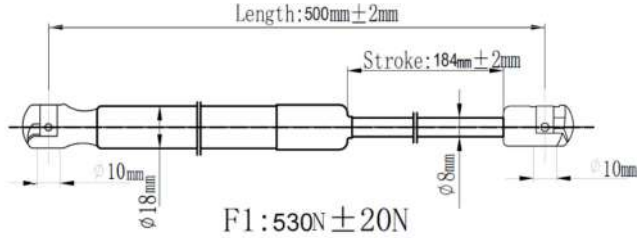

| | | |
|------------|----------|----------|
| Japanparts | Ashika | Japko |
| ZS09060 | ZSA09060 | ZSJ09060 |

O. E. M.: 4G9827552A

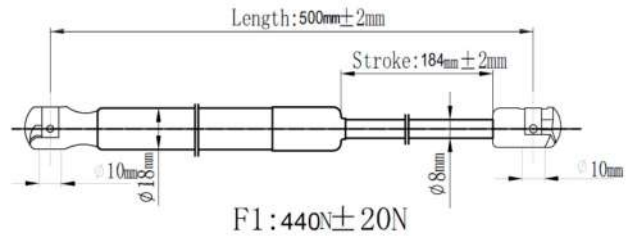

| | | |
|------------|----------|----------|
| Japanparts | Ashika | Japko |
| ZS09061 | ZSA09061 | ZSJ09061 |

O. E. M.: 8G0825373B

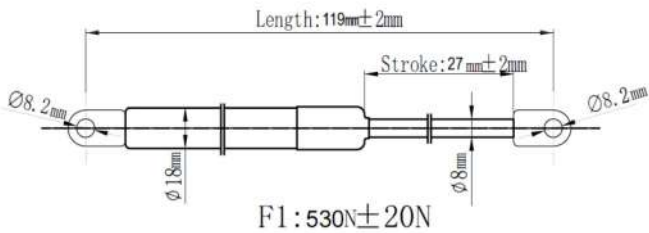

| | | |
|------------|----------|----------|
| Japanparts | Ashika | Japko |
| ZS09062 | ZSA09062 | ZSJ09062 |

O. E. M.: 8T8827552

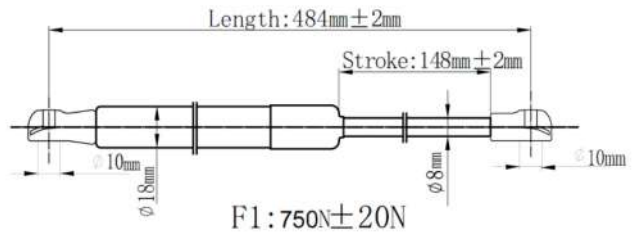

| | | |
|------------|----------|----------|
| Japanparts | Ashika | Japko |
| ZS09063 | ZSA09063 | ZSJ09063 |

O. E. M.: 8V3827552

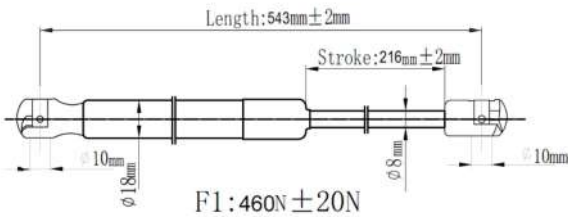

| | | |
|------------|----------|----------|
| Japanparts | Ashika | Japko |
| ZS09064 | ZSA09064 | ZSJ09064 |

O. E. M.: 8V4827552

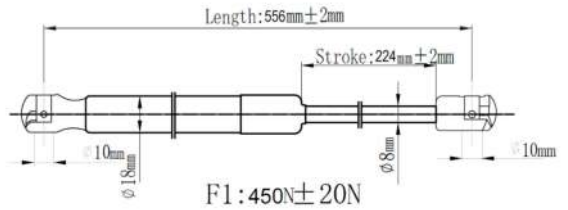

| | | |
|------------|----------|----------|
| Japanparts | Ashika | Japko |
| ZS09065 | ZSA09065 | ZSJ09065 |

O. E. M.: 8R0827552

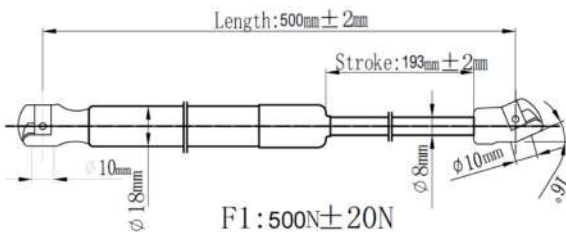

| | | |
|------------|----------|----------|
| Japanparts | Ashika | Japko |
| ZS09066 | ZSA09066 | ZSJ09066 |

O. E. M.: 4E0827551A

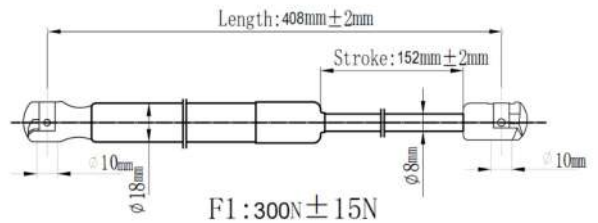

| | | |
|------------|----------|----------|
| Japanparts | Ashika | Japko |
| ZS09067 | ZSA09067 | ZSJ09067 |

O. E. M.: 8V0823359

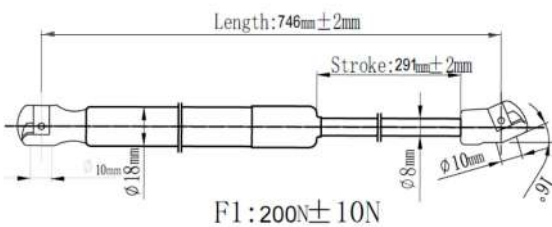

| | | |
|------------|----------|----------|
| Japanparts | Ashika | Japko |
| ZS09068 | ZSA09068 | ZSJ09068 |

O. E. M.: 4E0827551B

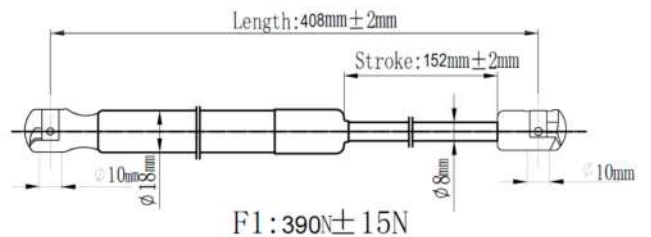

| | | |
|------------|----------|----------|
| Japanparts | Ashika | Japko |
| ZS09069 | ZSA09069 | ZSJ09069 |

O. E. M.: 8J0823359C

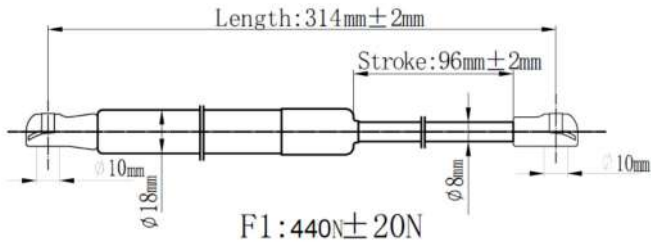

| | | |
|------------|----------|----------|
| Japanparts | Ashika | Japko |
| ZS09070 | ZSA09070 | ZSJ09070 |

O. E. M.: 8P4827552B

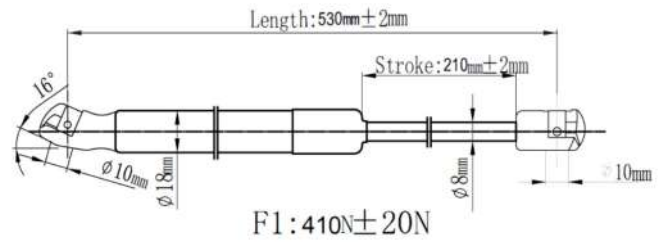

| | | |
|------------|----------|----------|
| Japanparts | Ashika | Japko |
| ZS09071 | ZSA09071 | ZSJ09071 |

O. E. M.: 8K9827552

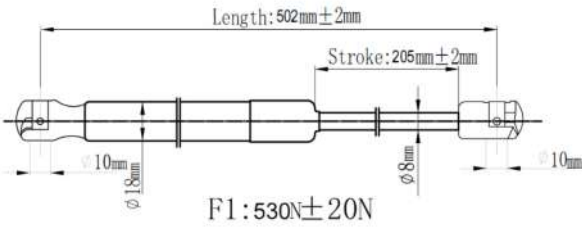

| | | |
|------------|----------|----------|
| Japanparts | Ashika | Japko |
| ZS09072 | ZSA09072 | ZSJ09072 |

O. E. M.: 8N7827552A

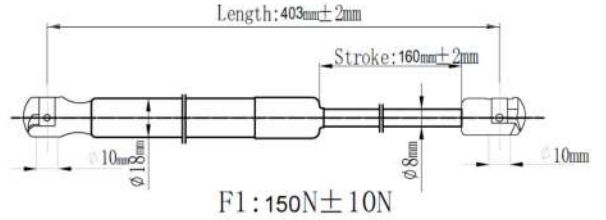

| | | |
|------------|----------|----------|
| Japanparts | Ashika | Japko |
| ZS09073 | ZSA09073 | ZSJ09073 |

O. E. M.: 8R0827552

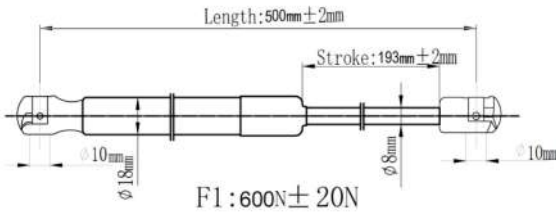

| | | |
|------------|----------|----------|
| Japanparts | Ashika | Japko |
| ZS09074 | ZSA09074 | ZSJ09074 |

O. E. M.: 893823360

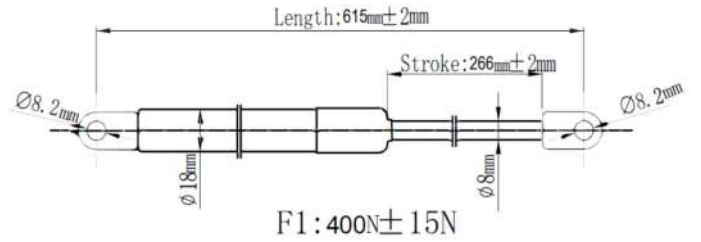

| | | |
|------------|----------|----------|
| Japanparts | Ashika | Japko |
| ZS09075 | ZSA09075 | ZSJ09075 |

O. E. M.: 4B9827552J

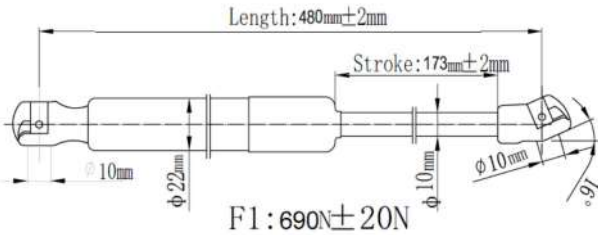

| | | |
|------------|----------|----------|
| Japanparts | Ashika | Japko |
| ZS09076 | ZSA09076 | ZSJ09076 |

O. E. M.: 8D0823354

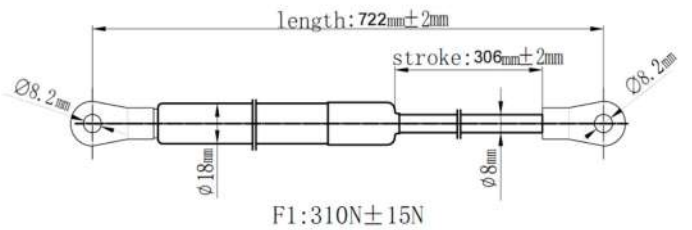

| | | |
|------------|----------|----------|
| Japanparts | Ashika | Japko |
| ZS09077 | ZSA09077 | ZSJ09077 |

O. E. M.: 8K9827552A

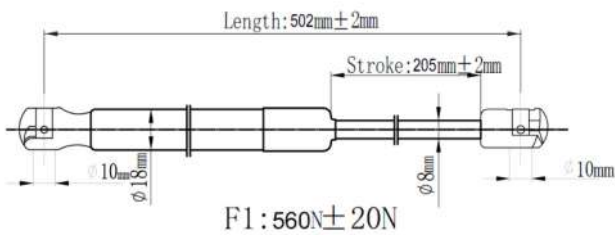

| | | |
|------------|----------|----------|
| Japanparts | Ashika | Japko |
| ZS09078 | ZSA09078 | ZSJ09078 |

O. E. M.: 4F9827552A

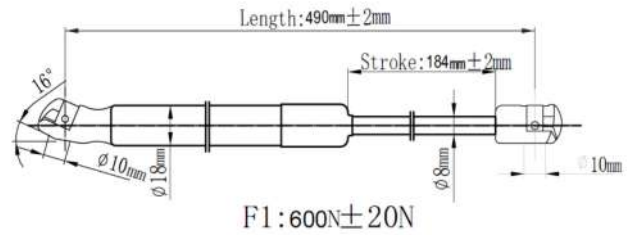

| | | |
|------------|----------|----------|
| Japanparts | Ashika | Japko |
| ZS09079 | ZSA09079 | ZSJ09079 |

O. E. M.: 427 827 552 A

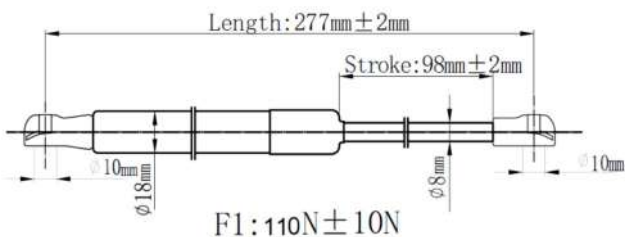

| | | |
|------------|----------|----------|
| Japanparts | Ashika | Japko |
| ZS09080 | ZSA09080 | ZSJ09080 |

O. E. M.: 8G0827552A

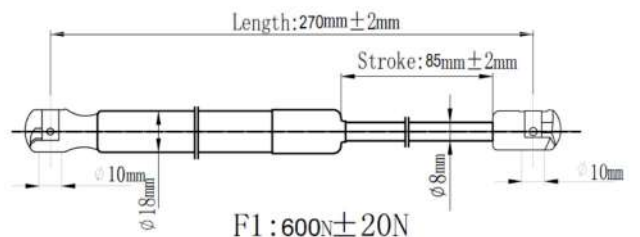

| | | |
|------------|----------|----------|
| Japanparts | Ashika | Japko |
| ZS09081 | ZSA09081 | ZSJ09081 |

O. E. M.: 8T0827919

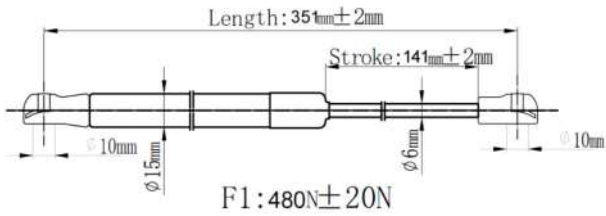

| | | |
|------------|----------|----------|
| Japanparts | Ashika | Japko |
| ZS09082 | ZSA09082 | ZSJ09082 |

O. E. M.: 861827550

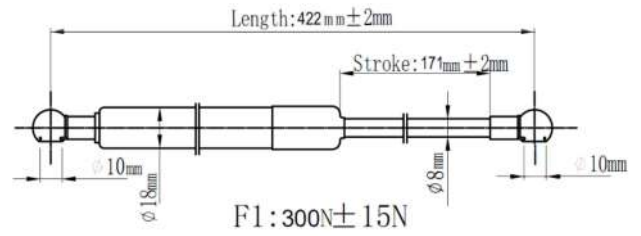

| | | |
|------------|----------|----------|
| Japanparts | Ashika | Japko |
| ZS09083 | ZSA09083 | ZSJ09083 |

O. E. M.: 420823359

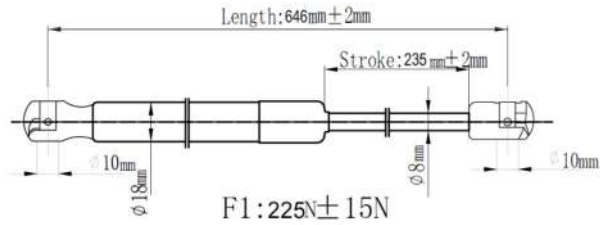

| | | |
|------------|----------|----------|
| Japanparts | Ashika | Japko |
| ZS09084 | ZSA09084 | ZSJ09084 |

O. E. M.: 8A9827552A

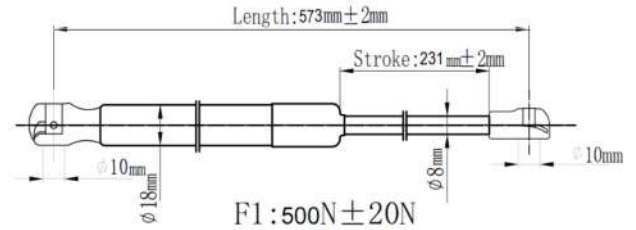

| | | |
|------------|----------|----------|
| Japanparts | Ashika | Japko |
| ZS09085 | ZSA09085 | ZSJ09085 |

O. E. M.: 13428038

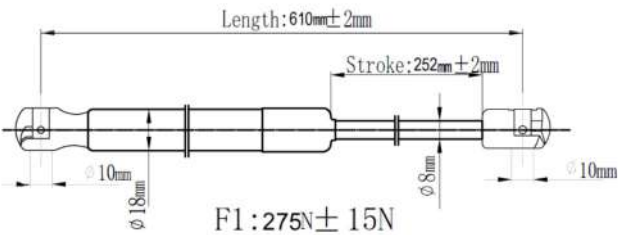

| | | |
|------------|----------|----------|
| Japanparts | Ashika | Japko |
| ZS09086 | ZSA09086 | ZSJ09086 |

O. E. M.: 95542338900

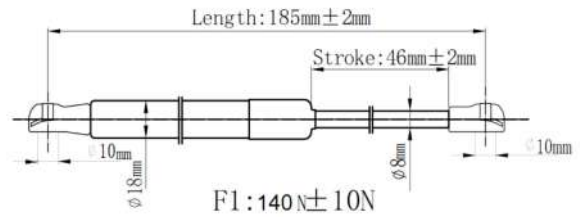

| | | |
|------------|----------|----------|
| Japanparts | Ashika | Japko |
| ZS09087 | ZSA09087 | ZSJ09087 |

O. E. M.: 6X0827550

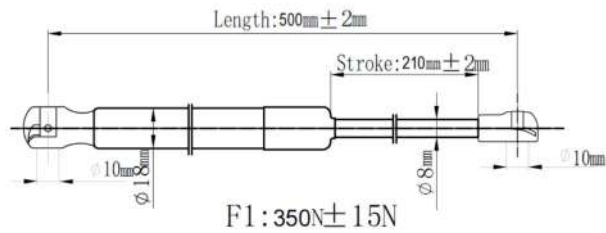

| | | |
|------------|----------|----------|
| Japanparts | Ashika | Japko |
| ZS09088 | ZSA09088 | ZSJ09088 |

O. E. M.: 3B5827550G

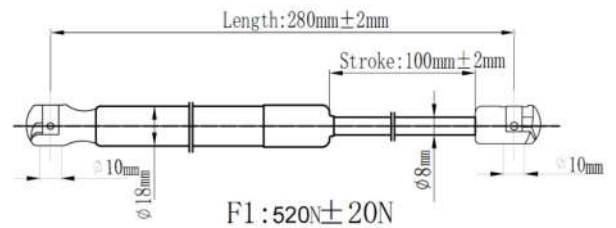

| | | |
|------------|----------|----------|
| Japanparts | Ashika | Japko |
| ZS09089 | ZSA09089 | ZSJ09089 |

O. E. M.: 8E9827552E

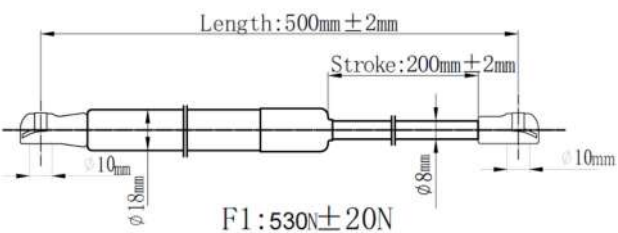

| | | |
|------------|----------|----------|
| Japanparts | Ashika | Japko |
| ZS09090 | ZSA09090 | ZSJ09090 |

O. E. M.: 3B0823239A

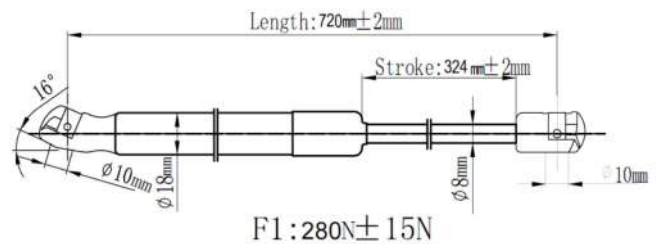

| | | |
|------------|----------|----------|
| Japanparts | Ashika | Japko |
| ZS09091 | ZSA09091 | ZSJ09091 |

O. E. M.: 408957

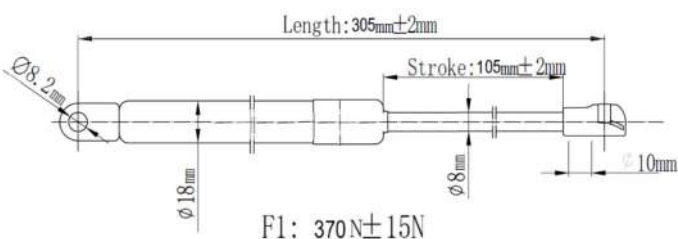

| | | |
|------------|----------|----------|
| Japanparts | Ashika | Japko |
| ZS09092 | ZSA09092 | ZSJ09092 |

O. E. M.: 92851113903

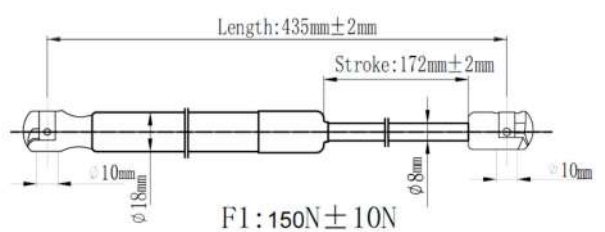

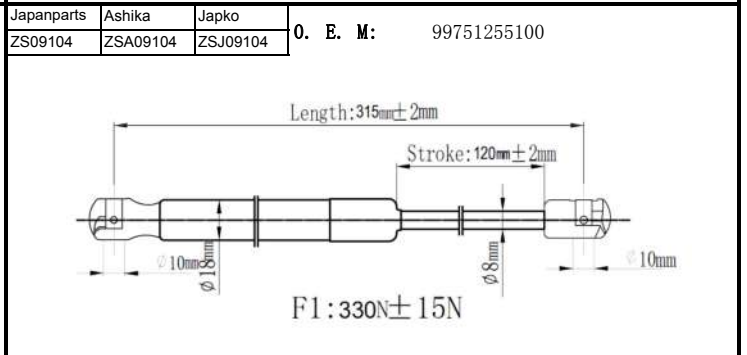
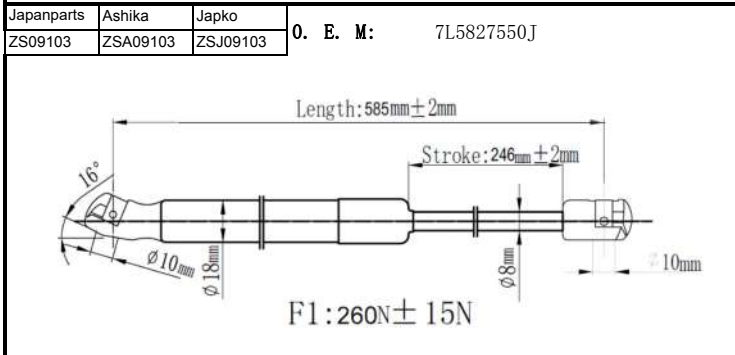
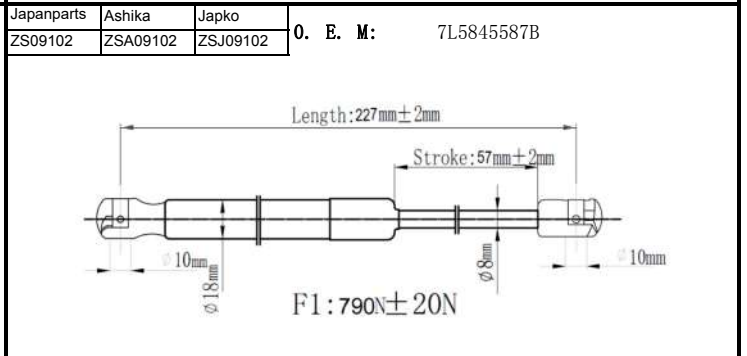
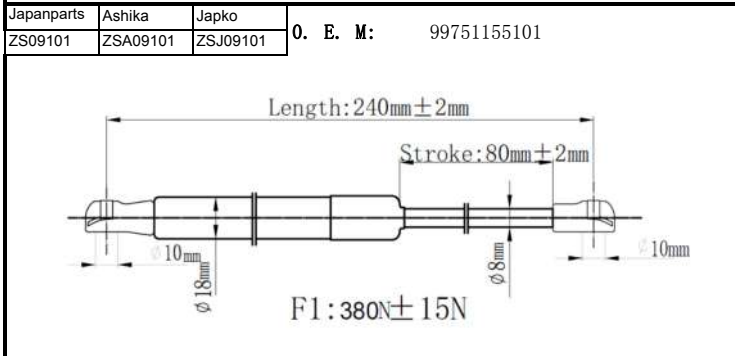
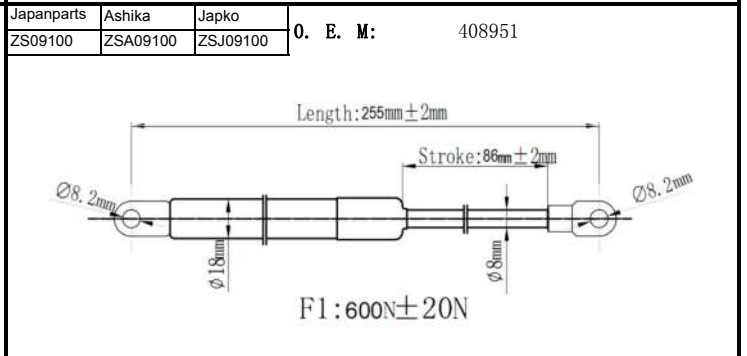
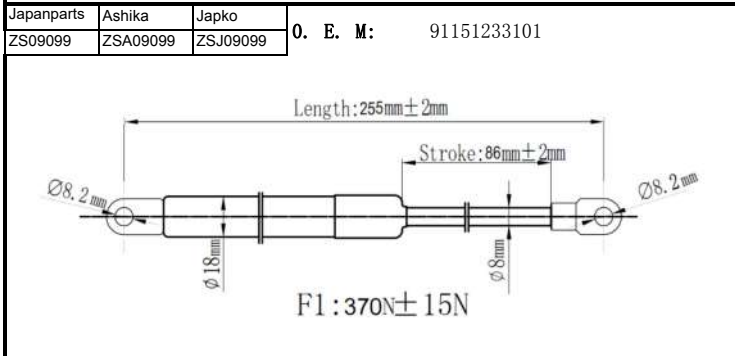
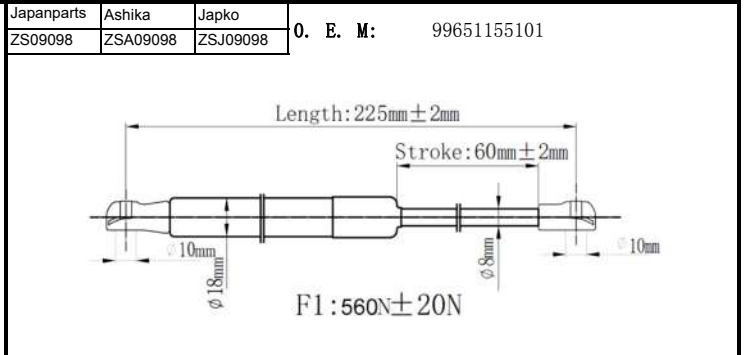
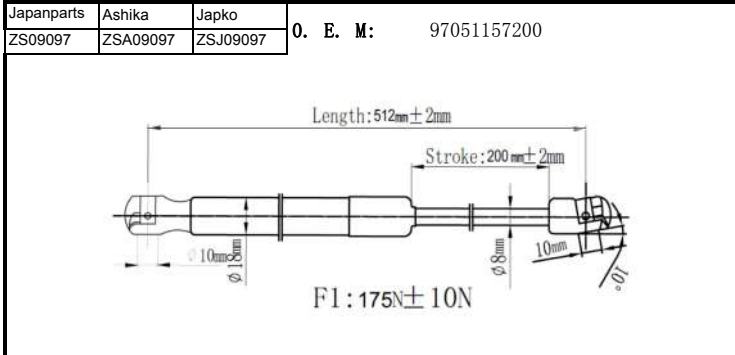
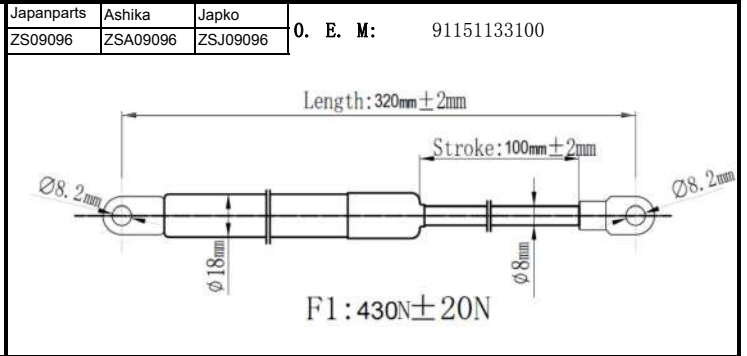
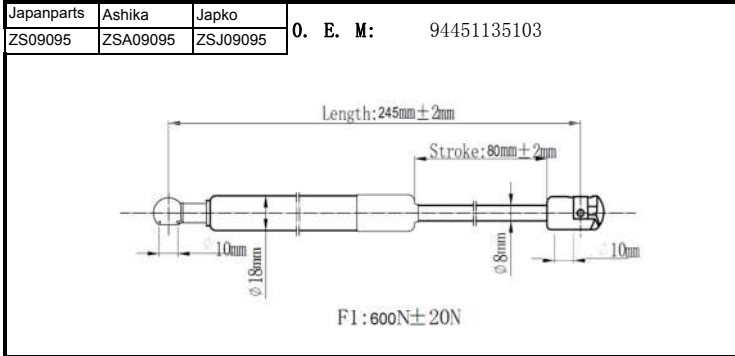
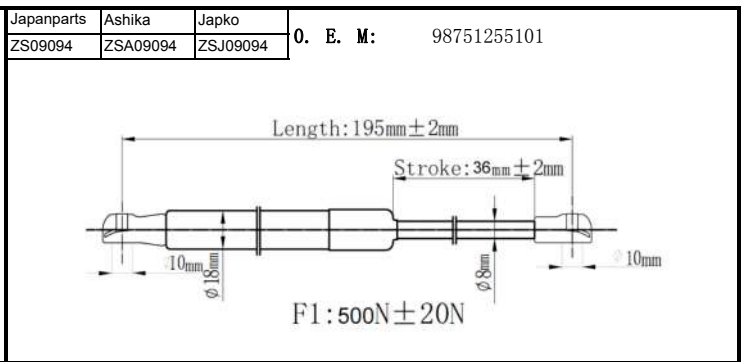
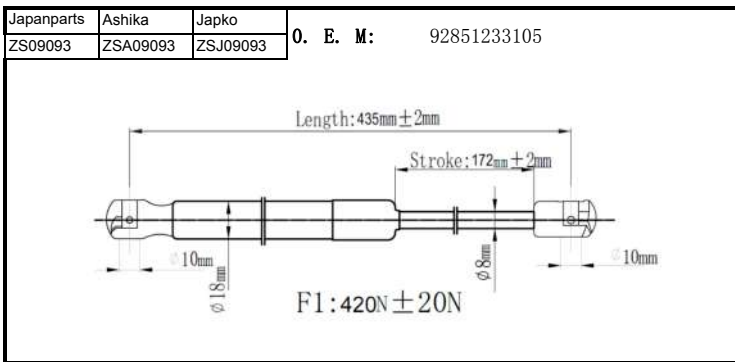

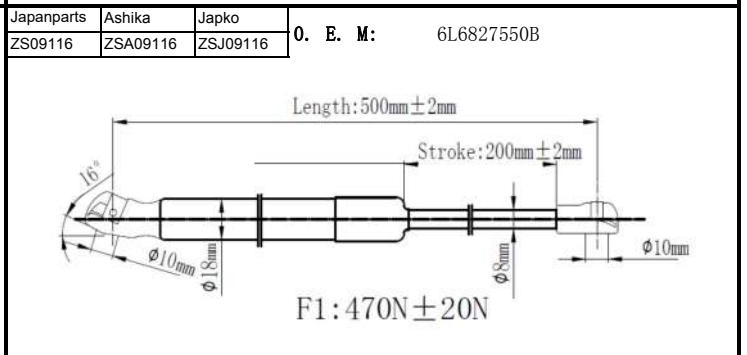
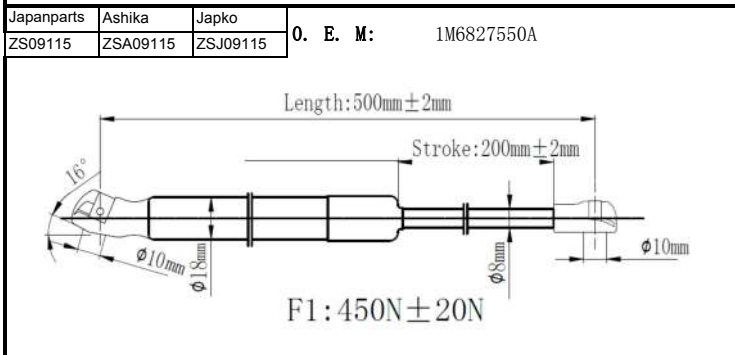
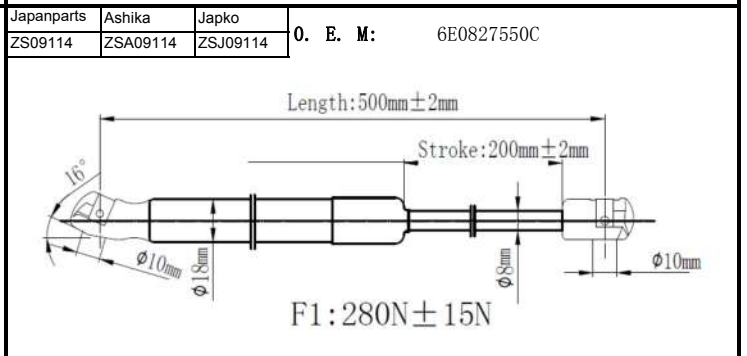
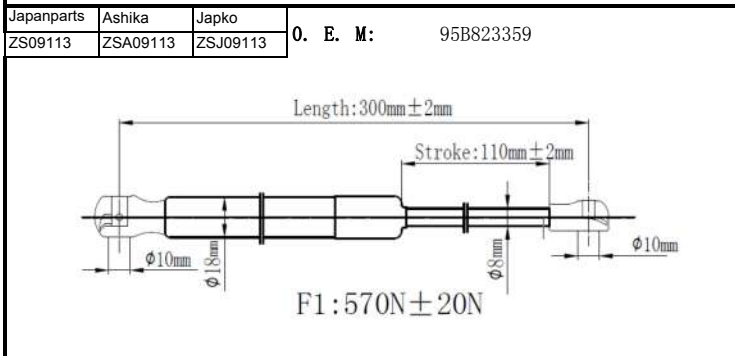
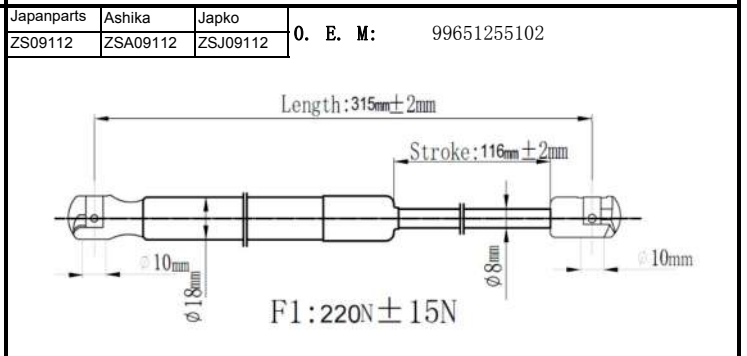
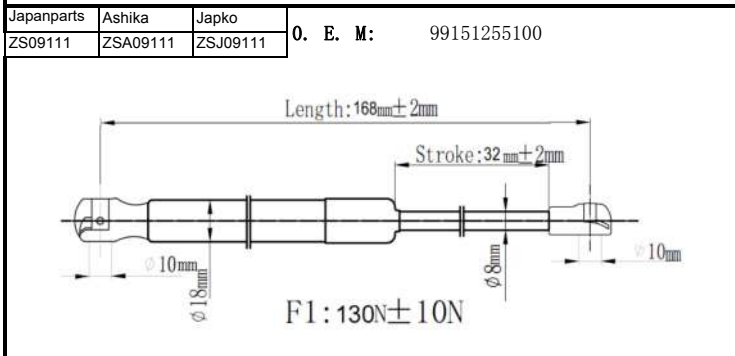
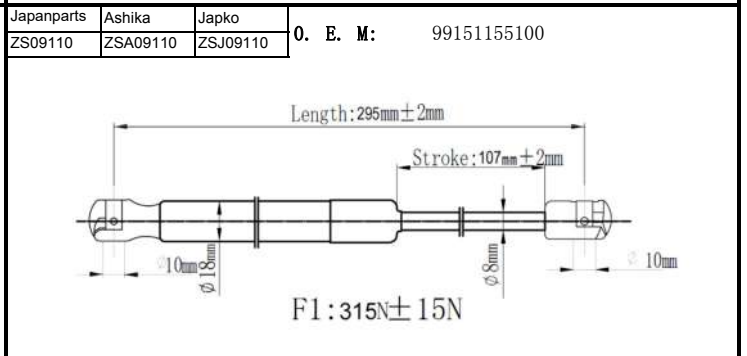
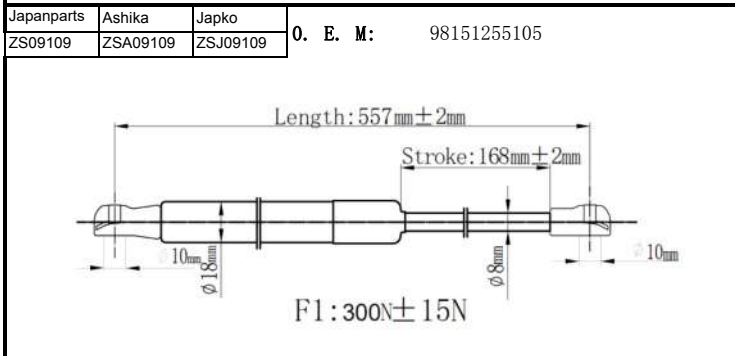
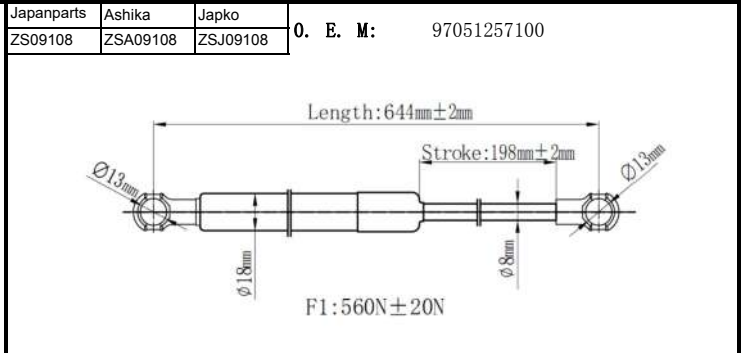
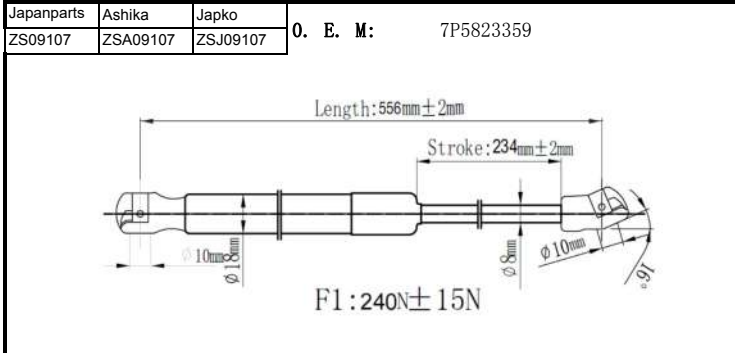
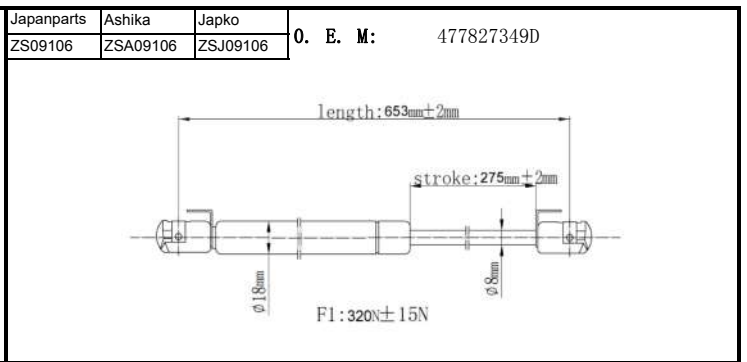
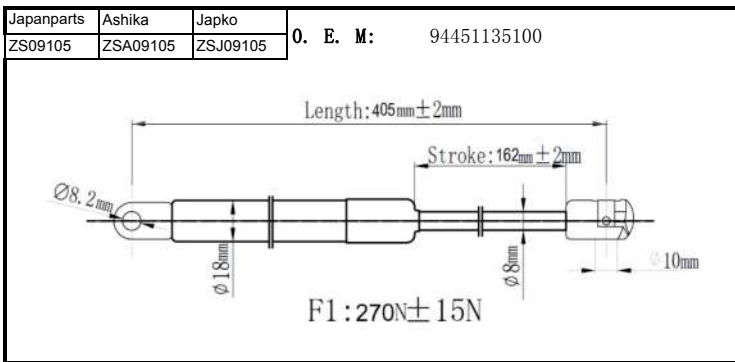

| | | |
|------------|----------|----------|
| Japanparts | Ashika | Japko |
| ZS09117 | ZSA09117 | ZSJ09117 |

O. E. M.: 1M5827550B

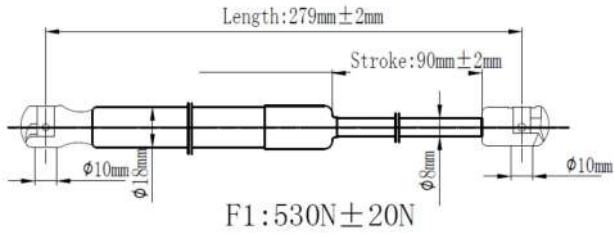

| | | |
|------------|----------|----------|
| Japanparts | Ashika | Japko |
| ZS09118 | ZSA09118 | ZSJ09118 |

O. E. M.: 3R9827550

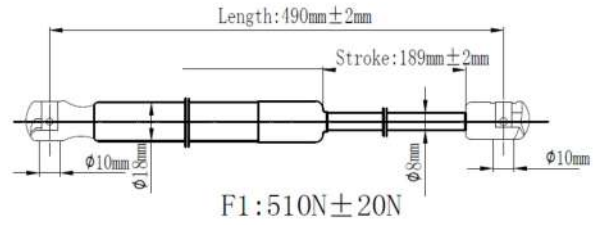

| | | |
|------------|----------|----------|
| Japanparts | Ashika | Japko |
| ZS09119 | ZSA09119 | ZSJ09119 |

O. E. M.: 5P5827550A

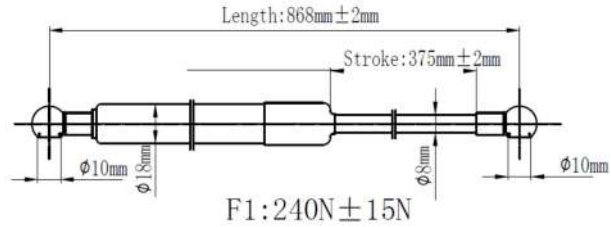

| | | |
|------------|----------|----------|
| Japanparts | Ashika | Japko |
| ZS09120 | ZSA09120 | ZSJ09120 |

O. E. M.: 1M0823359A

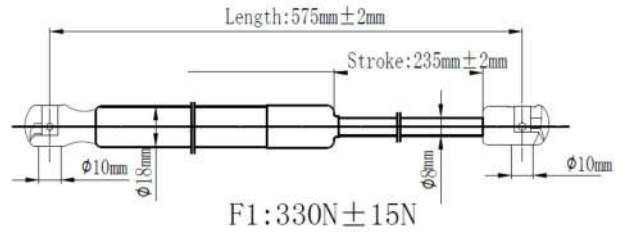

| | | |
|------------|----------|----------|
| Japanparts | Ashika | Japko |
| ZS09121 | ZSA09121 | ZSJ09121 |

O. E. M.: 6L5827550B

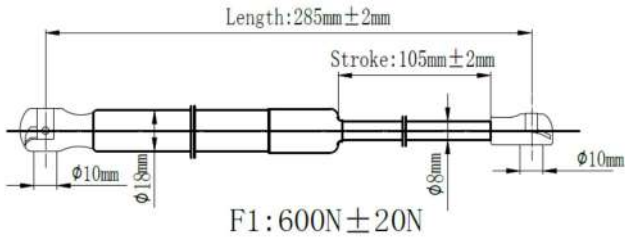

| | | |
|------------|----------|----------|
| Japanparts | Ashika | Japko |
| ZS09122 | ZSA09122 | ZSJ09122 |

O. E. M.: 6J3827550

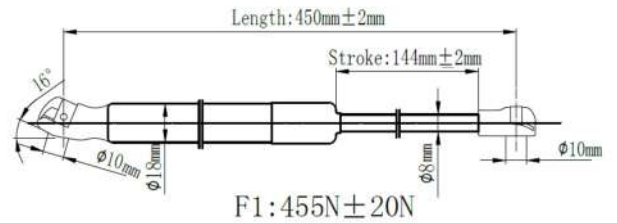

| | | |
|------------|----------|----------|
| Japanparts | Ashika | Japko |
| ZS09123 | ZSA09123 | ZSJ09123 |

O. E. M.: 6J4827550B

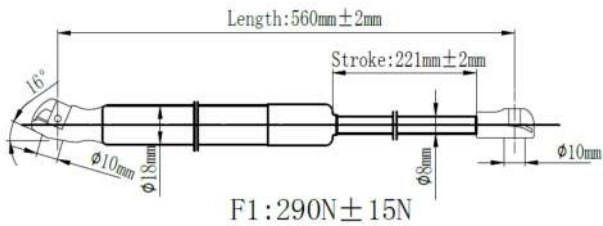

| | | |
|------------|----------|----------|
| Japanparts | Ashika | Japko |
| ZS09124 | ZSA09124 | ZSJ09124 |

O. E. M.: 5F4827550A

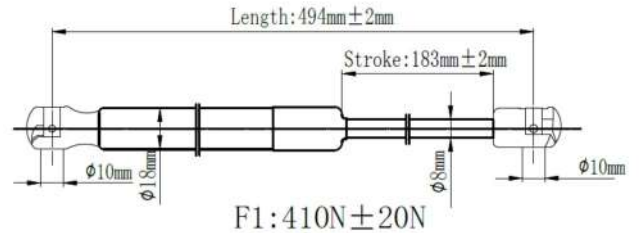

| | | |
|------------|----------|----------|
| Japanparts | Ashika | Japko |
| ZS09125 | ZSA09125 | ZSJ09125 |

O. E. M.: 5F9827550A

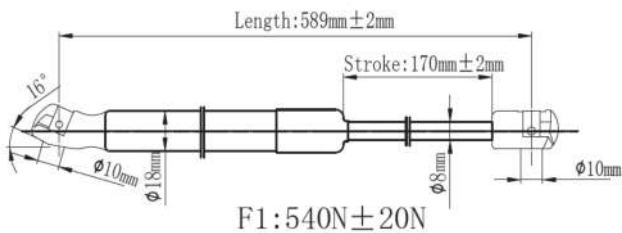

| | | |
|------------|----------|----------|
| Japanparts | Ashika | Japko |
| ZS09126 | ZSA09126 | ZSJ09126 |

O. E. M.: 6J8827550B

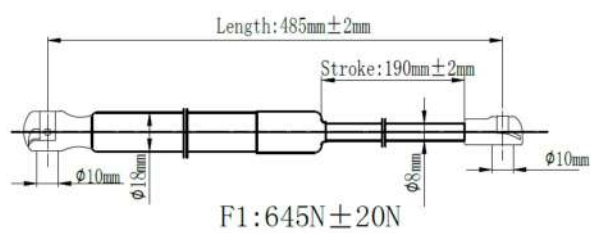

| | | |
|------------|----------|----------|
| Japanparts | Ashika | Japko |
| ZS09127 | ZSA09127 | ZSJ09127 |

O. E. M.: 1L0827550

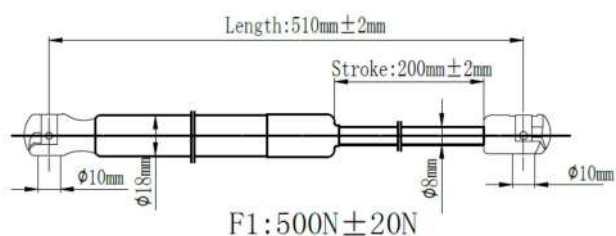

| | | |
|------------|----------|----------|
| Japanparts | Ashika | Japko |
| ZS09128 | ZSA09128 | ZSJ09128 |

O. E. M.: SE021526200A

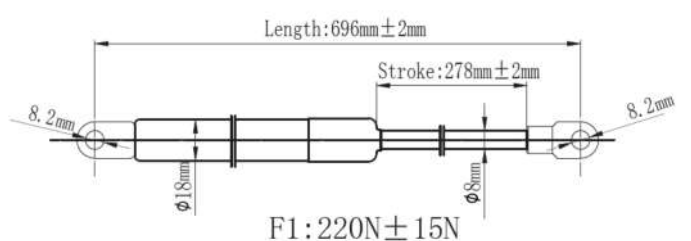

| | | |
|------------|----------|----------|
| Japanparts | Ashika | Japko |
| ZS09129 | ZSA09129 | ZSJ09129 |

O. E. M.: 6K6827550

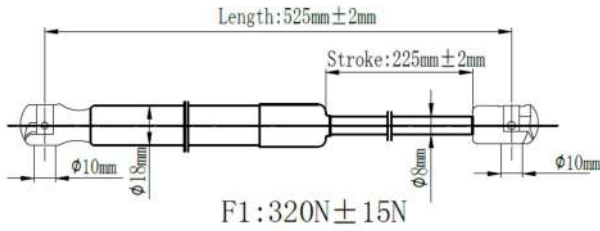

| | | |
|------------|----------|----------|
| Japanparts | Ashika | Japko |
| ZS09130 | ZSA09130 | ZSJ09130 |

O. E. M.: 5F3827550A

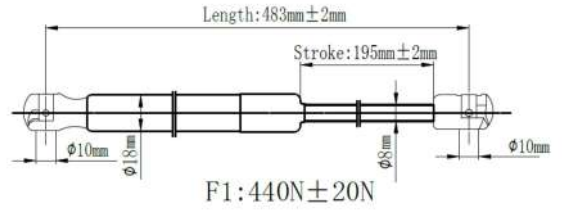

| | | |
|------------|----------|----------|
| Japanparts | Ashika | Japko |
| ZS09131 | ZSA09131 | ZSJ09131 |

O. E. M.: SE023529200A

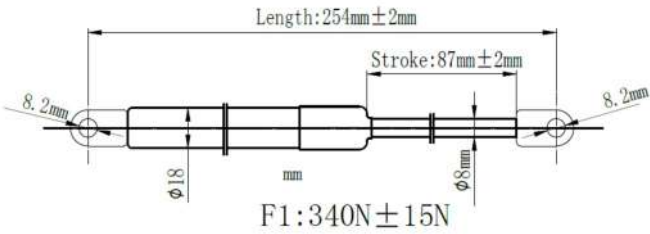

| | | |
|------------|----------|----------|
| Japanparts | Ashika | Japko |
| ZS09132 | ZSA09132 | ZSJ09132 |

O. E. M.: 1ST827550A

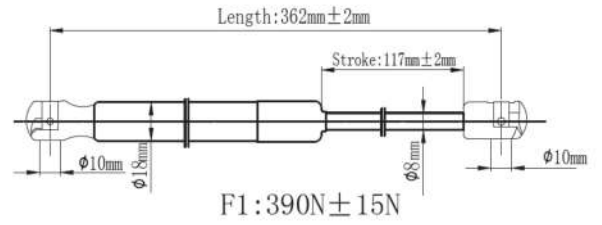

| | | |
|------------|----------|----------|
| Japanparts | Ashika | Japko |
| ZS09133 | ZSA09133 | ZSJ09133 |

O. E. M.: 6K5827550

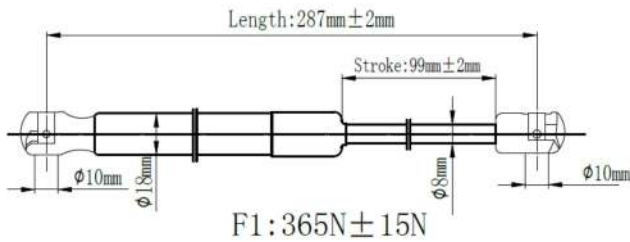

| | | |
|------------|----------|----------|
| Japanparts | Ashika | Japko |
| ZS09134 | ZSA09134 | ZSJ09134 |

O. E. M.: 5P0827550A

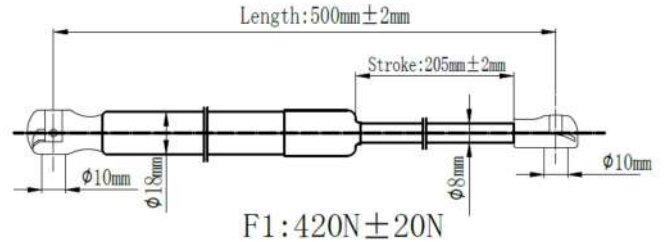

| | | |
|------------|----------|----------|
| Japanparts | Ashika | Japko |
| ZS09135 | ZSA09135 | ZSJ09135 |

O. E. M.: 7M0823359G

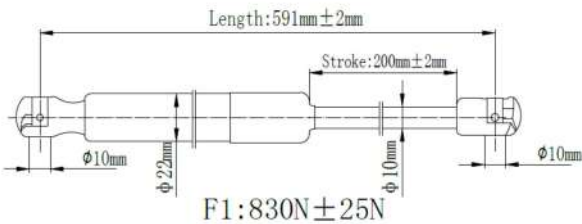

| | | |
|------------|----------|----------|
| Japanparts | Ashika | Japko |
| ZS09136 | ZSA09136 | ZSJ09136 |

O. E. M.: 7N0827550

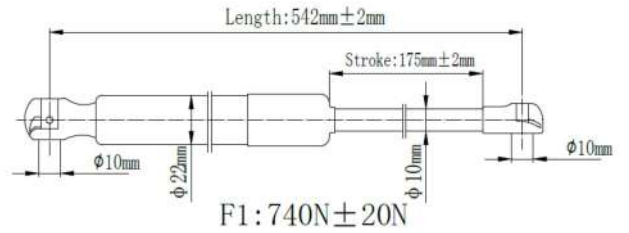

| | | |
|------------|----------|----------|
| Japanparts | Ashika | Japko |
| ZS09137 | ZSA09137 | ZSJ09137 |

O. E. M.: 7N0823359

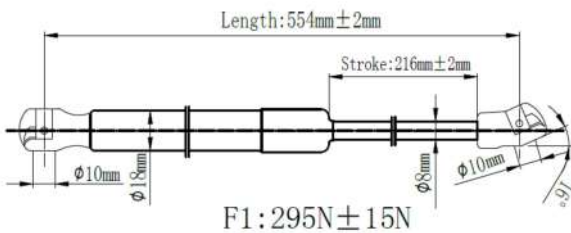

| | | |
|------------|----------|----------|
| Japanparts | Ashika | Japko |
| ZS09138 | ZSA09138 | ZSJ09138 |

O. E. M.: 6Y0827550A

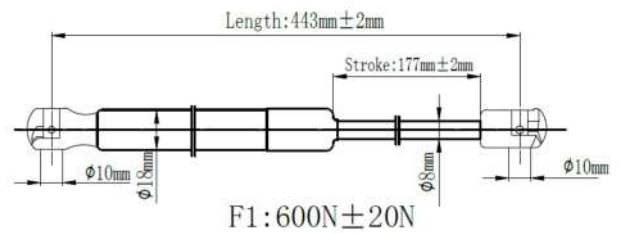

| | | |
|------------|----------|----------|
| Japanparts | Ashika | Japko |
| ZS09139 | ZSA09139 | ZSJ09139 |

O. E. M.: 115740263

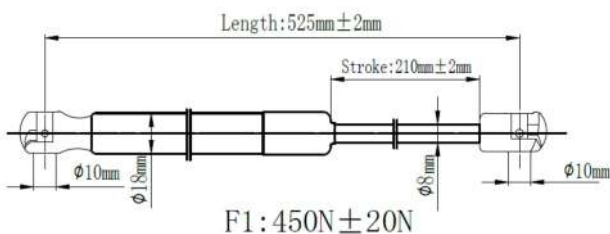

| | | |
|------------|----------|----------|
| Japanparts | Ashika | Japko |
| ZS09140 | ZSA09140 | ZSJ09140 |

O. E. M.: 1U9827550A

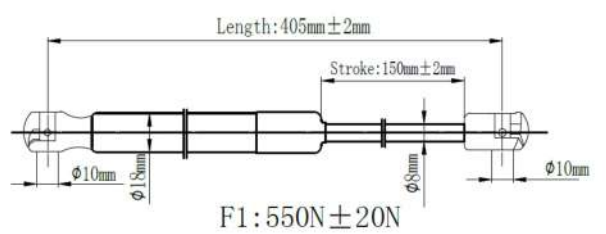

| | | |
|------------|----------|----------|
| Japanparts | Ashika | Japko |
| ZS09141 | ZSA09141 | ZSJ09141 |

O. E. M.: 3U0823359

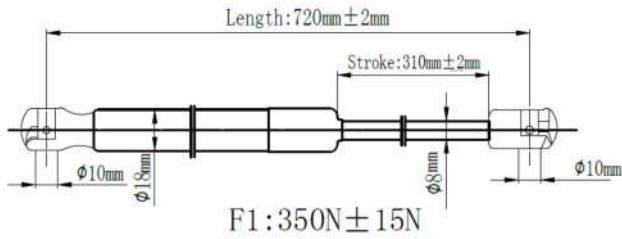

| | | |
|------------|----------|----------|
| Japanparts | Ashika | Japko |
| ZS09142 | ZSA09142 | ZSJ09142 |

O. E. M.: 1Z9827550

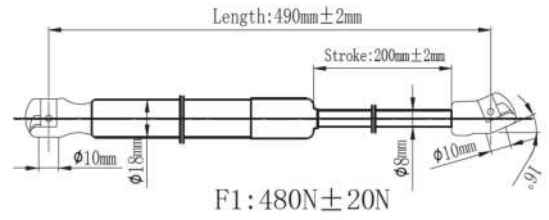

| | | |
|------------|----------|----------|
| Japanparts | Ashika | Japko |
| ZS09143 | ZSA09143 | ZSJ09143 |

O. E. M.: 5E5827550

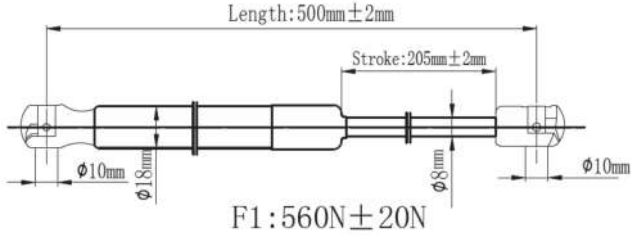

| | | |
|------------|----------|----------|
| Japanparts | Ashika | Japko |
| ZS09144 | ZSA09144 | ZSJ09144 |

O. E. M.: 5J7827550

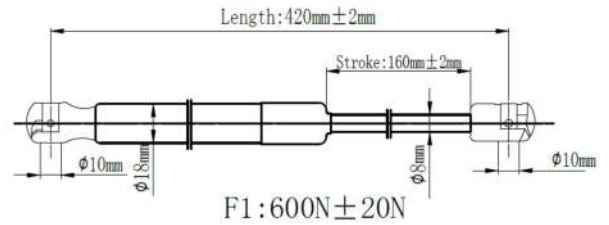

| | | |
|------------|----------|----------|
| Japanparts | Ashika | Japko |
| ZS09145 | ZSA09145 | ZSJ09145 |

O. E. M.:

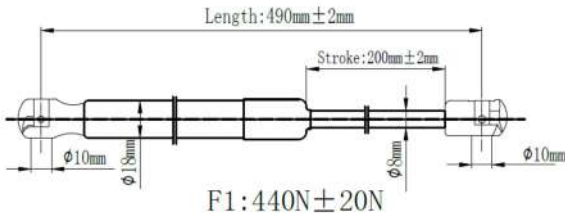

| | | |
|------------|----------|----------|
| Japanparts | Ashika | Japko |
| ZS09146 | ZSA09146 | ZSJ09146 |

O. E. M.: 1U6827550G

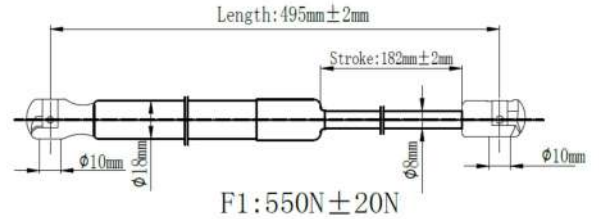

| | | |
|------------|----------|----------|
| Japanparts | Ashika | Japko |
| ZS09147 | ZSA09147 | ZSJ09147 |

O. E. M.: 3T0823359

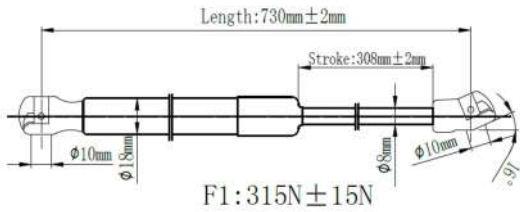

| | | |
|------------|----------|----------|
| Japanparts | Ashika | Japko |
| ZS09148 | ZSA09148 | ZSJ09148 |

O. E. M.: 1Z5827550

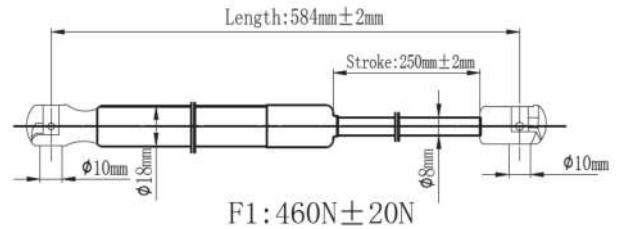

| | | |
|------------|----------|----------|
| Japanparts | Ashika | Japko |
| ZS09149 | ZSA09149 | ZSJ09149 |

O. E. M.: 5L6827550

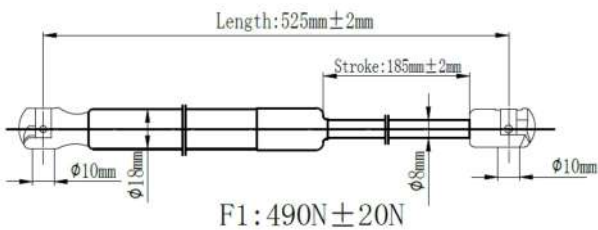

| | | |
|------------|----------|----------|
| Japanparts | Ashika | Japko |
| ZS09150 | ZSA09150 | ZSJ09150 |

O. E. M.: 3T9827550

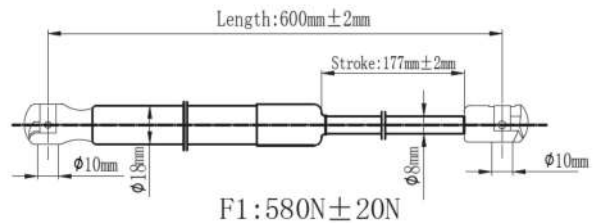

| | | |
|------------|----------|----------|
| Japanparts | Ashika | Japko |
| ZS09151 | ZSA09151 | ZSJ09151 |

O. E. M.: 5JJ827550A

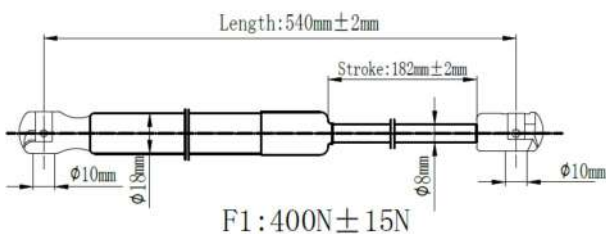

| | | |
|------------|----------|----------|
| Japanparts | Ashika | Japko |
| ZS09152 | ZSA09152 | ZSJ09152 |

O. E. M.: 3T5827550

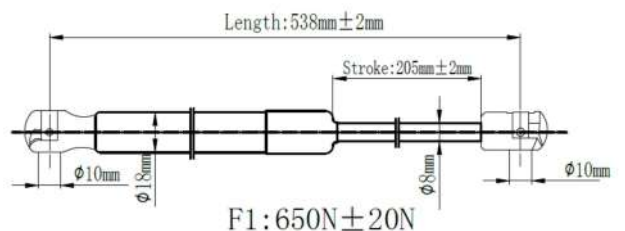

| | | |
|------------|----------|----------|
| Japanparts | Ashika | Japko |
| ZS09153 | ZSA09153 | ZSJ09153 |

O. E. M.: 1U6827550E

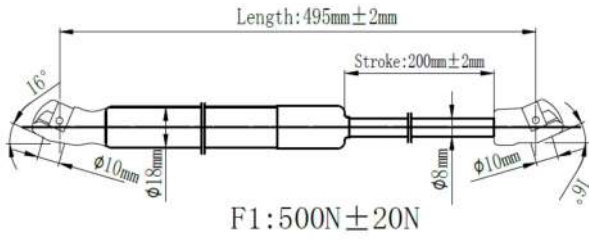

| | | |
|------------|----------|----------|
| Japanparts | Ashika | Japko |
| ZS09154 | ZSA09154 | ZSJ09154 |

O. E. M.: 5E9827550

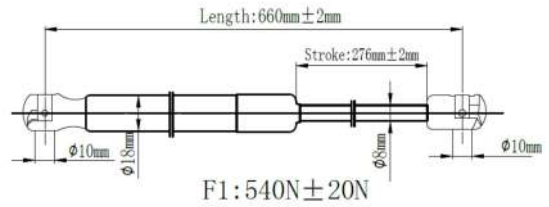

| | | |
|------------|----------|----------|
| Japanparts | Ashika | Japko |
| ZS09155 | ZSA09155 | ZSJ09155 |

O. E. M.: 5E5827550M

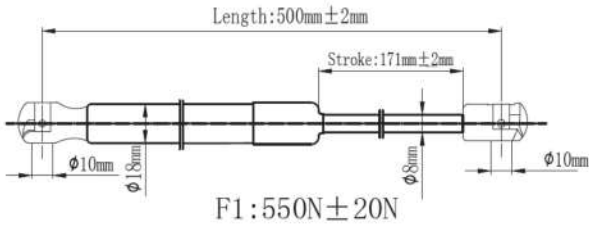

| | | |
|------------|----------|----------|
| Japanparts | Ashika | Japko |
| ZS09156 | ZSA09156 | ZSJ09156 |

O. E. M.: 5JA827550

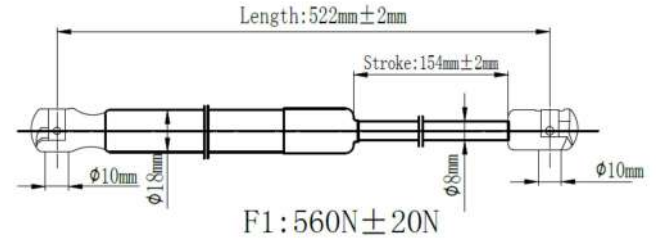

| | | |
|------------|----------|----------|
| Japanparts | Ashika | Japko |
| ZS09157 | ZSA09157 | ZSJ09157 |

O. E. M.: 147827550

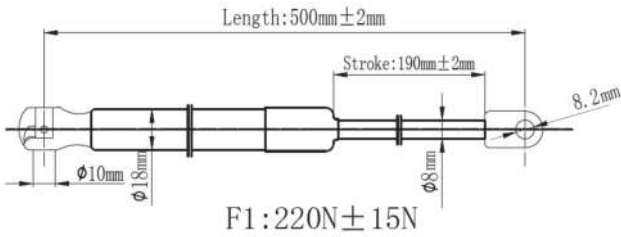

| | | |
|------------|----------|----------|
| Japanparts | Ashika | Japko |
| ZS09158 | ZSA09158 | ZSJ09158 |

O. E. M.: 535827550

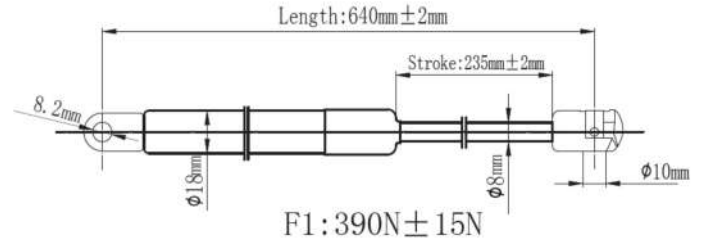

| | | |
|------------|----------|----------|
| Japanparts | Ashika | Japko |
| ZS09159 | ZSA09159 | ZSJ09159 |

O. E. M.: 171827550A

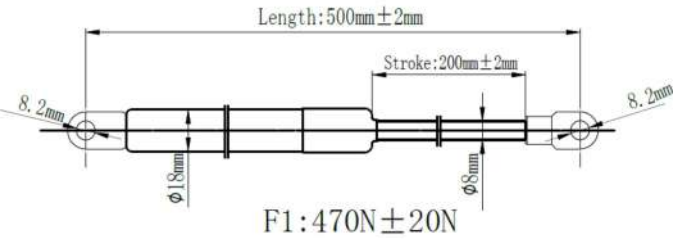

| | | |
|------------|----------|----------|
| Japanparts | Ashika | Japko |
| ZS09160 | ZSA09160 | ZSJ09160 |

O. E. M.: 155827550A

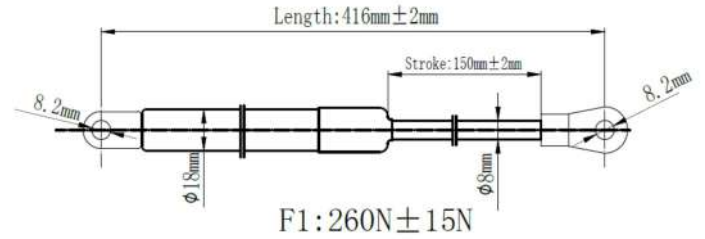

| | | |
|------------|----------|----------|
| Japanparts | Ashika | Japko |
| ZS09161 | ZSA09161 | ZSJ09161 |

O. E. M.: 1H9827550A

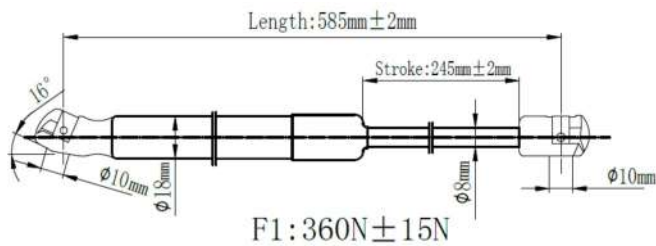

| | | |
|------------|----------|----------|
| Japanparts | Ashika | Japko |
| ZS09162 | ZSA09162 | ZSJ09162 |

O. E. M.: 1E0827550

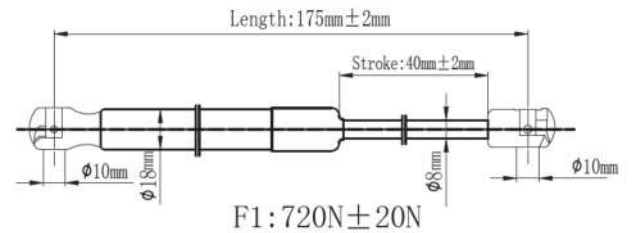

| | | |
|------------|----------|----------|
| Japanparts | Ashika | Japko |
| ZS09163 | ZSA09163 | ZSJ09163 |

O. E. M.: 871827550

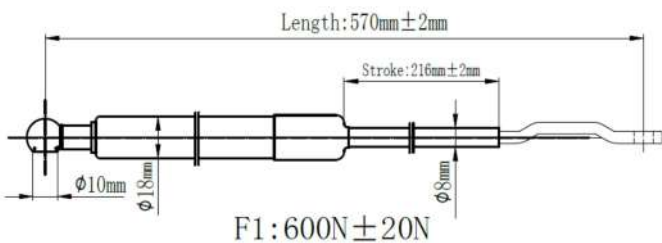

| | | |
|------------|----------|----------|
| Japanparts | Ashika | Japko |
| ZS09164 | ZSA09164 | ZSJ09164 |

O. E. M.: 533827550

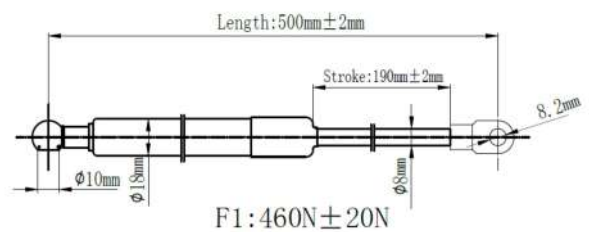

| | | |
|------------|----------|----------|
| Japanparts | Ashika | Japko |
| ZS09165 | ZSA09165 | ZSJ09165 |

O. E. M.: 377827550C

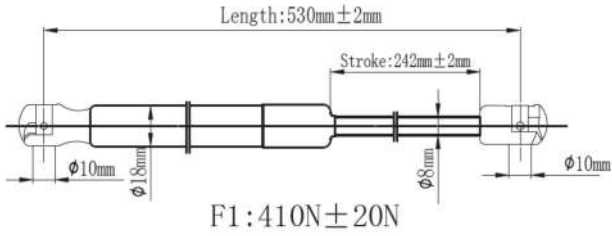

| | | |
|------------|----------|----------|
| Japanparts | Ashika | Japko |
| ZS09166 | ZSA09166 | ZSJ09166 |

O. E. M.: 1H5827550A

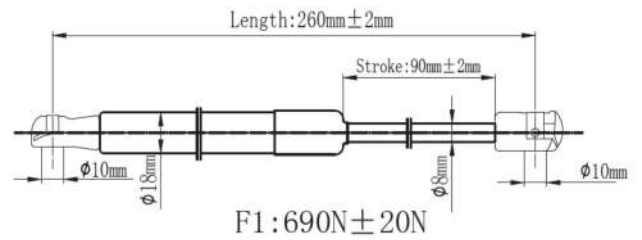

| | | |
|------------|----------|----------|
| Japanparts | Ashika | Japko |
| ZS09167 | ZSA09167 | ZSJ09167 |

O. E. M.: 7H0 823 359 A

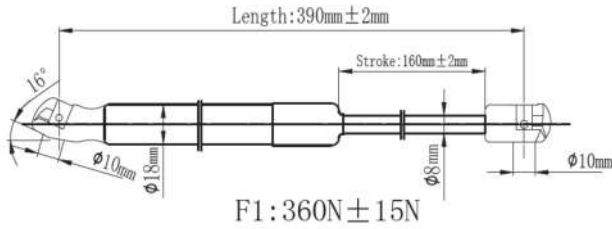

| | | |
|------------|----------|----------|
| Japanparts | Ashika | Japko |
| ZS09168 | ZSA09168 | ZSJ09168 |

O. E. M.: 7H0827550B

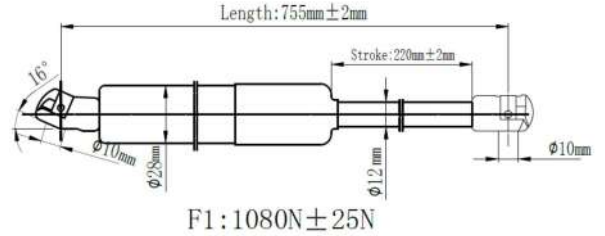

| | | |
|------------|----------|----------|
| Japanparts | Ashika | Japko |
| ZS09169 | ZSA09169 | ZSJ09169 |

O. E. M.: 1H6827550

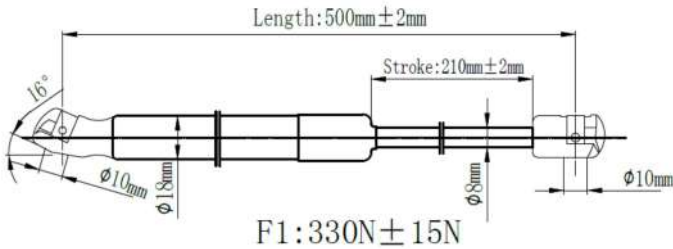

| | | |
|------------|----------|----------|
| Japanparts | Ashika | Japko |
| ZS09170 | ZSA09170 | ZSJ09170 |

O. E. M.: 333827550

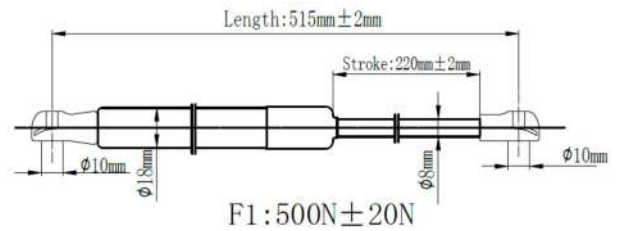

| | | |
|------------|----------|----------|
| Japanparts | Ashika | Japko |
| ZS09171 | ZSA09171 | ZSJ09171 |

O. E. M.: 6N0827550

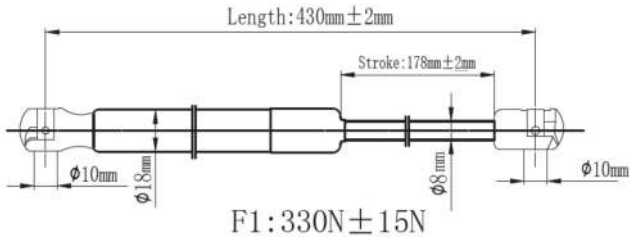

| | | |
|------------|----------|----------|
| Japanparts | Ashika | Japko |
| ZS09172 | ZSA09172 | ZSJ09172 |

O. E. M.: 701829331F

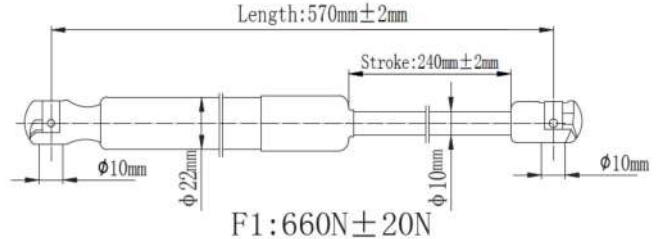

| | | |
|------------|----------|----------|
| Japanparts | Ashika | Japko |
| ZS09173 | ZSA09173 | ZSJ09173 |

O. E. M.: 701829331AB

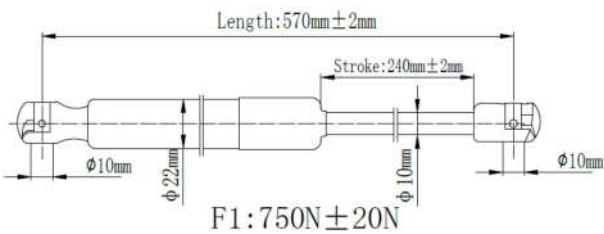

| | | |
|------------|----------|----------|
| Japanparts | Ashika | Japko |
| ZS09174 | ZSA09174 | ZSJ09174 |

O. E. M.: 701829331D

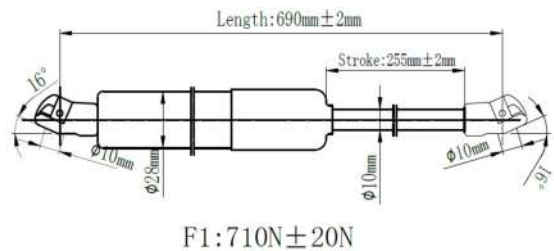

| | | |
|------------|----------|----------|
| Japanparts | Ashika | Japko |
| ZS09175 | ZSA09175 | ZSJ09175 |

O. E. M.: 119827550

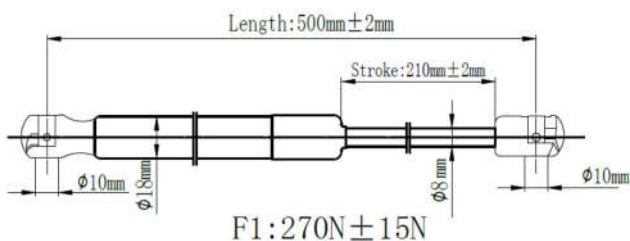

| | | |
|------------|----------|----------|
| Japanparts | Ashika | Japko |
| ZS09176 | ZSA09176 | ZSJ09176 |

O. E. M.: 7L6823359B

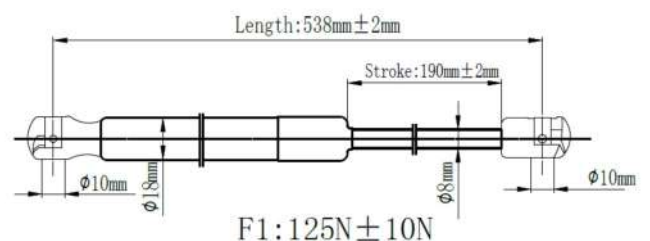

| | | |
|------------|----------|----------|
| Japanparts | Ashika | Japko |
| ZS09177 | ZSA09177 | ZSJ09177 |

O. E. M.: 6N0823359

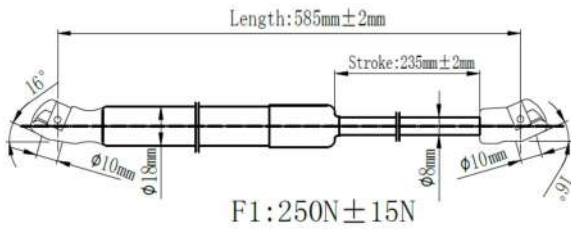

F1: 250N ± 15N

| | | |
|------------|----------|----------|
| Japanparts | Ashika | Japko |
| ZS09178 | ZSA09178 | ZSJ09178 |

O. E. M.: 6Q6827550

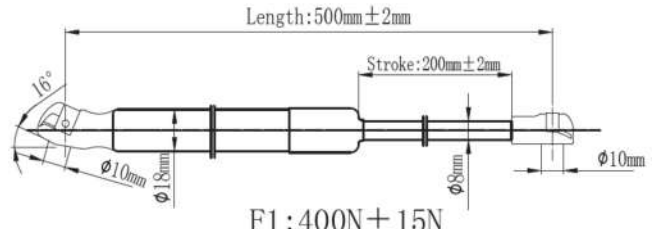

F1: 400N ± 15N

| | | |
|------------|----------|----------|
| Japanparts | Ashika | Japko |
| ZS09179 | ZSA09179 | ZSJ09179 |

O. E. M.: 331827550

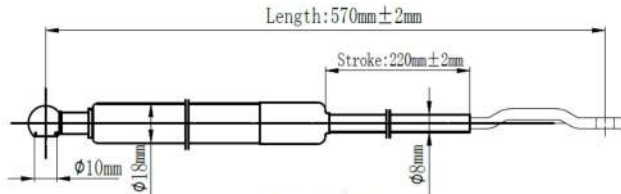

F1: 380N ± 15N

| | | |
|------------|----------|----------|
| Japanparts | Ashika | Japko |
| ZS09180 | ZSA09180 | ZSJ09180 |

O. E. M.: 251829331

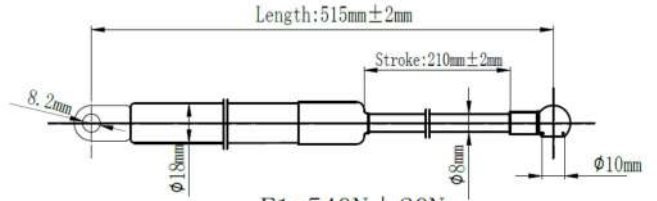

F1: 540N ± 20N

| | | |
|------------|----------|----------|
| Japanparts | Ashika | Japko |
| ZS09181 | ZSA09181 | ZSJ09181 |

O. E. M.: 1J6827550E

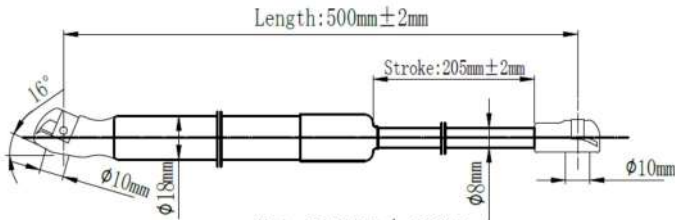

F1: 500N ± 20N

| | | |
|------------|----------|----------|
| Japanparts | Ashika | Japko |
| ZS09182 | ZSA09182 | ZSJ09182 |

O. E. M.: 1K6827550B

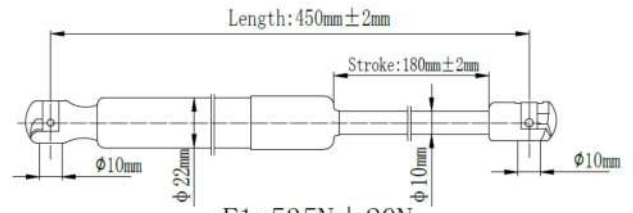

F1: 535N ± 20N

| | | |
|------------|----------|----------|
| Japanparts | Ashika | Japko |
| ZS09183 | ZSA09183 | ZSJ09183 |

O. E. M.: 1T0823359A

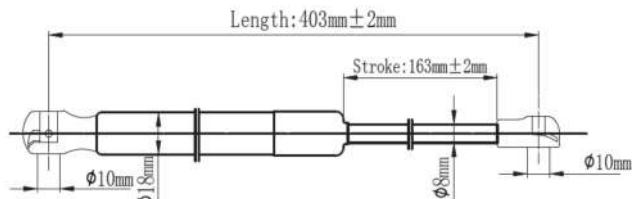

F1: 460N ± 20N

| | | |
|------------|----------|----------|
| Japanparts | Ashika | Japko |
| ZS09184 | ZSA09184 | ZSJ09184 |

O. E. M.: 7P6823359

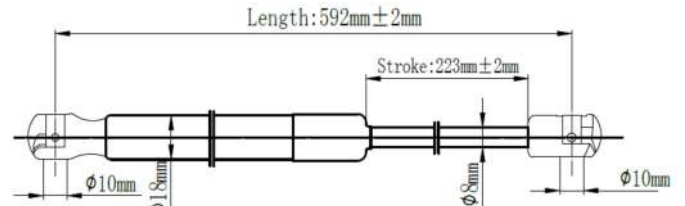

F1: 605N ± 20N

| | | |
|------------|----------|----------|
| Japanparts | Ashika | Japko |
| ZS09185 | ZSA09185 | ZSJ09185 |

O. E. M.: 7L6845587

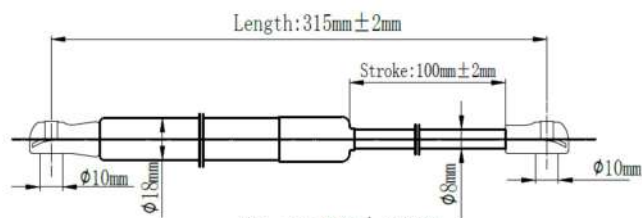

F1: 550N ± 20N

| | | |
|------------|----------|----------|
| Japanparts | Ashika | Japko |
| ZS09186 | ZSA09186 | ZSJ09186 |

O. E. M.: 1C0827550A

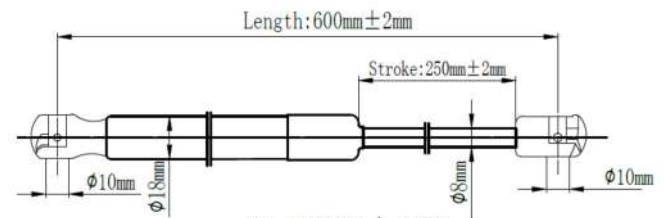

F1: 330N ± 15N

| | | |
|------------|----------|----------|
| Japanparts | Ashika | Japko |
| ZS09187 | ZSA09187 | ZSJ09187 |

O. E. M.: 3C9827550

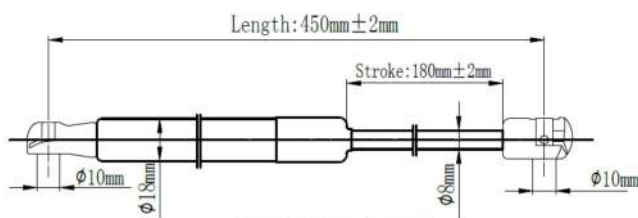

F1: 550N ± 20N

| | | |
|------------|----------|----------|
| Japanparts | Ashika | Japko |
| ZS09188 | ZSA09188 | ZSJ09188 |

O. E. M.: 1T0827550D

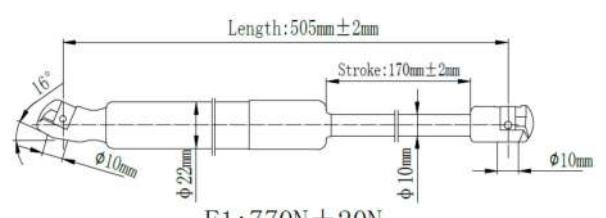

F1: 770N ± 20N

| | | |
|------------|----------|----------|
| Japanparts | Ashika | Japko |
| ZS09189 | ZSA09189 | ZSJ09189 |

O. E. M.: 1K0823359A

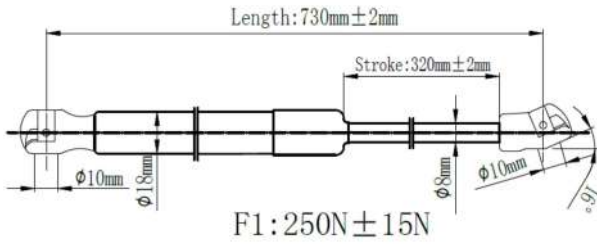

| | | |
|------------|----------|----------|
| Japanparts | Ashika | Japko |
| ZS09190 | ZSA09190 | ZSJ09190 |

O. E. M.: 576827550B

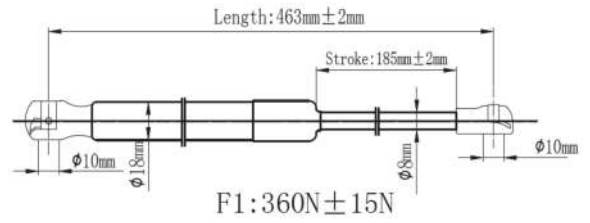

| | | |
|------------|----------|----------|
| Japanparts | Ashika | Japko |
| ZS09191 | ZSA09191 | ZSJ09191 |

O. E. M.: 7L6823359B

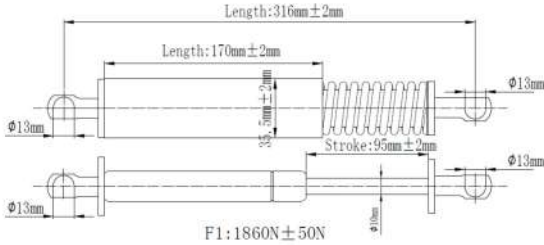

| | | |
|------------|----------|----------|
| Japanparts | Ashika | Japko |
| ZS09192 | ZSA09192 | ZSJ09192 |

O. E. M.: 6Q5827550A

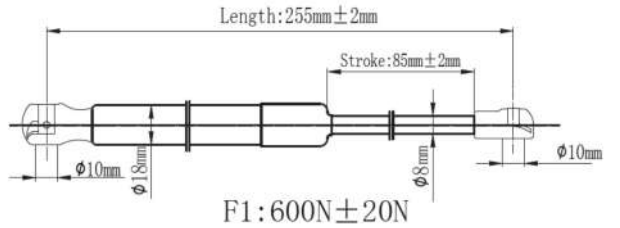

| | | |
|------------|----------|----------|
| Japanparts | Ashika | Japko |
| ZS09193 | ZSA09193 | ZSJ09193 |

O. E. M.: 6R6 827 550 A

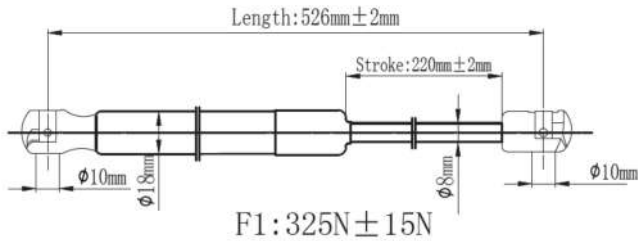

| | | |
|------------|----------|----------|
| Japanparts | Ashika | Japko |
| ZS09194 | ZSA09194 | ZSJ09194 |

O. E. M.: 1Q0823359

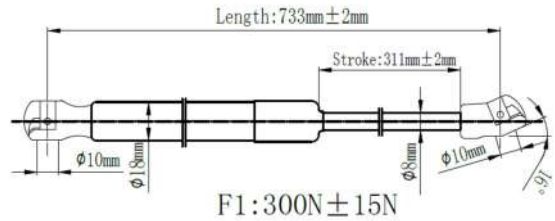

| | | |
|------------|----------|----------|
| Japanparts | Ashika | Japko |
| ZS09195 | ZSA09195 | ZSJ09195 |

O. E. M.: 5K0823359E

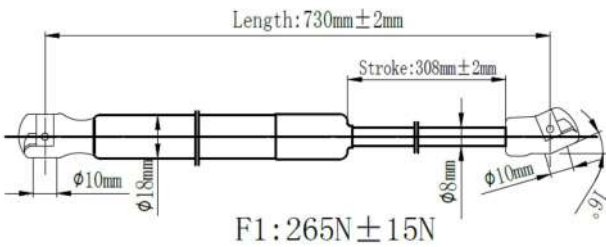

| | | |
|------------|----------|----------|
| Japanparts | Ashika | Japko |
| ZS09196 | ZSA09196 | ZSJ09196 |

O. E. M.: 3C5827550A

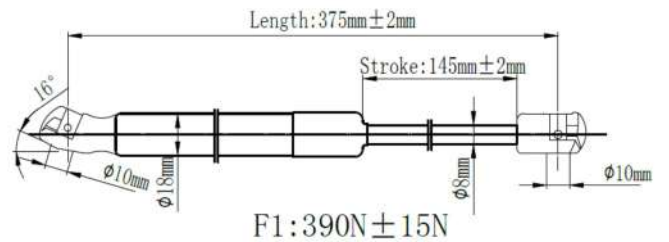

| | | |
|------------|----------|----------|
| Japanparts | Ashika | Japko |
| ZS09197 | ZSA09197 | ZSJ09197 |

O. E. M.: 3D5827550B

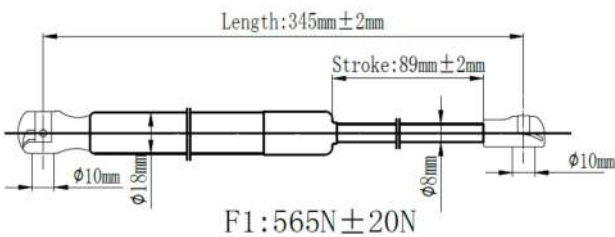

| | | |
|------------|----------|----------|
| Japanparts | Ashika | Japko |
| ZS09198 | ZSA09198 | ZSJ09198 |

O. E. M.: 3C8823359

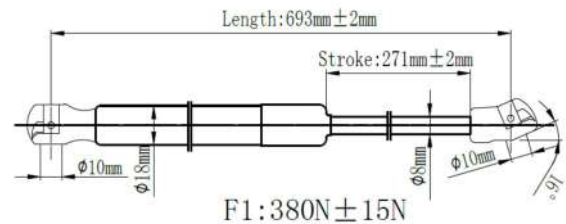

| | | |
|------------|----------|----------|
| Japanparts | Ashika | Japko |
| ZS09199 | ZSA09199 | ZSJ09199 |

O. E. M.: 1K8827550A

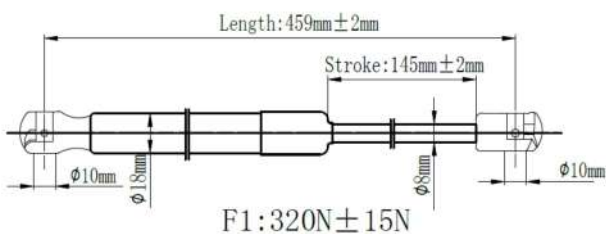

| | | |
|------------|----------|----------|
| Japanparts | Ashika | Japko |
| ZS09200 | ZSA09200 | ZSJ09200 |

O. E. M.: 5N0827550D

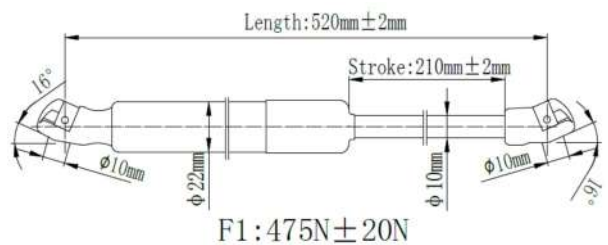

| | | |
|------------|----------|----------|
| Japanparts | Ashika | Japko |
| ZS09201 | ZSA09201 | ZSJ09201 |

O. E. M.: 867827550

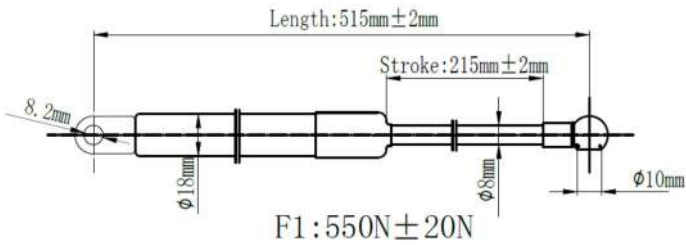

| | | |
|------------|----------|----------|
| Japanparts | Ashika | Japko |
| ZS09202 | ZSA09202 | ZSJ09202 |

O. E. M.: 6R6827550A

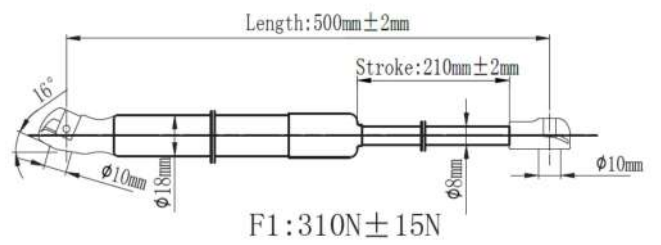

| | | |
|------------|----------|----------|
| Japanparts | Ashika | Japko |
| ZS09203 | ZSA09203 | ZSJ09203 |

O. E. M.: 1K5827550C

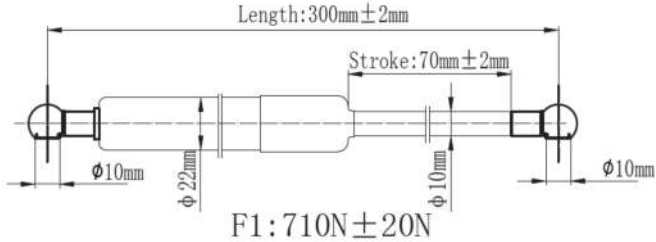

| | | |
|------------|----------|----------|
| Japanparts | Ashika | Japko |
| ZS09204 | ZSA09204 | ZSJ09204 |

O. E. M.: 191827550A

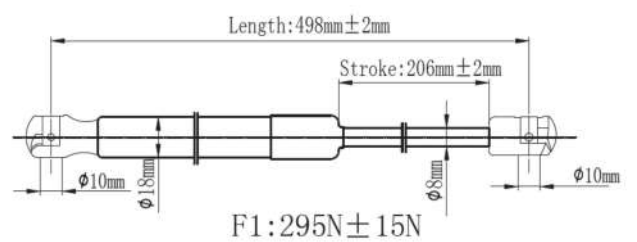

| | | |
|------------|----------|----------|
| Japanparts | Ashika | Japko |
| ZS09205 | ZSA09205 | ZSJ09205 |

O. E. M.: 1S6827550D

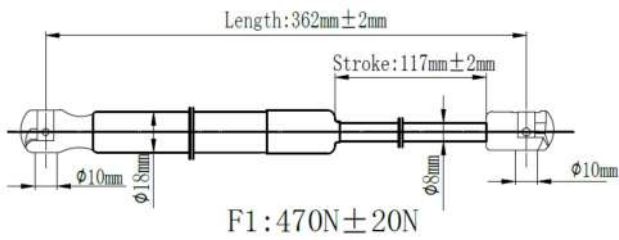

| | | |
|------------|----------|----------|
| Japanparts | Ashika | Japko |
| ZS09206 | ZSA09206 | ZSJ09206 |

O. E. M.: 1T0827550H

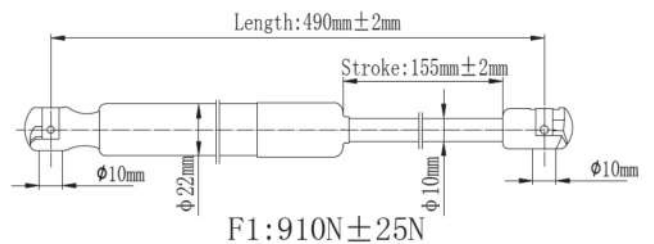

| | | |
|------------|----------|----------|
| Japanparts | Ashika | Japko |
| ZS09207 | ZSA09207 | ZSJ09207 |

O. E. M.: 3A827550A

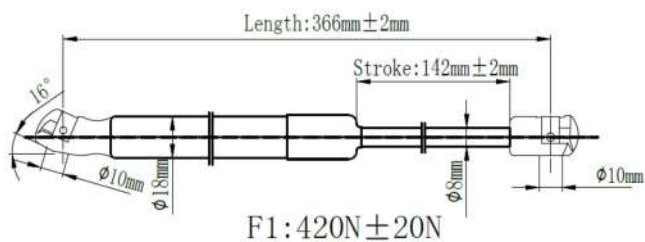

| | | |
|------------|----------|----------|
| Japanparts | Ashika | Japko |
| ZS09208 | ZSA09208 | ZSJ09208 |

O. E. M.: 5C5827550H

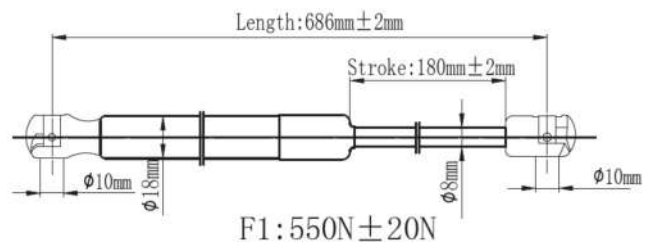

| | | |
|------------|----------|----------|
| Japanparts | Ashika | Japko |
| ZS09209 | ZSA09209 | ZSJ09209 |

O. E. M.: 5C6827550

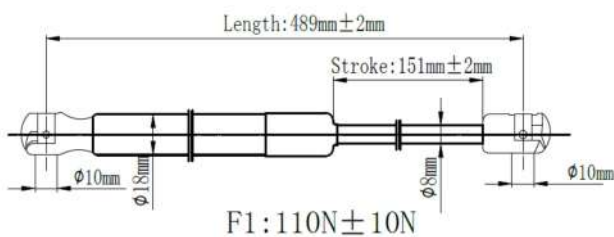

| | | |
|------------|----------|----------|
| Japanparts | Ashika | Japko |
| ZS09210 | ZSA09210 | ZSJ09210 |

O. E. M.: 5G6827550C

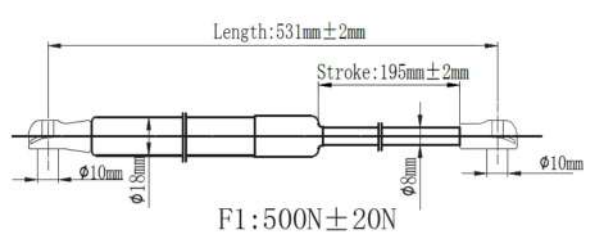

| | | |
|------------|----------|----------|
| Japanparts | Ashika | Japko |
| ZS09211 | ZSA09211 | ZSJ09211 |

O. E. M.: 5G9827550

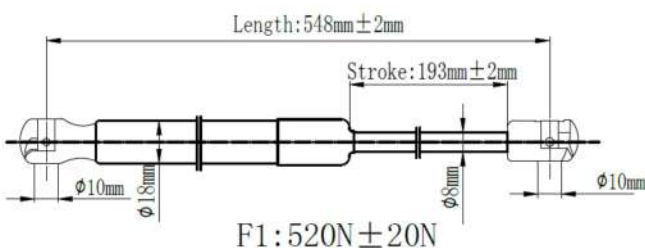

| | | |
|------------|----------|----------|
| Japanparts | Ashika | Japko |
| ZS09212 | ZSA09212 | ZSJ09212 |

O. E. M.: 3AF827550A

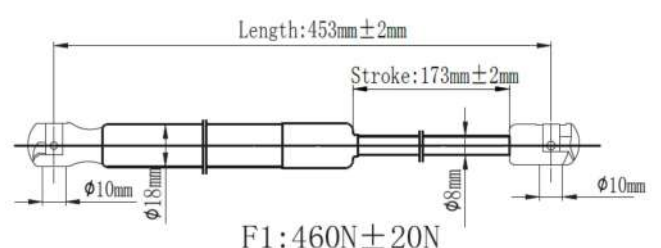

| | | |
|------------|----------|----------|
| Japanparts | Ashika | Japko |
| ZS09213 | ZSA09213 | ZSJ09213 |

O. E. M.: 155871997A

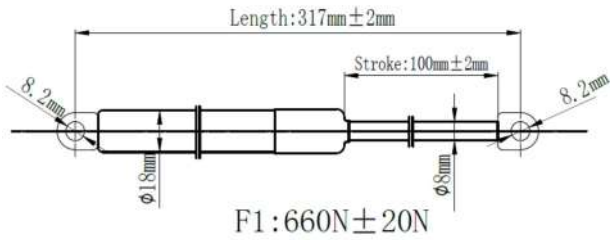

| | | |
|------------|----------|----------|
| Japanparts | Ashika | Japko |
| ZS09214 | ZSA09214 | ZSJ09214 |

O. E. M.: 7D0823359A

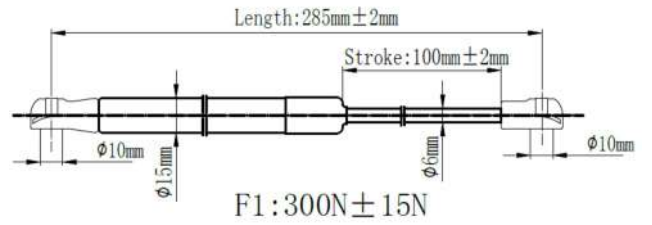

| | | |
|------------|----------|----------|
| Japanparts | Ashika | Japko |
| ZS09215 | ZSA09215 | ZSJ09215 |

O. E. M.: 2K0827550

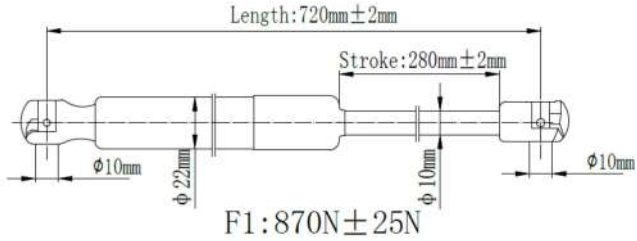

| | | |
|------------|----------|----------|
| Japanparts | Ashika | Japko |
| ZS09216 | ZSA09216 | ZSJ09216 |

O. E. M.: 1K9827550B

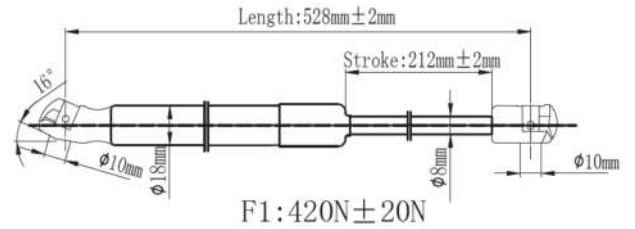

| | | |
|------------|----------|----------|
| Japanparts | Ashika | Japko |
| ZS09217 | ZSA09217 | ZSJ09217 |

O. E. M.: 1Y0827550B

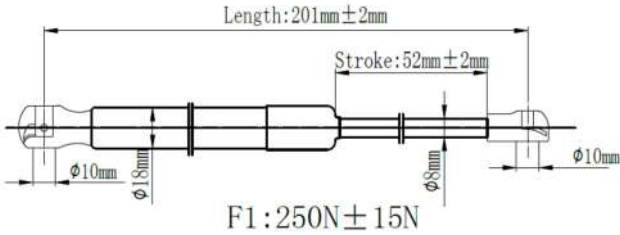

| | | |
|------------|----------|----------|
| Japanparts | Ashika | Japko |
| ZS09218 | ZSA09218 | ZSJ09218 |

O. E. M.: 5M0827550

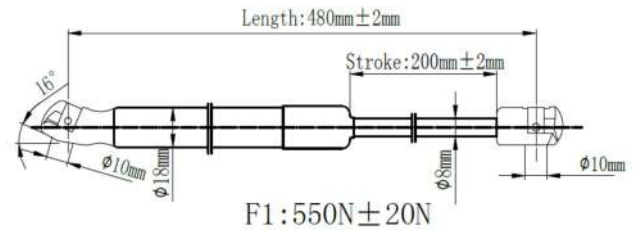

| | | |
|------------|----------|----------|
| Japanparts | Ashika | Japko |
| ZS09219 | ZSA09219 | ZSJ09219 |

O. E. M.: 3C0823359

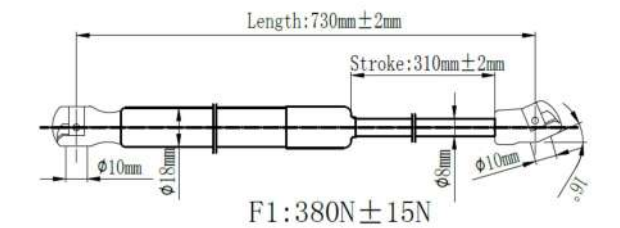

| | | |
|------------|----------|----------|
| Japanparts | Ashika | Japko |
| ZS09220 | ZSA09220 | ZSJ09220 |

O. E. M.: 5K6827550B

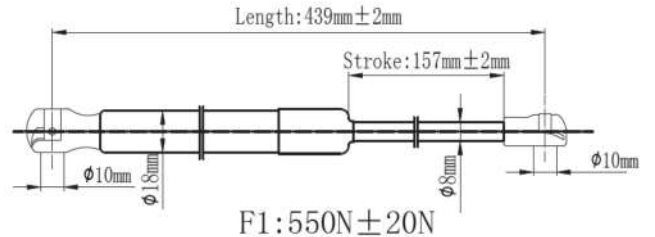

| | | |
|------------|----------|----------|
| Japanparts | Ashika | Japko |
| ZS09221 | ZSA09221 | ZSJ09221 |

O. E. M.: 1C0823359B

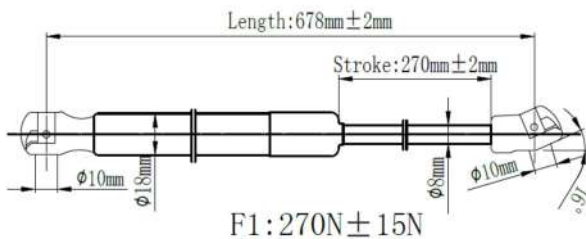

| | | |
|------------|----------|----------|
| Japanparts | Ashika | Japko |
| ZS09222 | ZSA09222 | ZSJ09222 |

O. E. M.: 3AA823359023

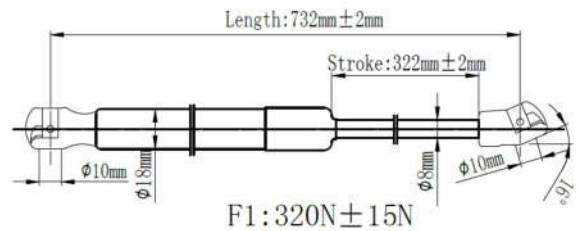

| | | |
|------------|----------|----------|
| Japanparts | Ashika | Japko |
| ZS09223 | ZSA09223 | ZSJ09223 |

O. E. M.: 1T0823359D

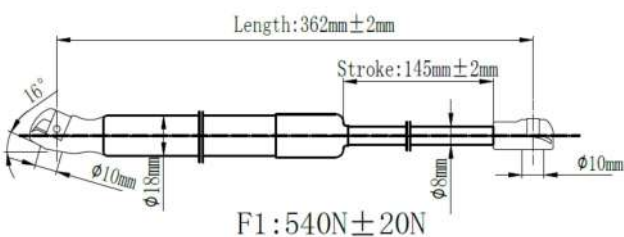

| | | |
|------------|----------|----------|
| Japanparts | Ashika | Japko |
| ZS09224 | ZSA09224 | ZSJ09224 |

O. E. M.: 531827550B

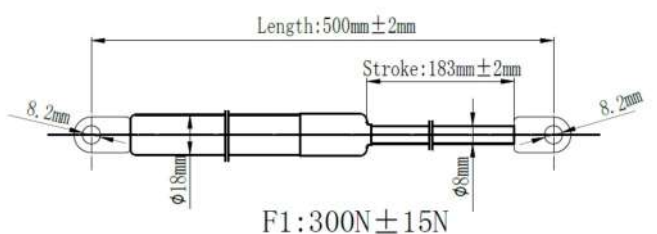

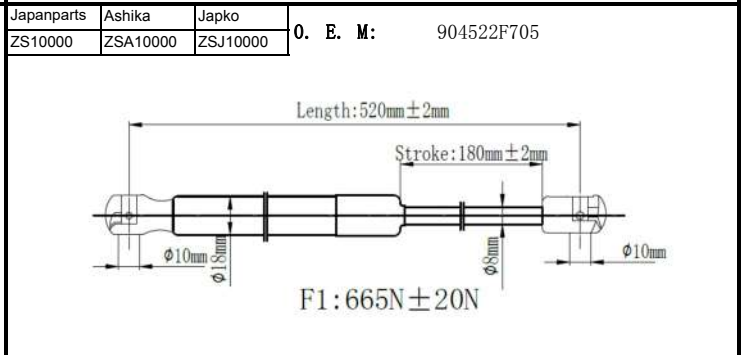
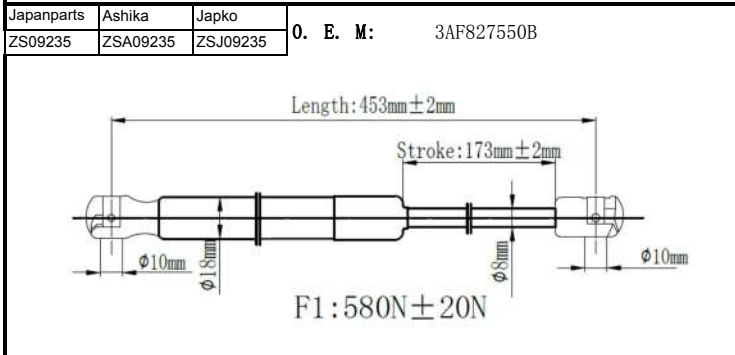
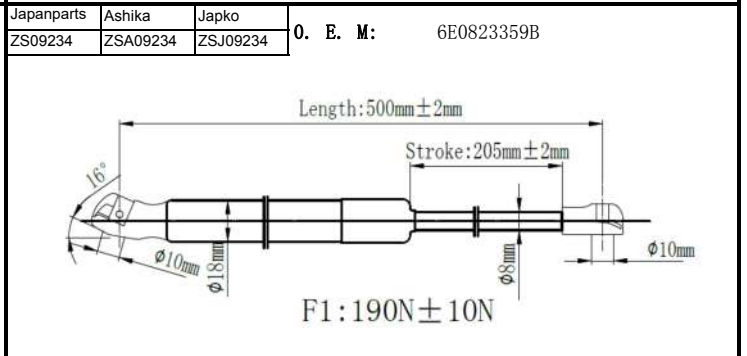
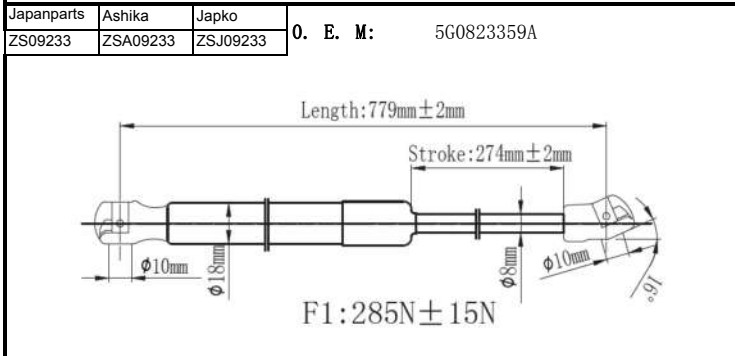
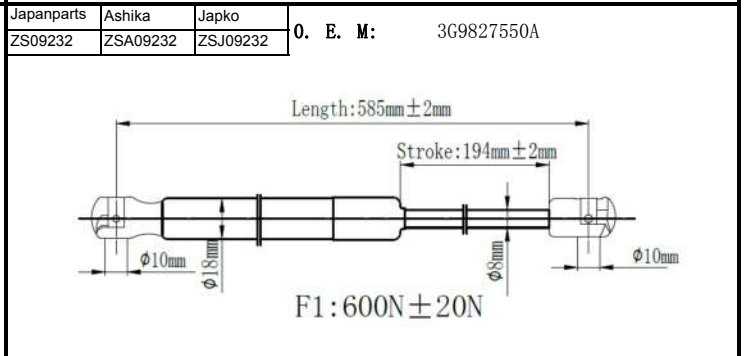
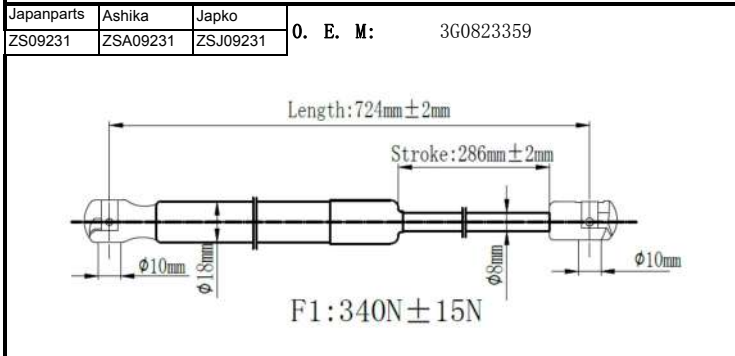
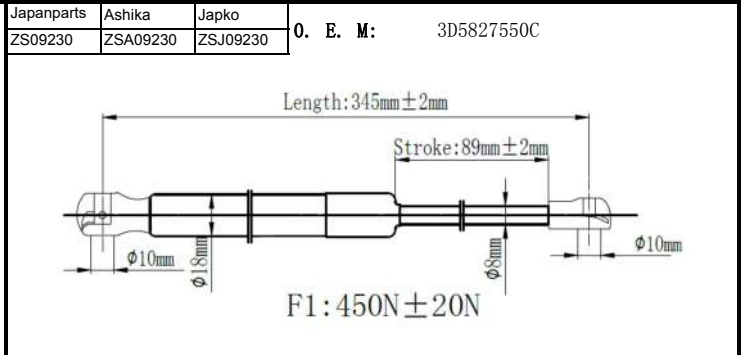
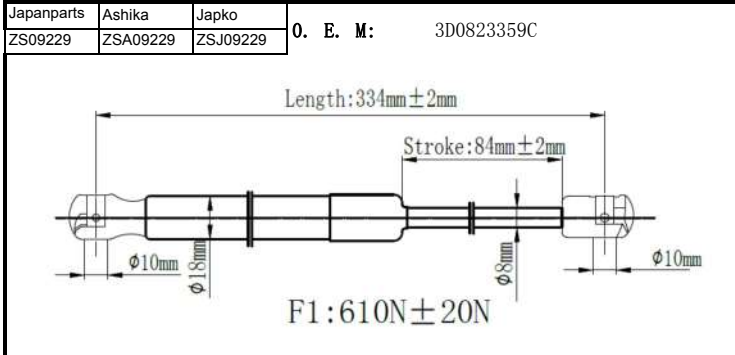
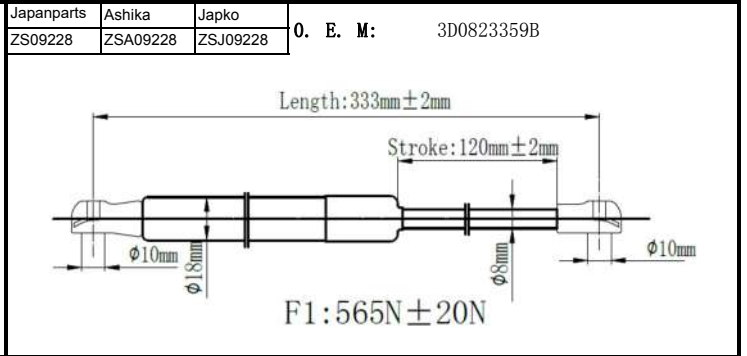
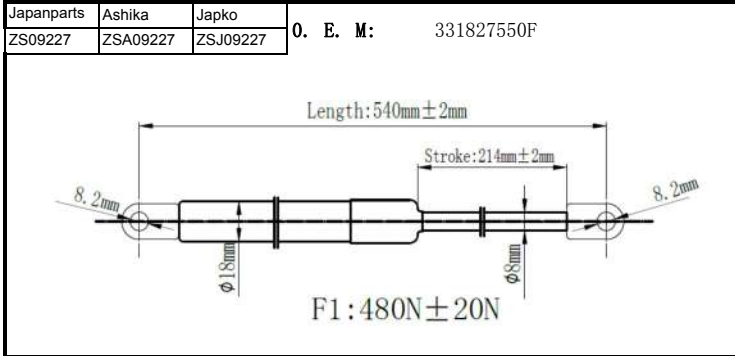
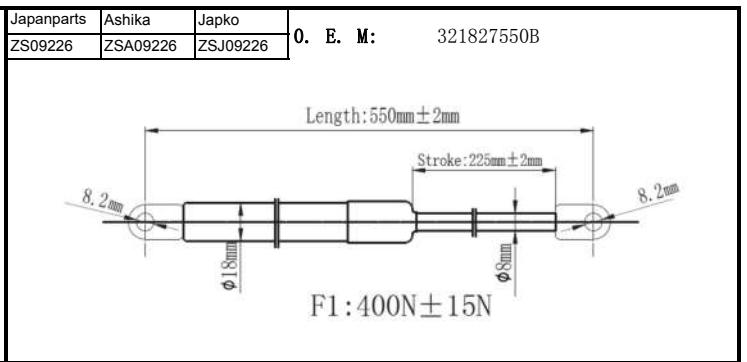
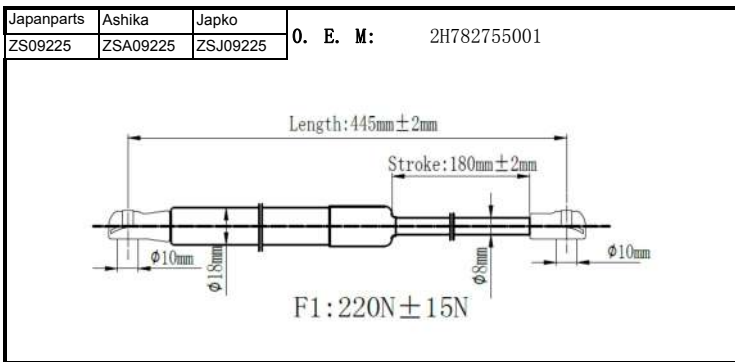

| | | |
|------------|----------|----------|
| Japanparts | Ashika | Japko |
| ZS10001 | ZSA10001 | ZSJ10001 |

O. E. M.: 84430AV600

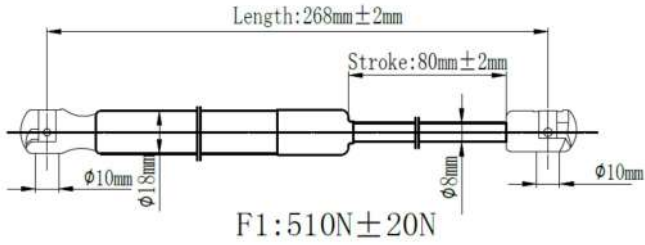

| | | |
|------------|----------|----------|
| Japanparts | Ashika | Japko |
| ZS10002 | ZSA10002 | ZSJ10002 |

O. E. M.: 6547040U10

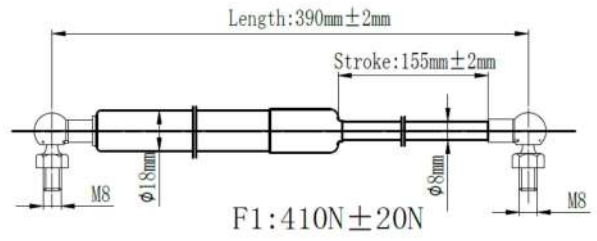

| | | |
|------------|----------|----------|
| Japanparts | Ashika | Japko |
| ZS10003 | ZSA10003 | ZSJ10003 |

O. E. M.: 90452AV700

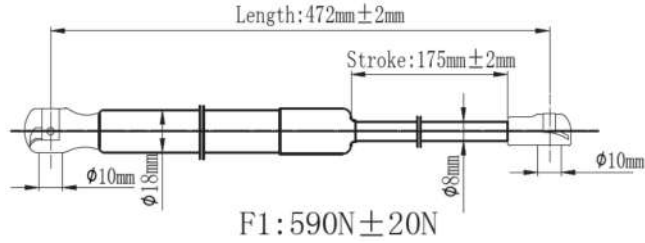

| | | |
|------------|----------|----------|
| Japanparts | Ashika | Japko |
| ZS10004 | ZSA10004 | ZSJ10004 |

O. E. M.: 904528F810

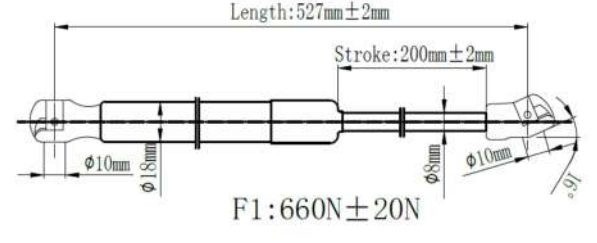

| | | |
|------------|----------|----------|
| Japanparts | Ashika | Japko |
| ZS10005 | ZSA10005 | ZSJ10005 |

O. E. M.: 904523F200

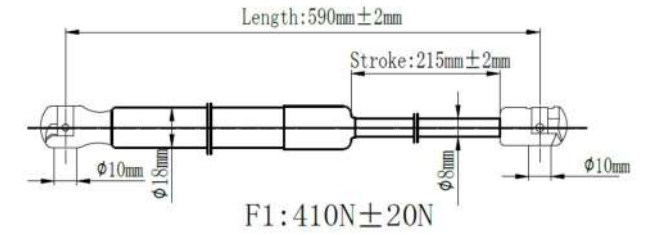

| | | |
|------------|----------|----------|
| Japanparts | Ashika | Japko |
| ZS10006 | ZSA10006 | ZSJ10006 |

O. E. M.: 9045079N00

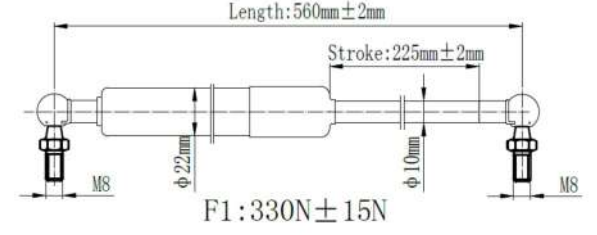

| | | |
|------------|----------|----------|
| Japanparts | Ashika | Japko |
| ZS10007 | ZSA10007 | ZSJ10007 |

O. E. M.: 90450 8H31A

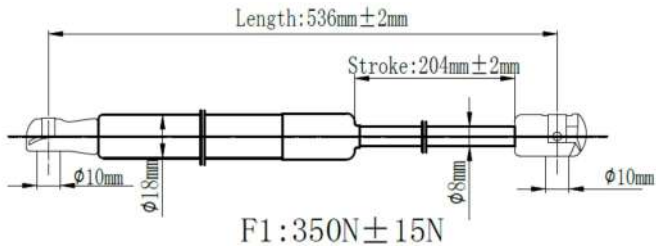

| | | |
|------------|----------|----------|
| Japanparts | Ashika | Japko |
| ZS10008 | ZSA10008 | ZSJ10008 |

O. E. M.: 904522F715

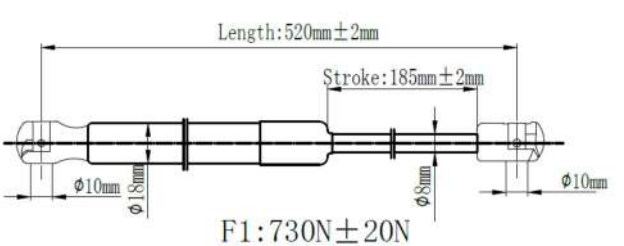

| | | |
|------------|----------|----------|
| Japanparts | Ashika | Japko |
| ZS10009 | ZSA10009 | ZSJ10009 |

O. E. M.: 90450BU000

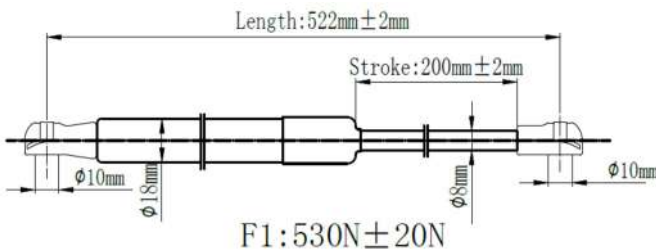

| | | |
|------------|----------|----------|
| Japanparts | Ashika | Japko |
| ZS10010 | ZSA10010 | ZSJ10010 |

O. E. M.: 904504F110

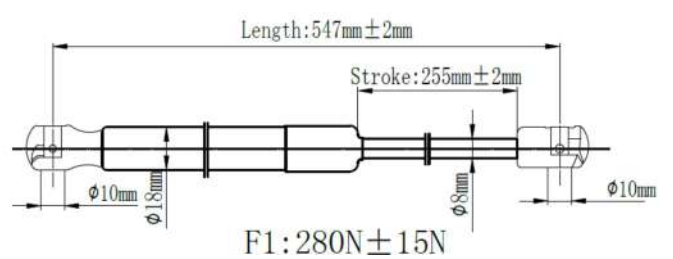

| | | |
|------------|----------|----------|
| Japanparts | Ashika | Japko |
| ZS10011 | ZSA10011 | ZSJ10011 |

O. E. M.: 844302F000

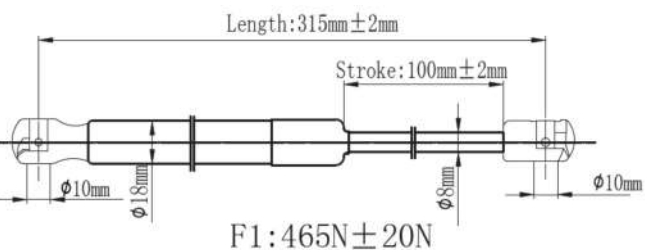

| | | |
|------------|----------|----------|
| Japanparts | Ashika | Japko |
| ZS10012 | ZSA10012 | ZSJ10012 |

O. E. M.: 90450AX000

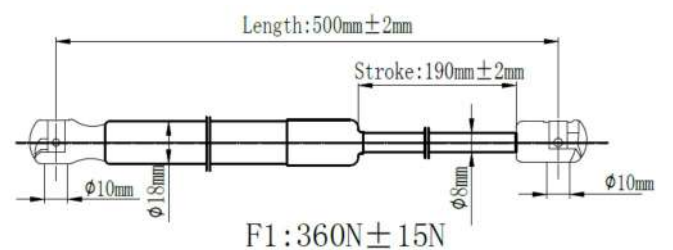

| | | |
|------------|----------|----------|
| Japanparts | Ashika | Japko |
| ZS10013 | ZSA10013 | ZSJ10013 |

O. E. M.: 904523F202

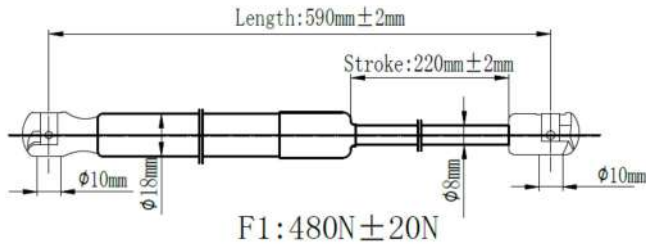

| | | |
|------------|----------|----------|
| Japanparts | Ashika | Japko |
| ZS10014 | ZSA10014 | ZSJ10014 |

O. E. M.: 90450JD01B

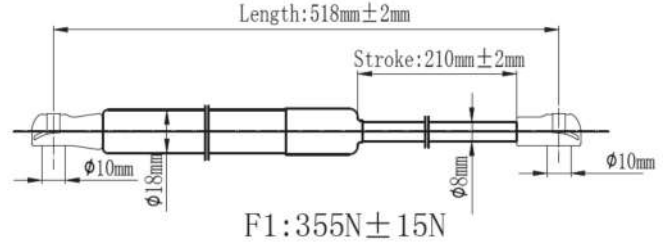

| | | |
|------------|----------|----------|
| Japanparts | Ashika | Japko |
| ZS10015 | ZSA10015 | ZSJ10015 |

O. E. M.: 9045001B00

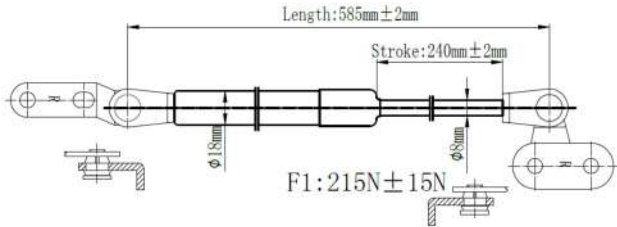

| | | |
|------------|----------|----------|
| Japanparts | Ashika | Japko |
| ZS10016 | ZSA10016 | ZSJ10016 |

O. E. M.: 90440BW010

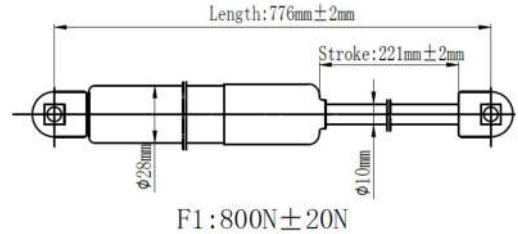

| | | |
|------------|----------|----------|
| Japanparts | Ashika | Japko |
| ZS10017 | ZSA10017 | ZSJ10017 |

O. E. M.: 904509U00A

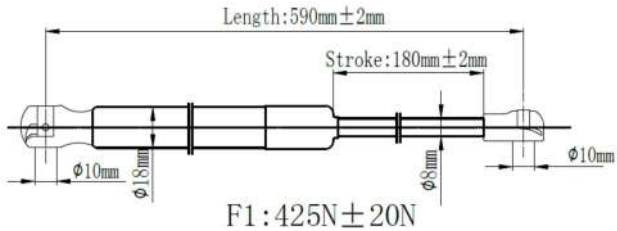

| | | |
|------------|----------|----------|
| Japanparts | Ashika | Japko |
| ZS10018 | ZSA10018 | ZSJ10018 |

O. E. M.: 904508H310

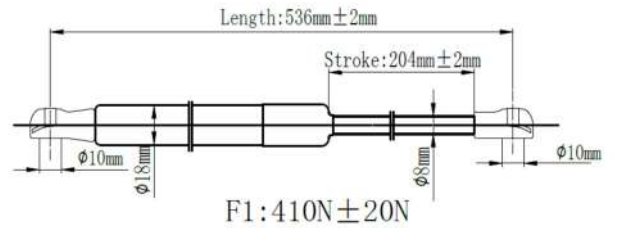

| | | |
|------------|----------|----------|
| Japanparts | Ashika | Japko |
| ZS10019 | ZSA10019 | ZSJ10019 |

O. E. M.: 90450JG400

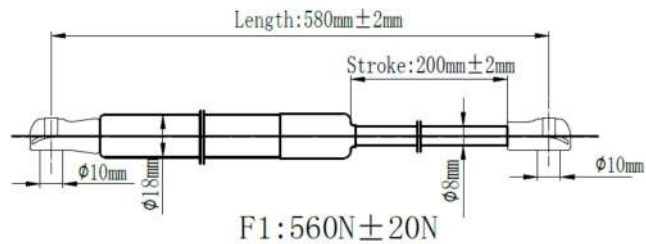

| | | |
|------------|----------|----------|
| Japanparts | Ashika | Japko |
| ZS10020 | ZSA10020 | ZSJ10020 |

O. E. M.: 90450EY10A

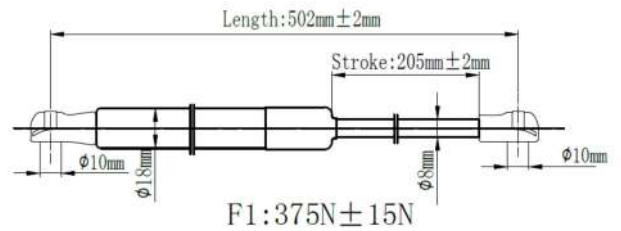

| | | |
|------------|----------|----------|
| Japanparts | Ashika | Japko |
| ZS10021 | ZSA10021 | ZSJ10021 |

O. E. M.: 65470CB801

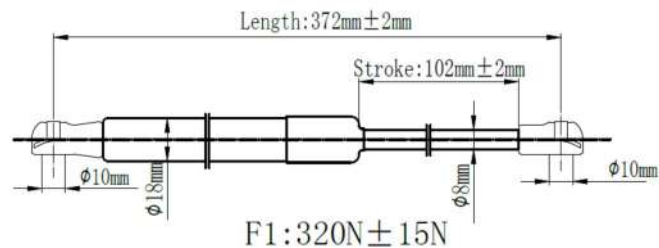

| | | |
|------------|----------|----------|
| Japanparts | Ashika | Japko |
| ZS10022 | ZSA10022 | ZSJ10022 |

O. E. M.: 65470VC020

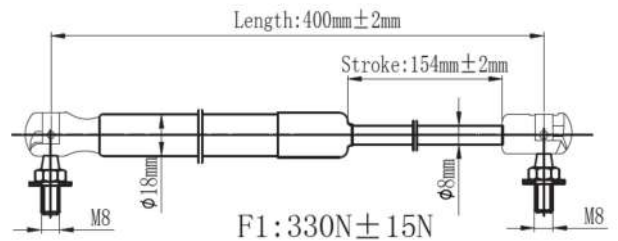

| | | |
|------------|----------|----------|
| Japanparts | Ashika | Japko |
| ZS10023 | ZSA10023 | ZSJ10023 |

O. E. M.: 904501HB0A

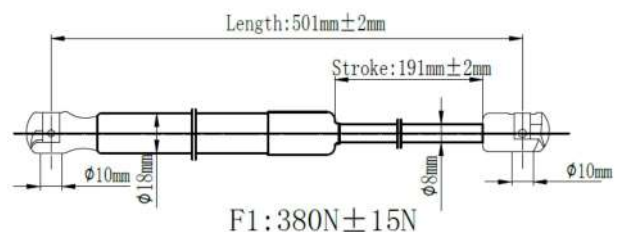

| | | |
|------------|----------|----------|
| Japanparts | Ashika | Japko |
| ZS10024 | ZSA10024 | ZSJ10024 |

O. E. M.: 904503HN0A

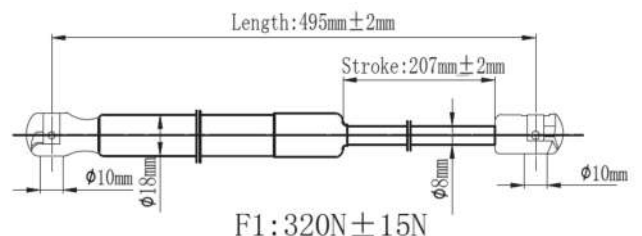

| | | |
|------------|----------|----------|
| Japanparts | Ashika | Japko |
| ZS10025 | ZSA10025 | ZSJ10025 |

O. E. M.: 904504EA0A

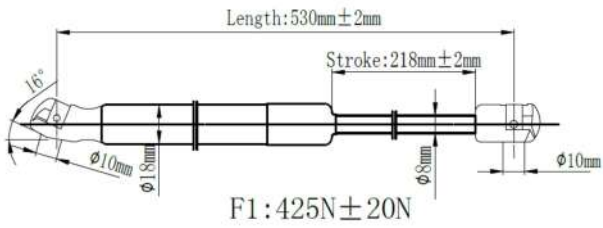

| | | |
|------------|----------|----------|
| Japanparts | Ashika | Japko |
| ZS10026 | ZSA10026 | ZSJ10026 |

O. E. M.: 9045050M10

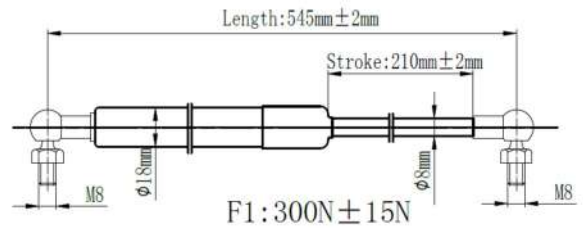

| | | |
|------------|----------|----------|
| Japanparts | Ashika | Japko |
| ZS10027 | ZSA10027 | ZSJ10027 |

O. E. M.: 904519C100

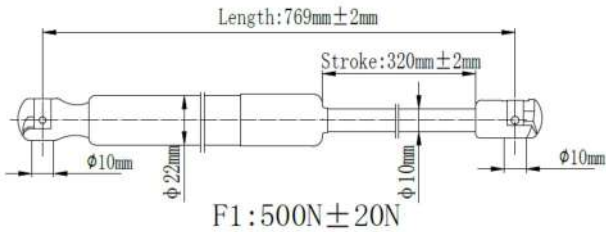

| | | |
|------------|----------|----------|
| Japanparts | Ashika | Japko |
| ZS10028 | ZSA10028 | ZSJ10028 |

O. E. M.: 904503LD0A

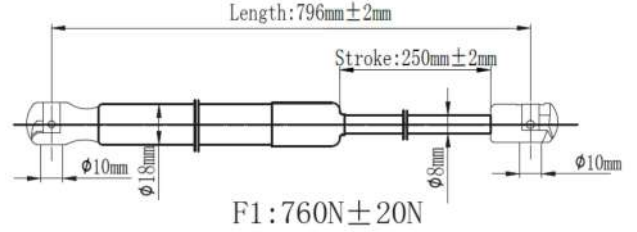

| | | |
|------------|----------|----------|
| Japanparts | Ashika | Japko |
| ZS10029 | ZSA10029 | ZSJ10029 |

O. E. M.: 654707S000

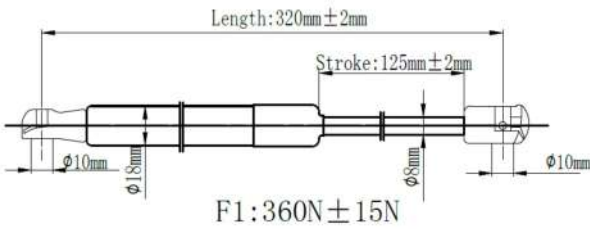

| | | |
|------------|----------|----------|
| Japanparts | Ashika | Japko |
| ZS10030 | ZSA10030 | ZSJ10030 |

O. E. M.: 84430ET80A

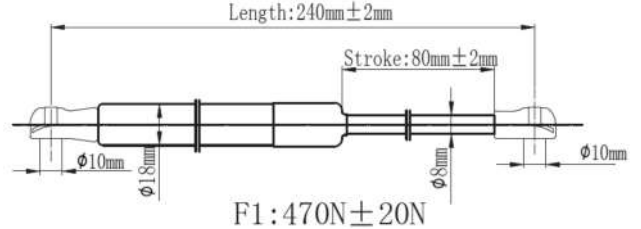

| | | |
|------------|----------|----------|
| Japanparts | Ashika | Japko |
| ZS10031 | ZSA10031 | ZSJ10031 |

O. E. M.: 654701AA0A

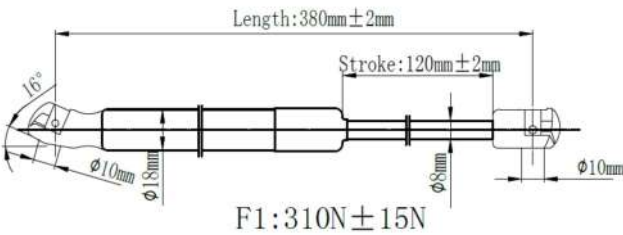

| | | |
|------------|----------|----------|
| Japanparts | Ashika | Japko |
| ZS10032 | ZSA10032 | ZSJ10032 |

O. E. M.: 90450CA000

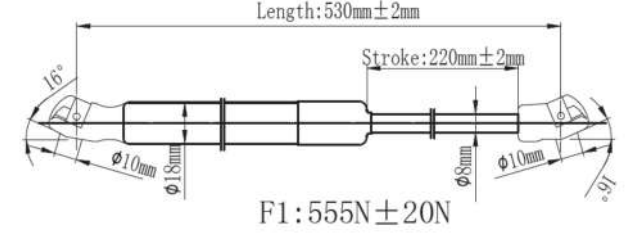

| | | |
|------------|----------|----------|
| Japanparts | Ashika | Japko |
| ZS10033 | ZSA10033 | ZSJ10033 |

O. E. M.: 9045073R00

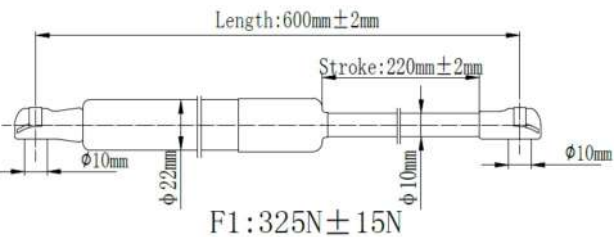

| | | |
|------------|----------|----------|
| Japanparts | Ashika | Japko |
| ZS10034 | ZSA10034 | ZSJ10034 |

O. E. M.: 90450-BM400

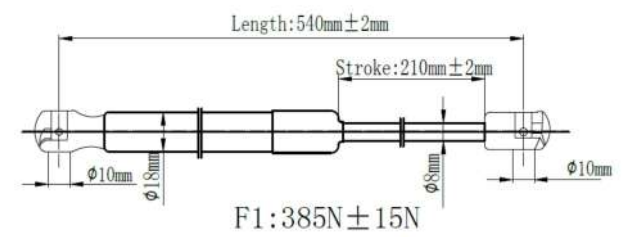

| | | |
|------------|----------|----------|
| Japanparts | Ashika | Japko |
| ZS10035 | ZSA10035 | ZSJ10035 |

O. E. M.: 9045055A10

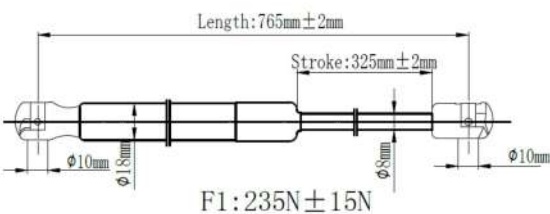

| | | |
|------------|----------|----------|
| Japanparts | Ashika | Japko |
| ZS10036 | ZSA10036 | ZSJ10036 |

O. E. M.: 904509C004

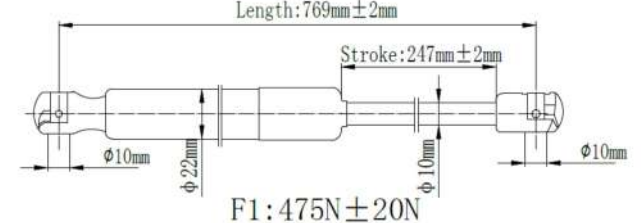

| | | |
|------------|----------|----------|
| Japanparts | Ashika | Japko |
| ZS10037 | ZSA10037 | ZSJ10037 |

O. E. M.: 904600W001

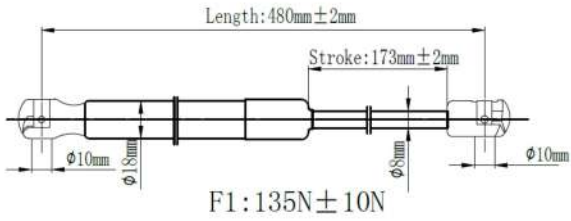

| | | |
|------------|----------|----------|
| Japanparts | Ashika | Japko |
| ZS10038 | ZSA10038 | ZSJ10038 |

O. E. M.: 653203G400

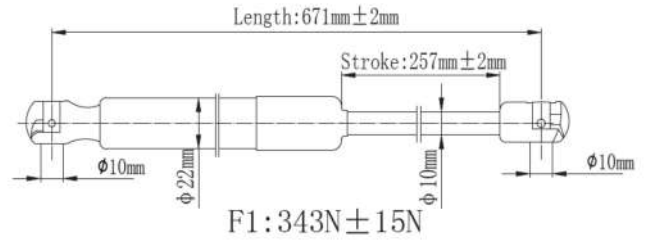

| | | |
|------------|----------|----------|
| Japanparts | Ashika | Japko |
| ZS10039 | ZSA10039 | ZSJ10039 |

O. E. M.: 654707Y010

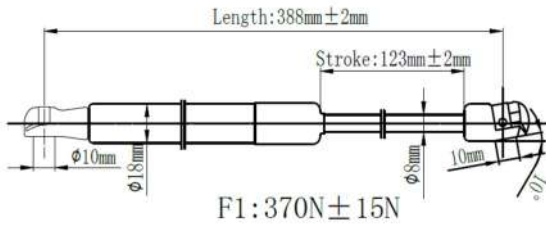

| | | |
|------------|----------|----------|
| Japanparts | Ashika | Japko |
| ZS10040 | ZSA10040 | ZSJ10040 |

O. E. M.: 844307Y000

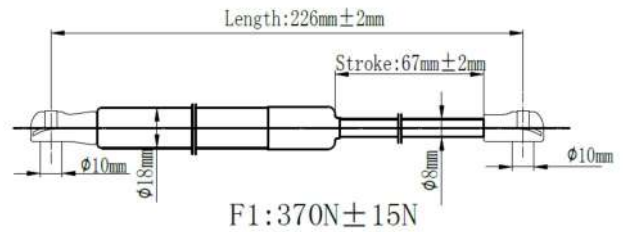

| | | |
|------------|----------|----------|
| Japanparts | Ashika | Japko |
| ZS10041 | ZSA10041 | ZSJ10041 |

O. E. M.: 844309N00A

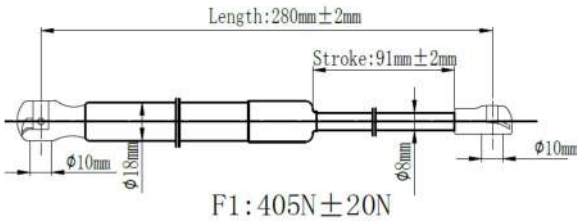

| | | |
|------------|----------|----------|
| Japanparts | Ashika | Japko |
| ZS10042 | ZSA10042 | ZSJ10042 |

O. E. M.: 84430JB100

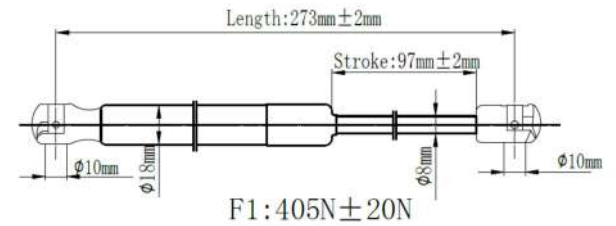

| | | |
|------------|----------|----------|
| Japanparts | Ashika | Japko |
| ZS10043 | ZSA10043 | ZSJ10043 |

O. E. M.: 9045011A01

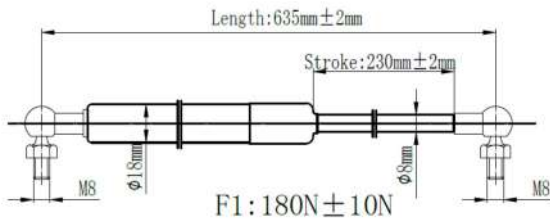

| | | |
|------------|----------|----------|
| Japanparts | Ashika | Japko |
| ZS10044 | ZSA10044 | ZSJ10044 |

O. E. M.: 904501KA0A

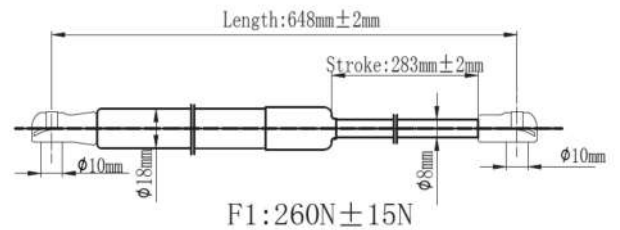

| | | |
|------------|----------|----------|
| Japanparts | Ashika | Japko |
| ZS10045 | ZSA10045 | ZSJ10045 |

O. E. M.: 904501VK0B

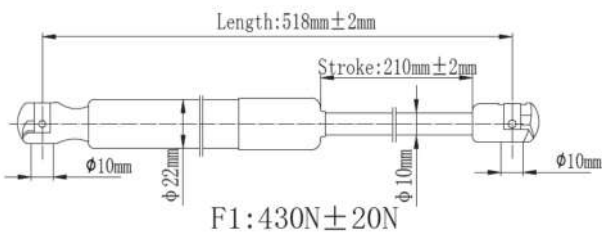

| | | |
|------------|----------|----------|
| Japanparts | Ashika | Japko |
| ZS10046 | ZSA10046 | ZSJ10046 |

O. E. M.: 9045050M00

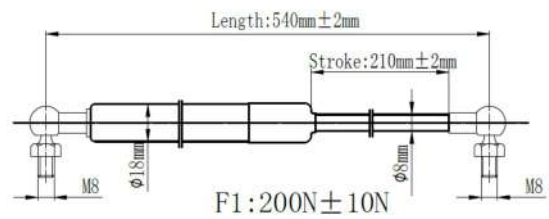

| | | |
|------------|----------|----------|
| Japanparts | Ashika | Japko |
| ZS10047 | ZSA10047 | ZSJ10047 |

O. E. M.: 904507Z002

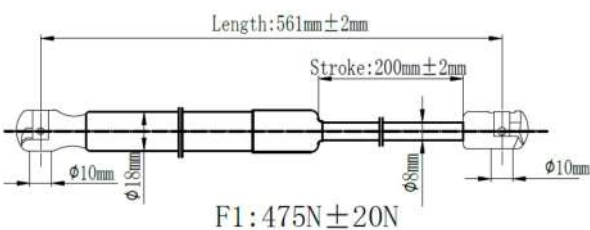

| | | |
|------------|----------|----------|
| Japanparts | Ashika | Japko |
| ZS10048 | ZSA10048 | ZSJ10048 |

O. E. M.: 90450D5500

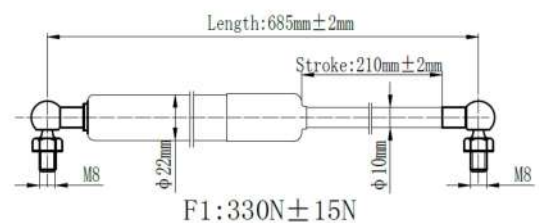

| | | |
|------------|----------|----------|
| Japanparts | Ashika | Japko |
| ZS10049 | ZSA10049 | ZSJ10049 |

O. E. M.: 9045100QAA

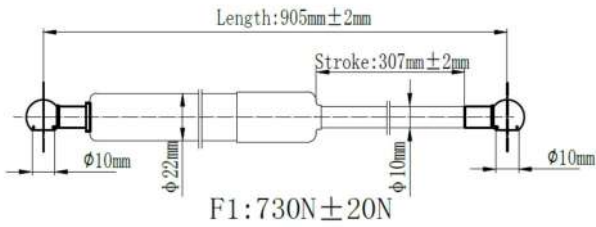

| | | |
|------------|----------|----------|
| Japanparts | Ashika | Japko |
| ZS10050 | ZSA10050 | ZSJ10050 |

O. E. M.: 1Q0827550B

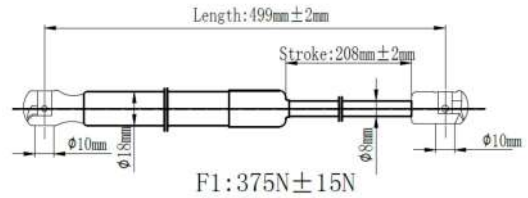

| | | |
|------------|----------|----------|
| Japanparts | Ashika | Japko |
| ZS10051 | ZSA10051 | ZSJ10051 |

O. E. M.: 65470CG000

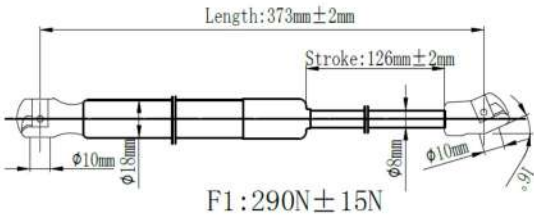

| | | |
|------------|----------|----------|
| Japanparts | Ashika | Japko |
| ZS10052 | ZSA10052 | ZSJ10052 |

O. E. M.: 65470JL00A

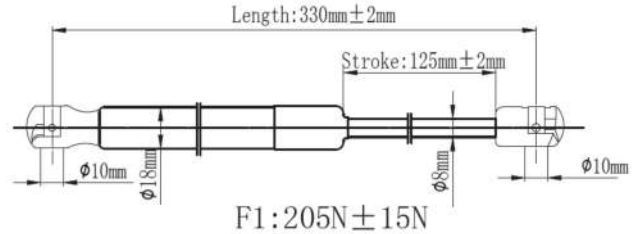

| | | |
|------------|----------|----------|
| Japanparts | Ashika | Japko |
| ZS10053 | ZSA10053 | ZSJ10053 |

O. E. M.: 654712Y010

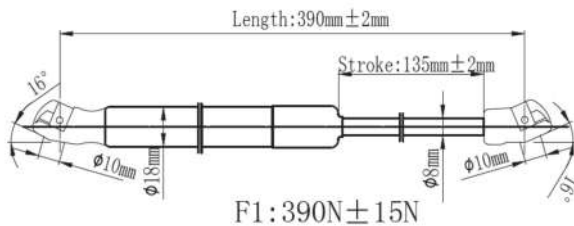

| | | |
|------------|----------|----------|
| Japanparts | Ashika | Japko |
| ZS10054 | ZSA10054 | ZSJ10054 |

O. E. M.: 904607S000

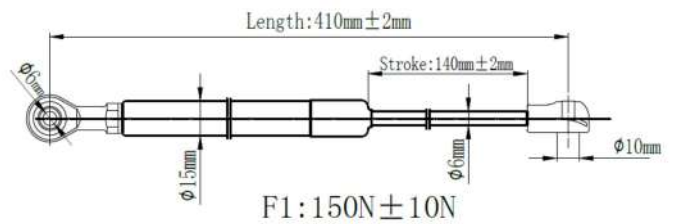

| | | |
|------------|----------|----------|
| Japanparts | Ashika | Japko |
| ZS10055 | ZSA10055 | ZSJ10055 |

O. E. M.: 65470JK00C

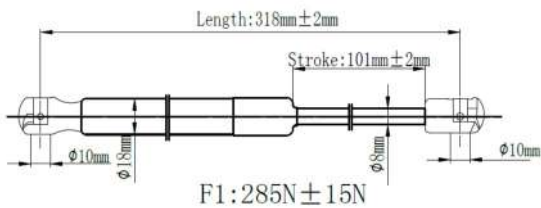

| | | |
|------------|----------|----------|
| Japanparts | Ashika | Japko |
| ZS10056 | ZSA10056 | ZSJ10056 |

O. E. M.: 84430AL525

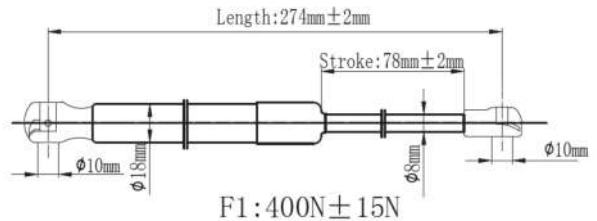

| | | |
|------------|----------|----------|
| Japanparts | Ashika | Japko |
| ZS20000 | ZSA20000 | ZSJ20000 |

O. E. M.: 689500W091

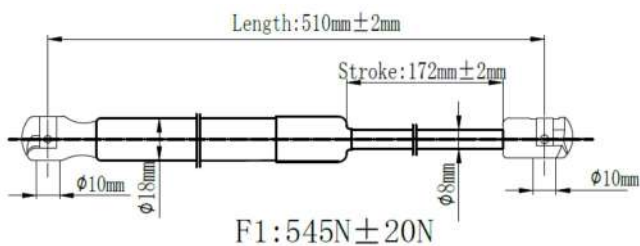

| | | |
|------------|----------|----------|
| Japanparts | Ashika | Japko |
| ZS20001 | ZSA20001 | ZSJ20001 |

O. E. M.: 6890795J14

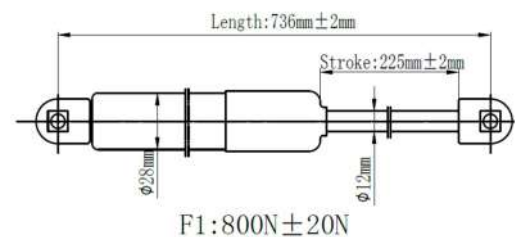

| | | |
|------------|----------|----------|
| Japanparts | Ashika | Japko |
| ZS20002 | ZSA20002 | ZSJ20002 |

O. E. M.: 6895002070

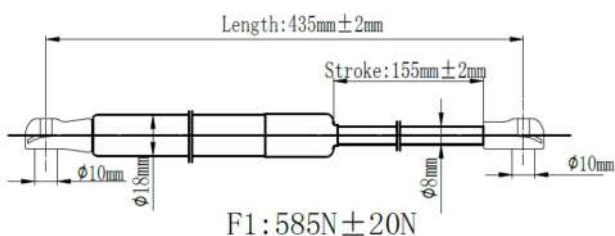

| | | |
|------------|----------|----------|
| Japanparts | Ashika | Japko |
| ZS20003 | ZSA20003 | ZSJ20003 |

O. E. M.: 6895005050

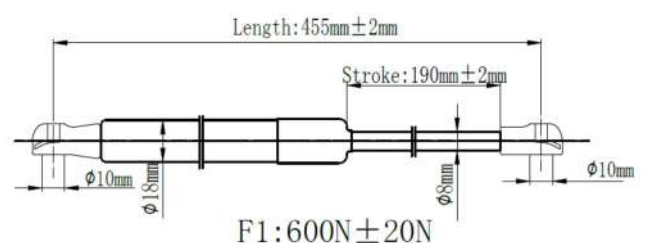

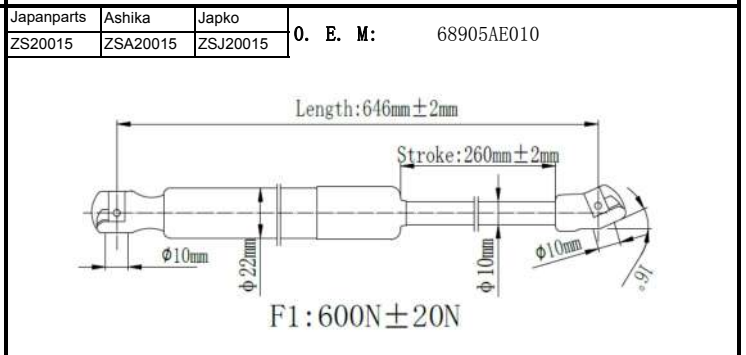
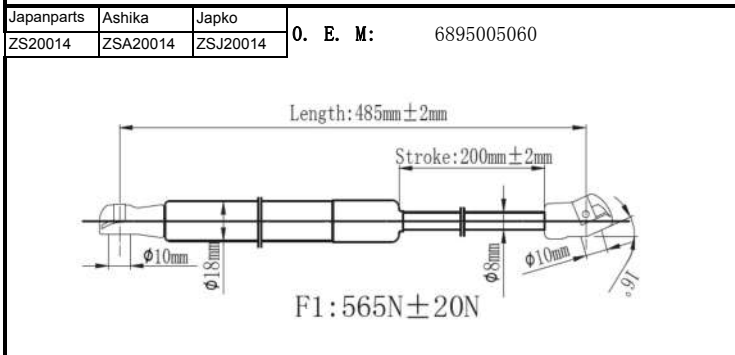
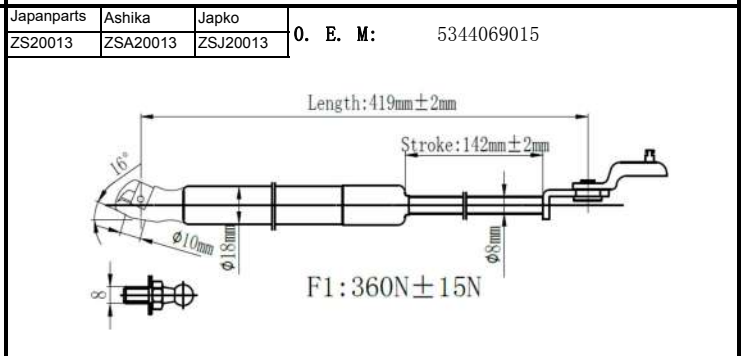
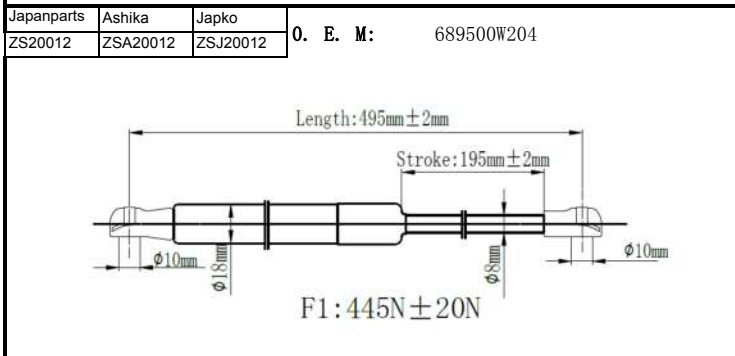
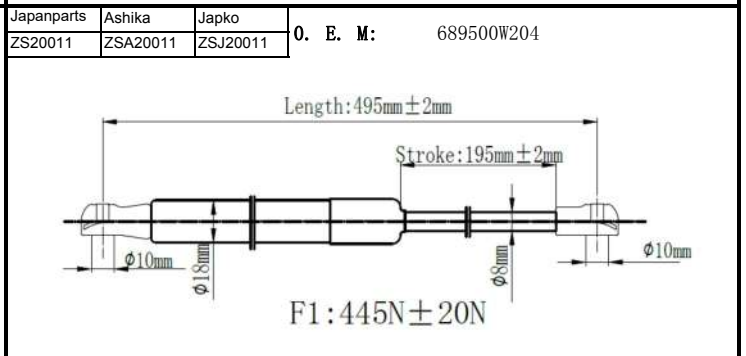
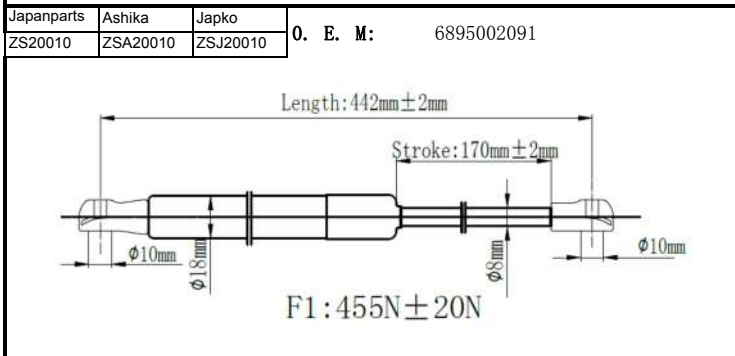
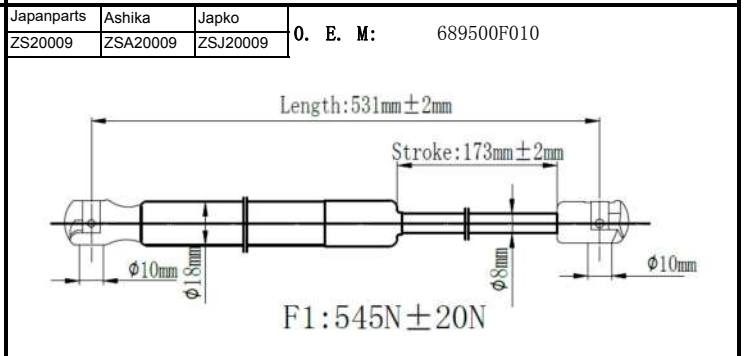
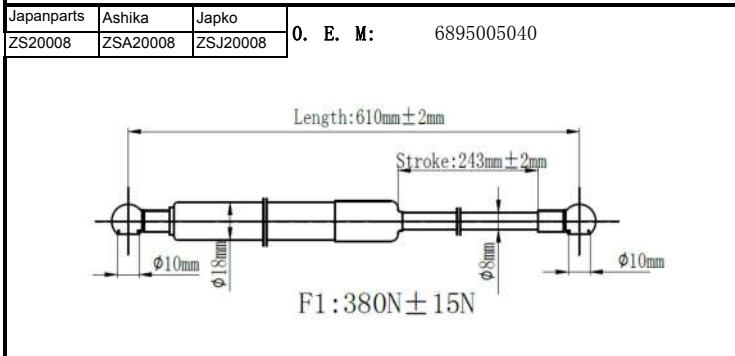
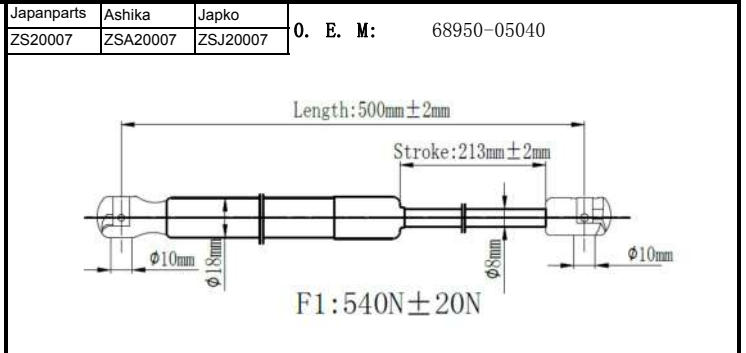
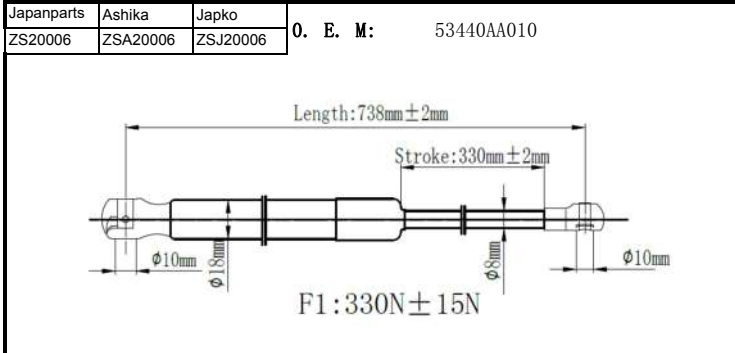
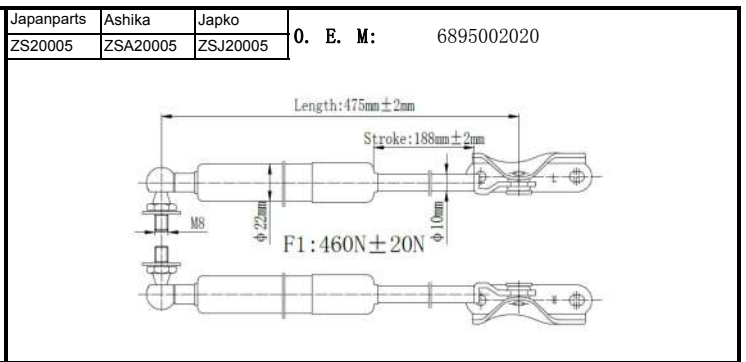
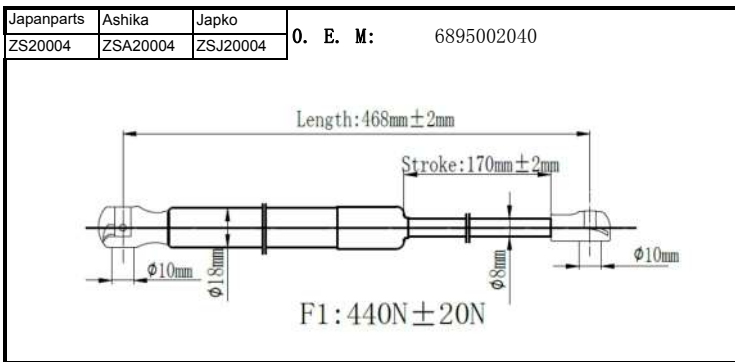

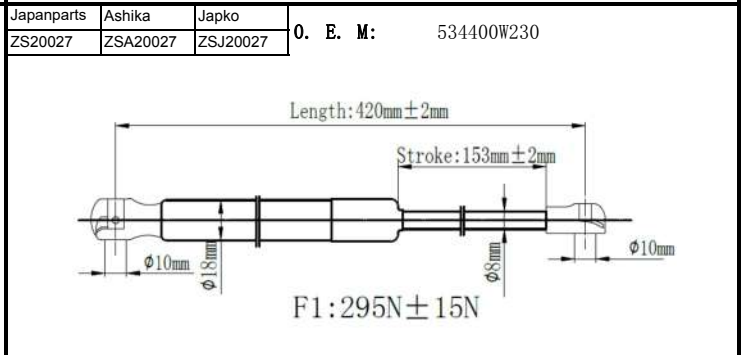
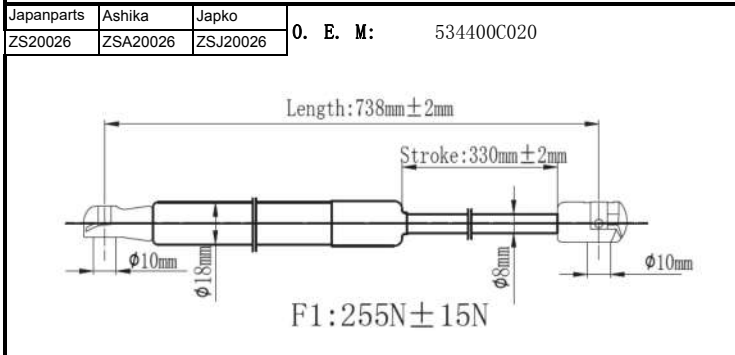
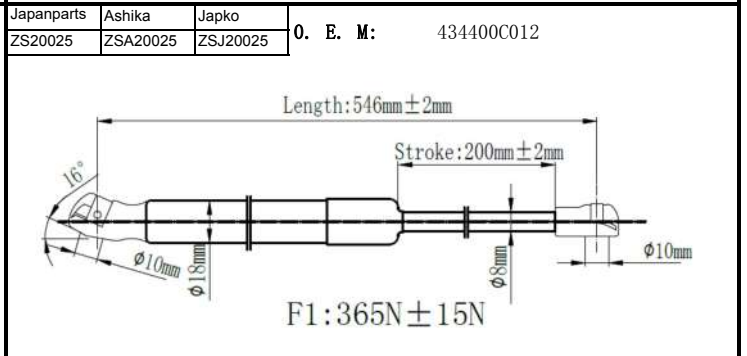
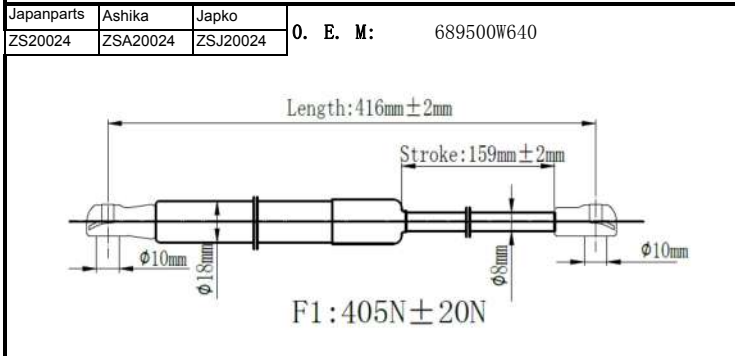
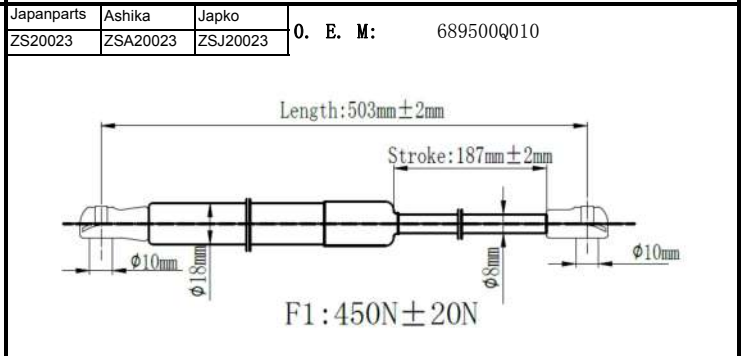
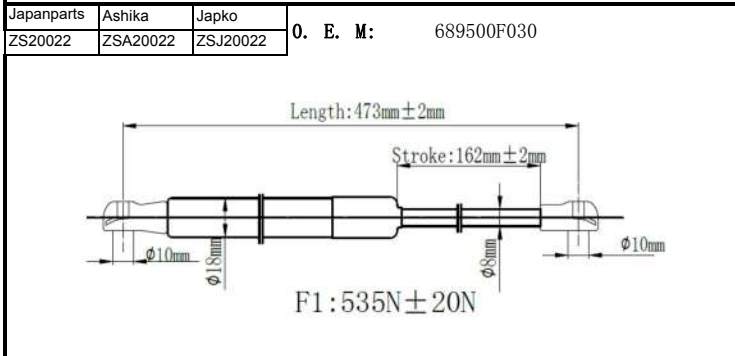
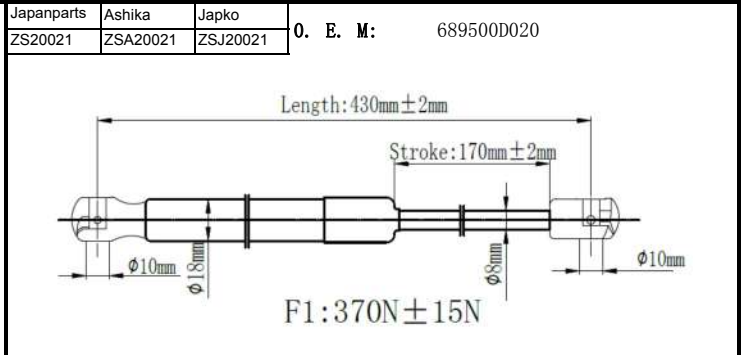
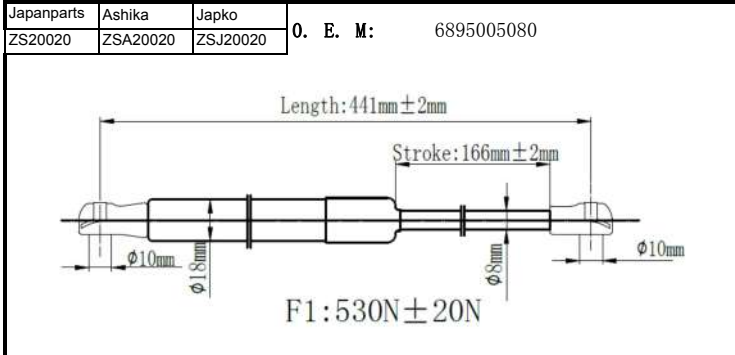
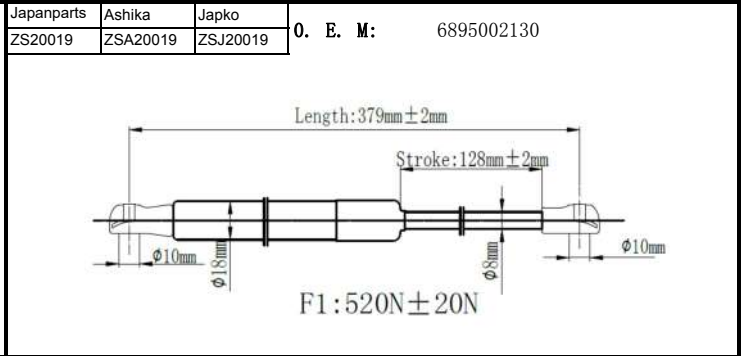
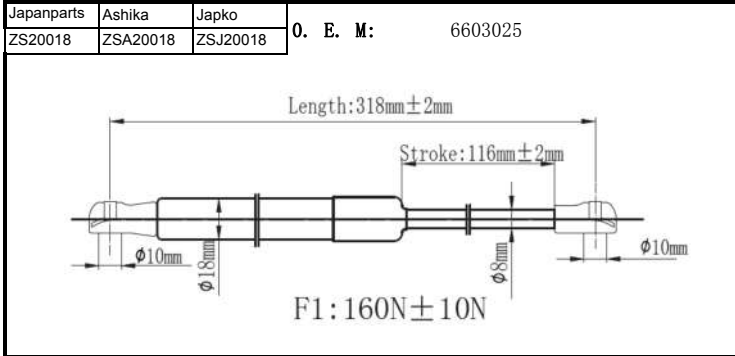
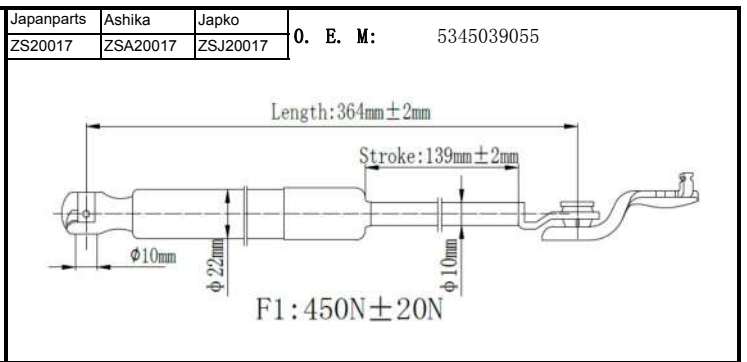
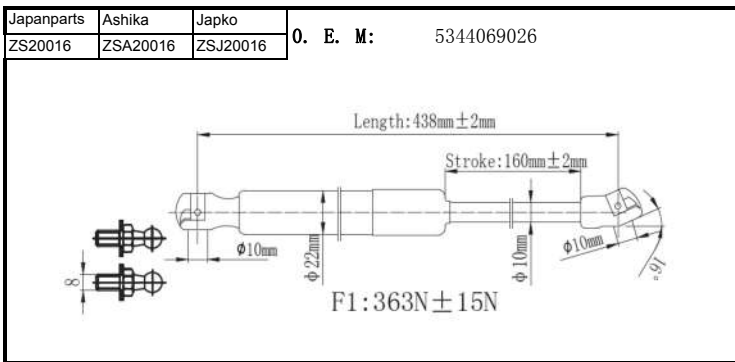

| | | |
|------------|----------|----------|
| Japanparts | Ashika | Japko |
| ZS20028 | ZSA20028 | ZSJ20028 |

O. E. M.: 68905AE011

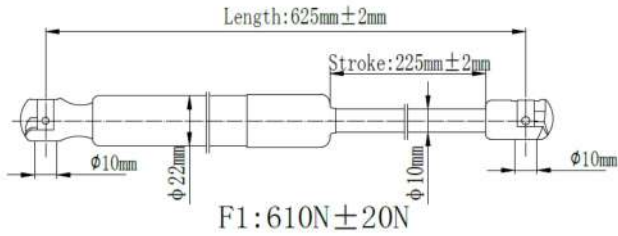

| | | |
|------------|----------|----------|
| Japanparts | Ashika | Japko |
| ZS20029 | ZSA20029 | ZSJ20029 |

O. E. M.: 689300W010

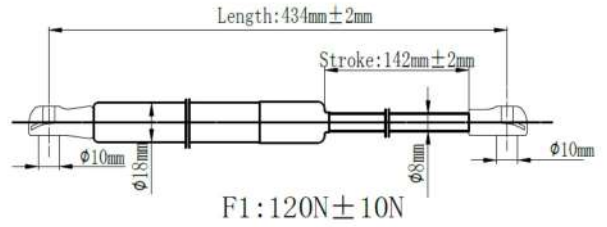

| | | |
|------------|----------|----------|
| Japanparts | Ashika | Japko |
| ZS20030 | ZSA20030 | ZSJ20030 |

O. E. M.: 689500T010A

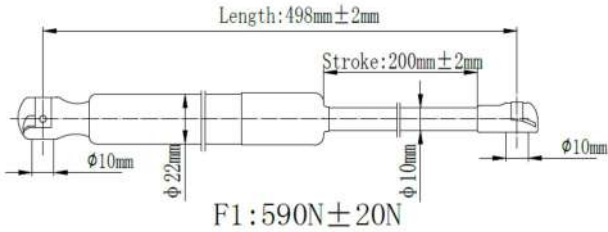

| | | |
|------------|----------|----------|
| Japanparts | Ashika | Japko |
| ZS20031 | ZSA20031 | ZSJ20031 |

O. E. M.: 534400W100

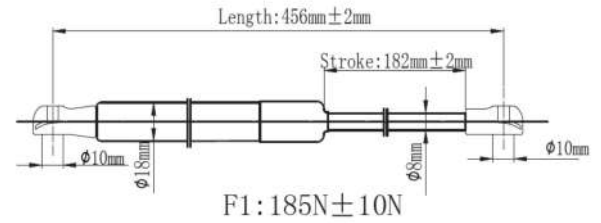

| | | |
|------------|----------|----------|
| Japanparts | Ashika | Japko |
| ZS20032 | ZSA20032 | ZSJ20032 |

O. E. M.: 534400W220

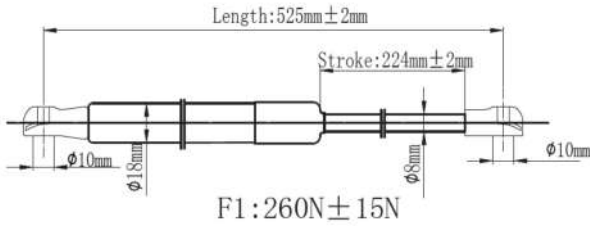

| | | |
|------------|----------|----------|
| Japanparts | Ashika | Japko |
| ZS20033 | ZSA20033 | ZSJ20033 |

O. E. M.: 534400W090

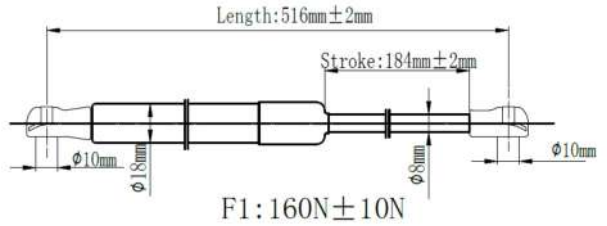

| | | |
|------------|----------|----------|
| Japanparts | Ashika | Japko |
| ZS20034 | ZSA20034 | ZSJ20034 |

O. E. M.: 645300W091

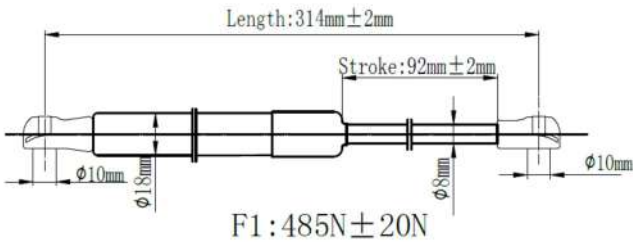

| | | |
|------------|----------|----------|
| Japanparts | Ashika | Japko |
| ZS20035 | ZSA20035 | ZSJ20035 |

O. E. M.: 534500W100

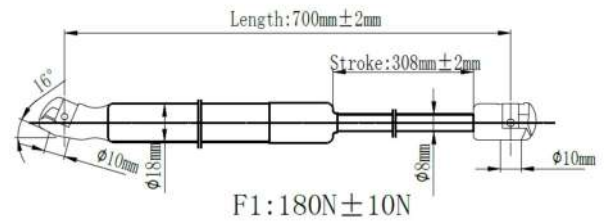

| | | |
|------------|----------|----------|
| Japanparts | Ashika | Japko |
| ZS20036 | ZSA20036 | ZSJ20036 |

O. E. M.: 5344050070

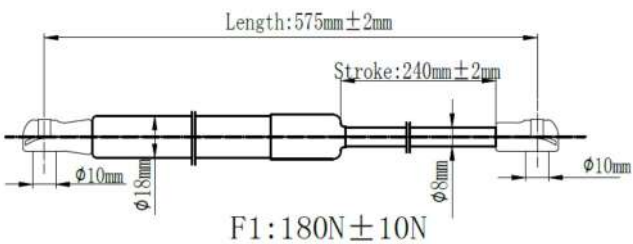

| | | |
|------------|----------|----------|
| Japanparts | Ashika | Japko |
| ZS20037 | ZSA20037 | ZSJ20037 |

O. E. M.: 5344059115

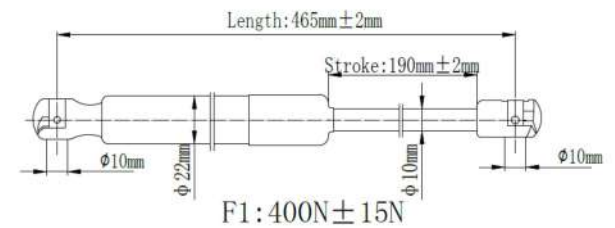

| | | |
|------------|----------|----------|
| Japanparts | Ashika | Japko |
| ZS20038 | ZSA20038 | ZSJ20038 |

O. E. M.: 534400W040

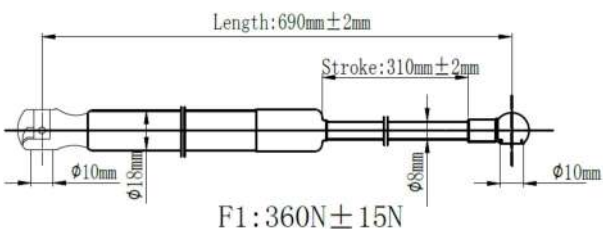

| | | |
|------------|----------|----------|
| Japanparts | Ashika | Japko |
| ZS20039 | ZSA20039 | ZSJ20039 |

O. E. M.:

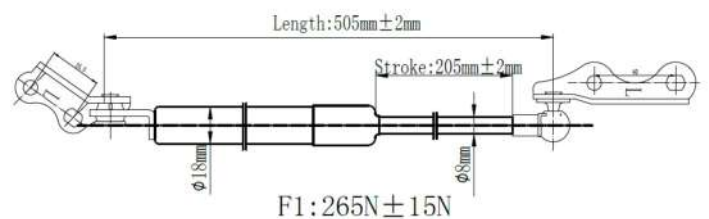

| | | |
|------------|----------|----------|
| Japanparts | Ashika | Japko |
| ZS20040 | ZSA20040 | ZSJ20040 |

O. E. M: 53440-69055

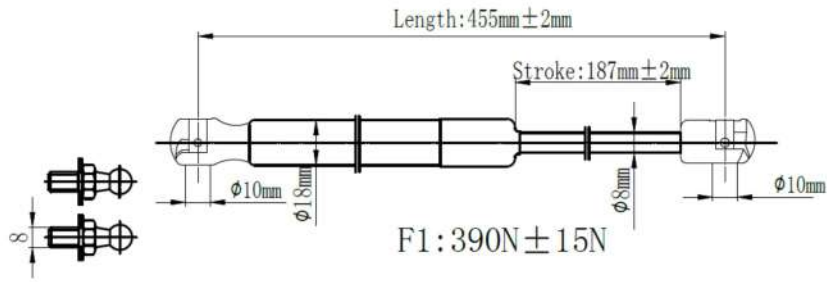

| | | |
|------------|----------|----------|
| Japanparts | Ashika | Japko |
| ZS20041 | ZSA20041 | ZSJ20041 |

O. E. M: 689500W560

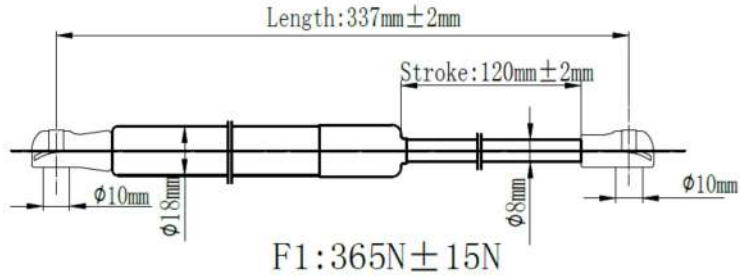

| | | |
|------------|----------|----------|
| Japanparts | Ashika | Japko |
| ZS20044 | ZSA20044 | ZSJ20044 |

O. E. M: 6895009111

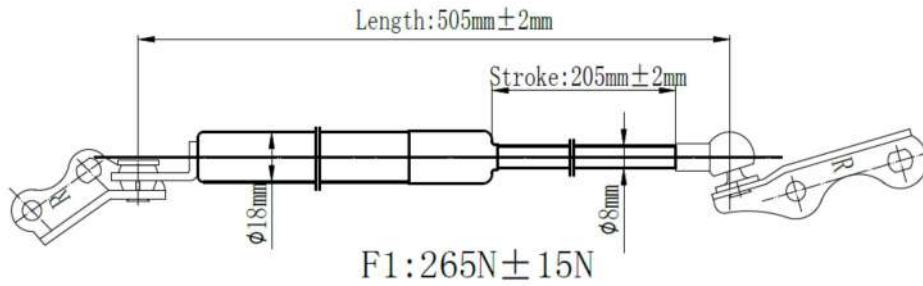

| | | |
|------------|----------|----------|
| Japanparts | Ashika | Japko |
| ZS20045 | ZSA20045 | ZSJ20045 |

O. E. M: 68950-0H030

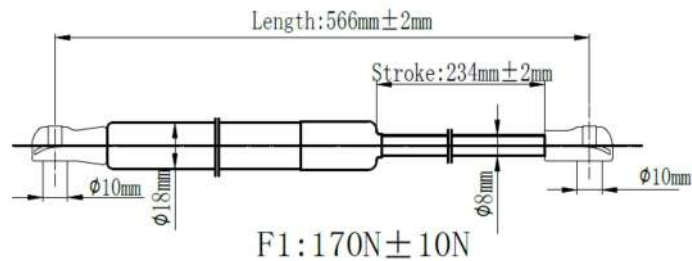

| | | |
|------------|----------|----------|
| Japanparts | Ashika | Japko |
| ZS20049 | ZSA20049 | ZSJ20049 |

O. E. M: 6895005925

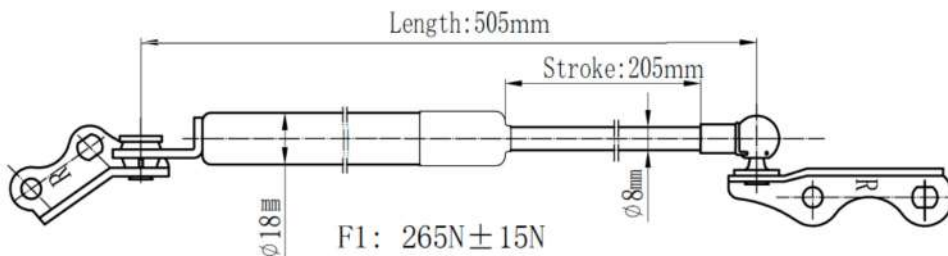

| | | |
|------------|----------|----------|
| Japanparts | Ashika | Japko |
| ZS30000 | ZSA30000 | ZSJ30000 |

O. E. M: B25R62620C

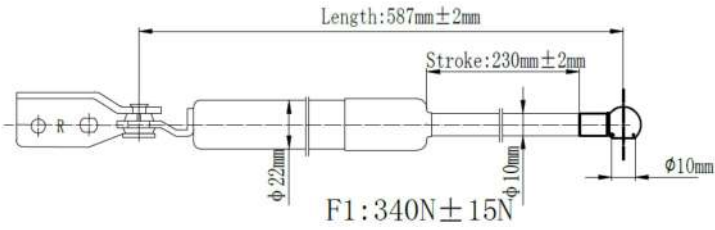

| | | |
|------------|----------|----------|
| Japanparts | Ashika | Japko |
| ZS30001 | ZSA30001 | ZSJ30001 |

O. E. M: GE4V63620C

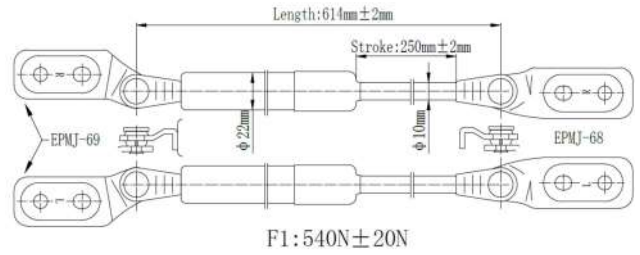

| | | |
|------------|----------|----------|
| Japanparts | Ashika | Japko |
| ZS30002 | ZSA30002 | ZSJ30002 |

O. E. M: BP4K62620D

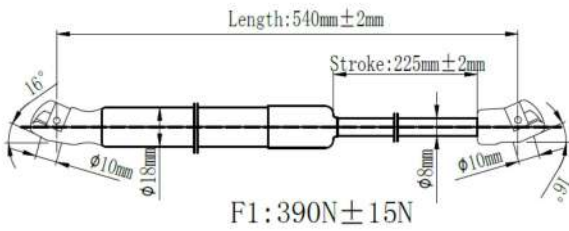

| | | |
|------------|----------|----------|
| Japanparts | Ashika | Japko |
| ZS30003 | ZSA30003 | ZSJ30003 |

O. E. M: 0

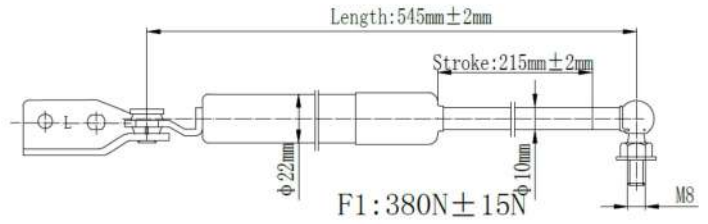

| | | |
|------------|----------|----------|
| Japanparts | Ashika | Japko |
| ZS30004 | ZSA30004 | ZSJ30004 |

O. E. M: GJ6A56930

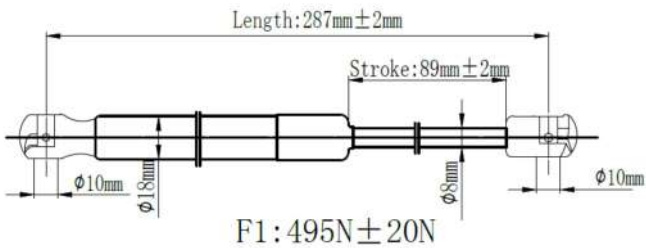

| | | |
|------------|----------|----------|
| Japanparts | Ashika | Japko |
| ZS30005 | ZSA30005 | ZSJ30005 |

O. E. M: G21B62620B

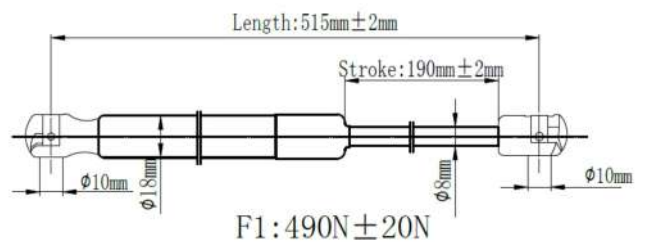

| | | |
|------------|----------|----------|
| Japanparts | Ashika | Japko |
| ZS30006 | ZSA30006 | ZSJ30006 |

O. E. M: GJ6J62620

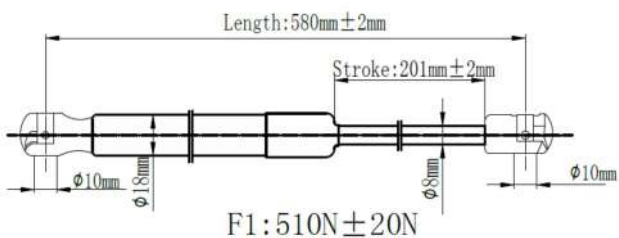

| | | |
|------------|----------|----------|
| Japanparts | Ashika | Japko |
| ZS30007 | ZSA30007 | ZSJ30007 |

O. E. M: BN8V56930

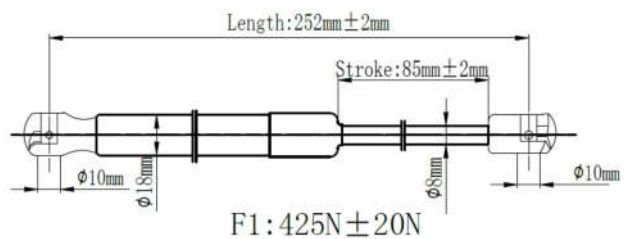

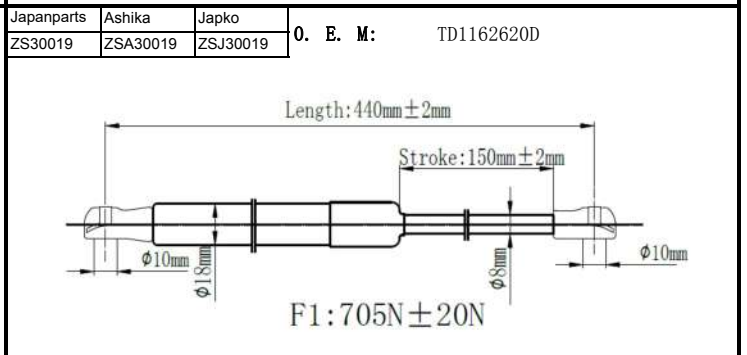
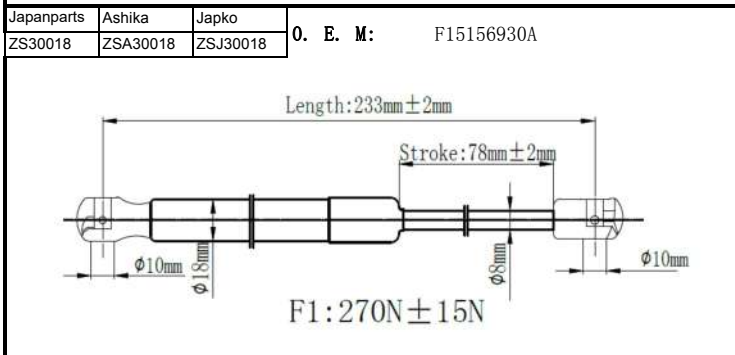
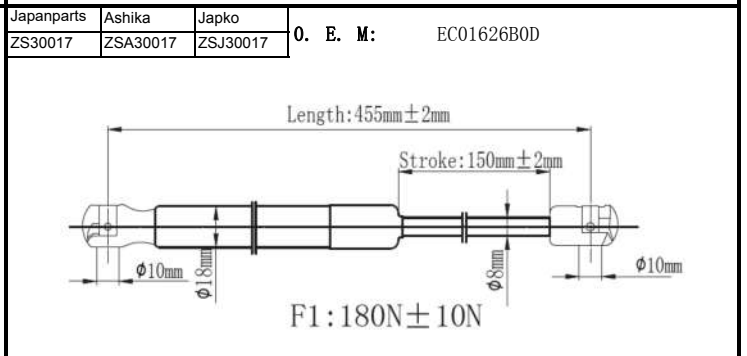
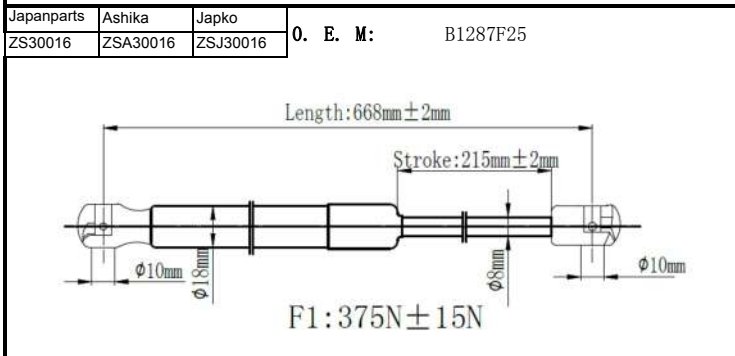
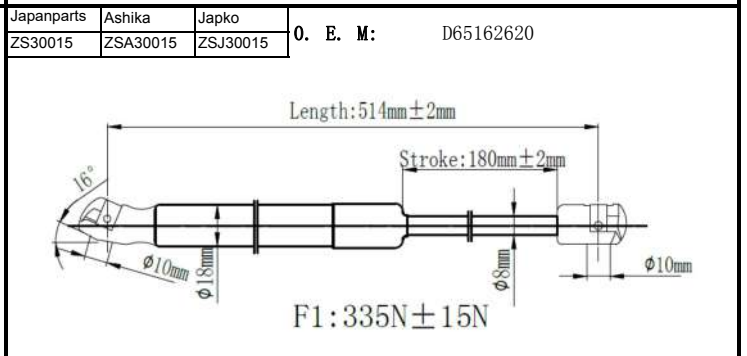
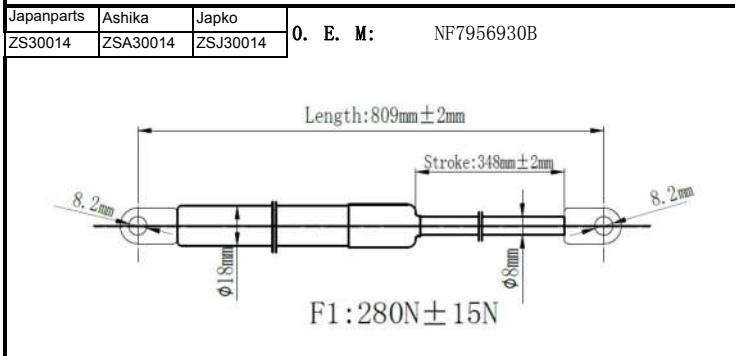
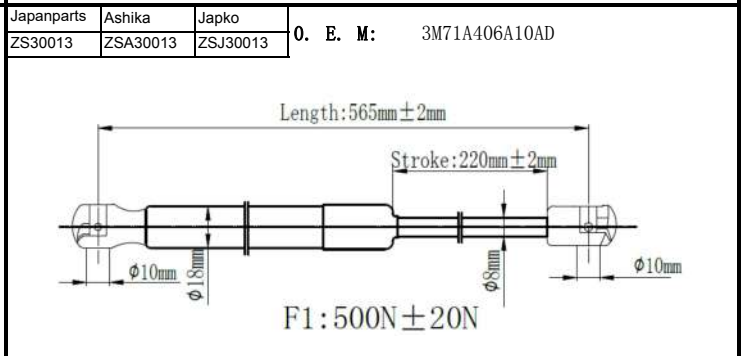
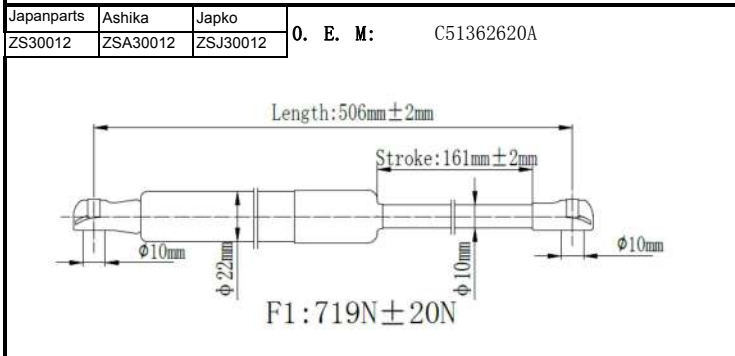
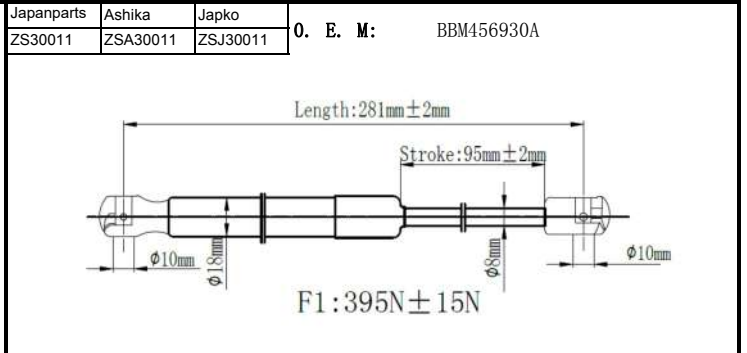
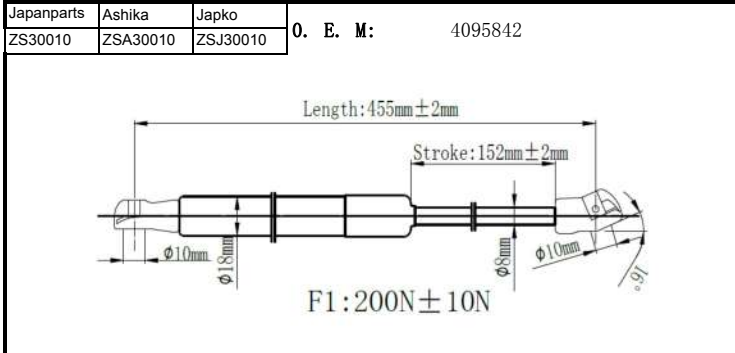
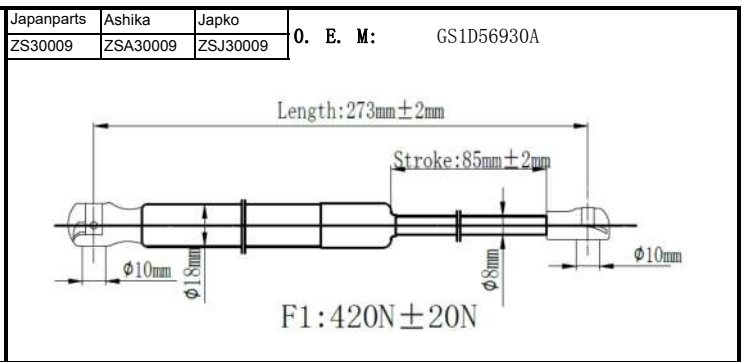
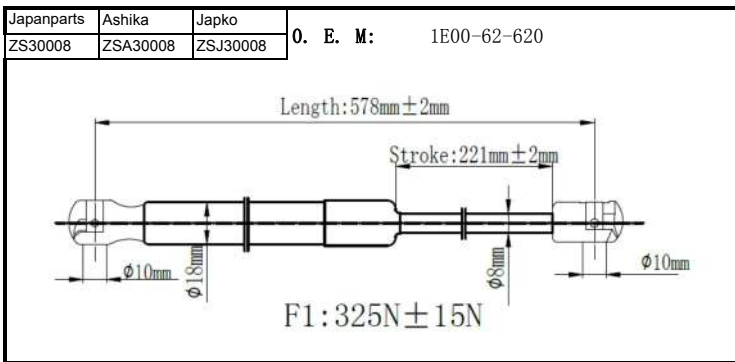

| | | |
|------------|----------|----------|
| Japanparts | Ashika | Japko |
| ZS30020 | ZSA30020 | ZSJ30020 |

O. E. M.: TD1262620D

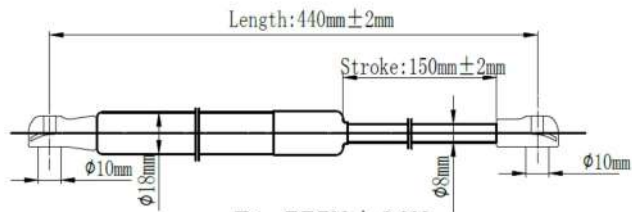

F1: 775N ± 20N

| | | |
|------------|----------|----------|
| Japanparts | Ashika | Japko |
| ZS40000 | ZSA40000 | ZSJ40000 |

O. E. M.: 74820TL4G01

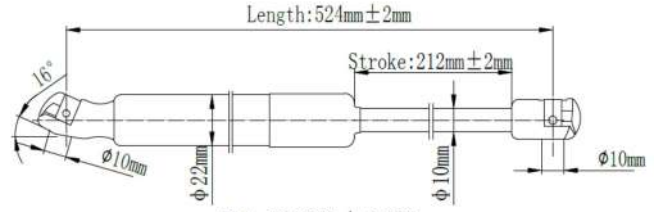

F1: 540N ± 20N

| | | |
|------------|----------|----------|
| Japanparts | Ashika | Japko |
| ZS40001 | ZSA40001 | ZSJ40001 |

O. E. M.: 74145S3MA00

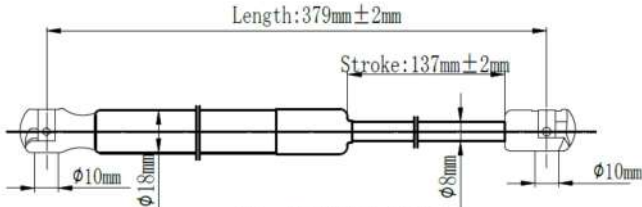

F1: 378N ± 15N

| | | |
|------------|----------|----------|
| Japanparts | Ashika | Japko |
| ZS40002 | ZSA40002 | ZSJ40002 |

O. E. M.: 74145S3VA01

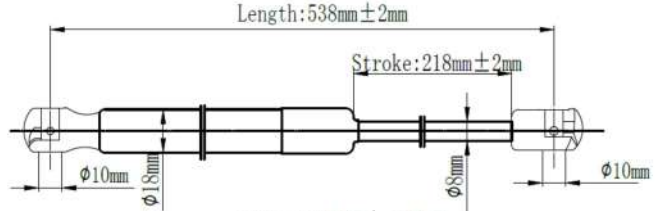

F1: 170N ± 10N

| | | |
|------------|----------|----------|
| Japanparts | Ashika | Japko |
| ZS40003 | ZSA40003 | ZSJ40003 |

O. E. M.:

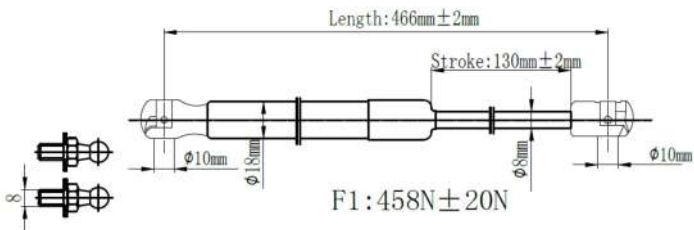

F1: 458N ± 20N

| | | |
|------------|----------|----------|
| Japanparts | Ashika | Japko |
| ZS40004 | ZSA40004 | ZSJ40004 |

O. E. M.: 74145TK4A01

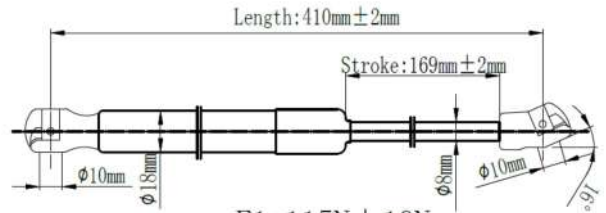

F1: 115N ± 10N

| | | |
|------------|----------|----------|
| Japanparts | Ashika | Japko |
| ZS40005 | ZSA40005 | ZSJ40005 |

O. E. M.: 74820SK7A02

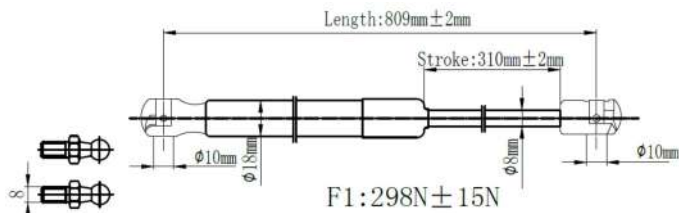

F1: 298N ± 15N

| | | |
|------------|----------|----------|
| Japanparts | Ashika | Japko |
| ZS40006 | ZSA40006 | ZSJ40006 |

O. E. M.: 74820ST7305

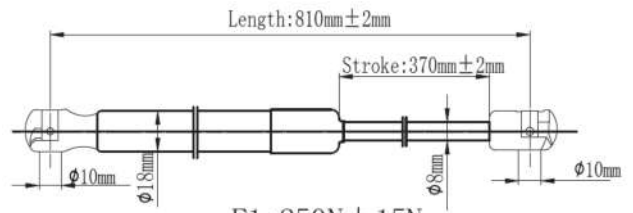

F1: 250N ± 15N

| | | |
|------------|----------|----------|
| Japanparts | Ashika | Japko |
| ZS40007 | ZSA40007 | ZSJ40007 |

O. E. M.: 74820ST7306

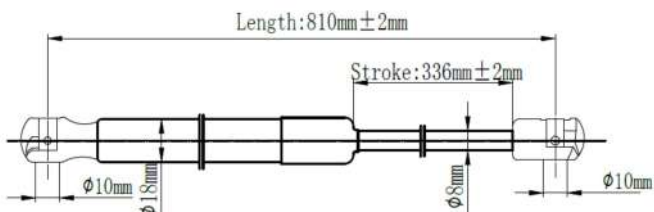

F1: 290N ± 15N

| | | |
|------------|----------|----------|
| Japanparts | Ashika | Japko |
| ZS40008 | ZSA40008 | ZSJ40008 |

O. E. M.: 74820S5SE01

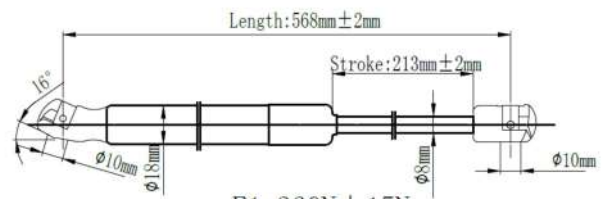

F1: 360N ± 15N

| | | |
|------------|----------|----------|
| Japanparts | Ashika | Japko |
| ZS40009 | ZSA40009 | ZSJ40009 |

O. E. M.: 74820SK3E20

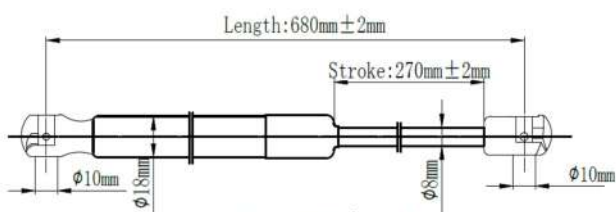

F1: 360N ± 15N

| | | |
|------------|----------|----------|
| Japanparts | Ashika | Japko |
| ZS40010 | ZSA40010 | ZSJ40010 |

O. E. M.: 04741S10000

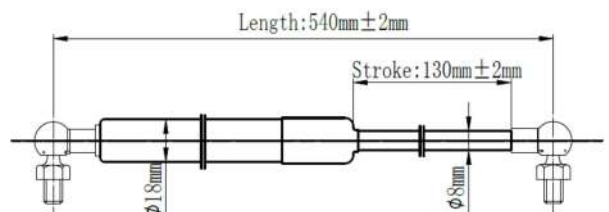

F1: 170N ± 10N

| | | |
|------------|----------|----------|
| Japanparts | Ashika | Japko |
| ZS40011 | ZSA40011 | ZSJ40011 |

O. E. M.: 0474-6S2H-000

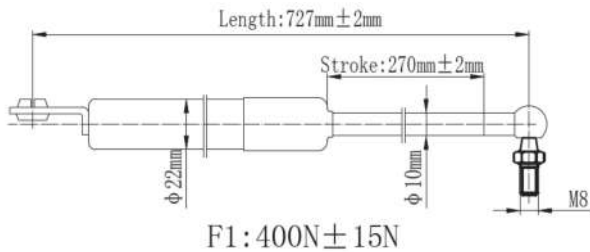

| | | |
|------------|----------|----------|
| Japanparts | Ashika | Japko |
| ZS40012 | ZSA40012 | ZSJ40012 |

O. E. M.: 74820S1EE01

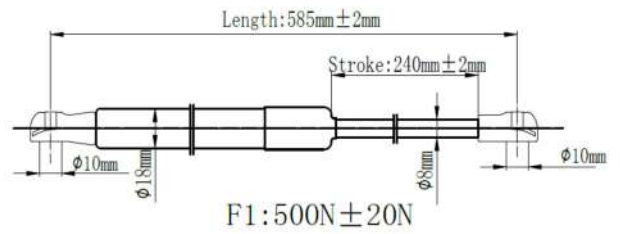

| | | |
|------------|----------|----------|
| Japanparts | Ashika | Japko |
| ZS40013 | ZSA40013 | ZSJ40013 |

O. E. M.: 74820S6DE01

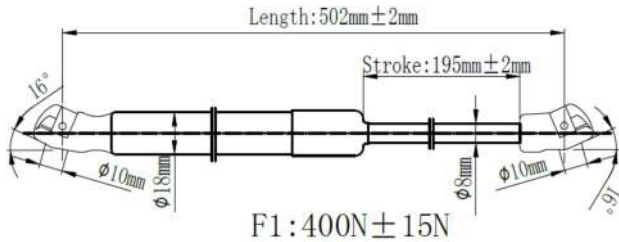

| | | |
|------------|----------|----------|
| Japanparts | Ashika | Japko |
| ZS40014 | ZSA40014 | ZSJ40014 |

O. E. M.: 04741SED000

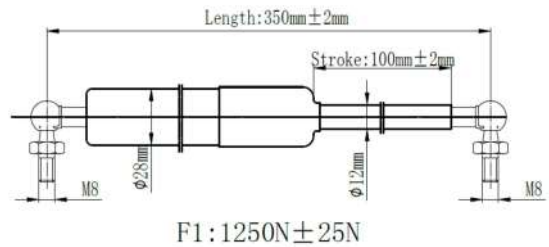

| | | |
|------------|----------|----------|
| Japanparts | Ashika | Japko |
| ZS40015 | ZSA40015 | ZSJ40015 |

O. E. M.: 74820SMGE01

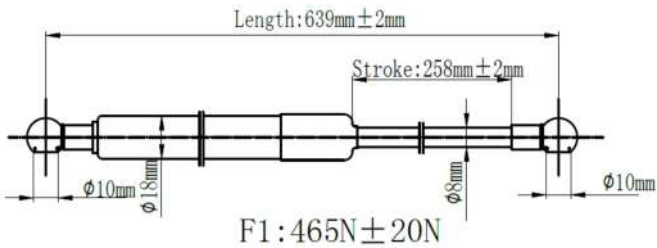

| | | |
|------------|----------|----------|
| Japanparts | Ashika | Japko |
| ZS40016 | ZSA40016 | ZSJ40016 |

O. E. M.: 74820S1CE01

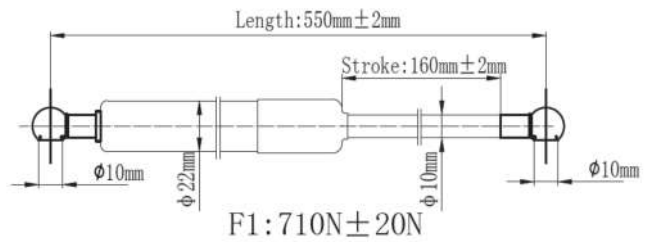

| | | |
|------------|----------|----------|
| Japanparts | Ashika | Japko |
| ZS40017 | ZSA40017 | ZSJ40017 |

O. E. M.: 74820SR2306

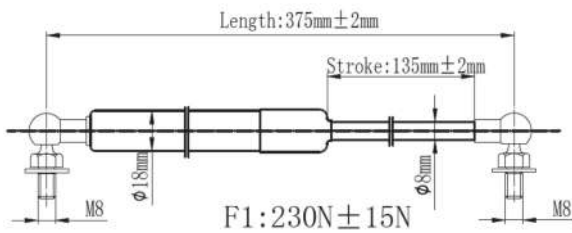

| | | |
|------------|----------|----------|
| Japanparts | Ashika | Japko |
| ZS40018 | ZSA40018 | ZSJ40018 |

O. E. M.: 74820T1GE010

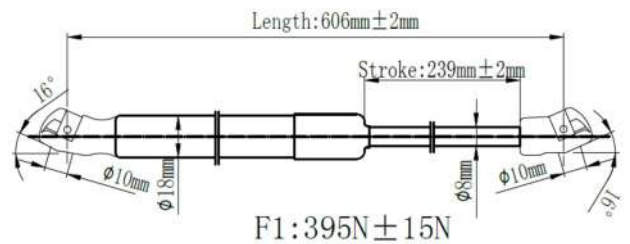

| | | |
|------------|----------|----------|
| Japanparts | Ashika | Japko |
| ZS40019 | ZSA40019 | ZSJ40019 |

O. E. M.: 74820S9VA01

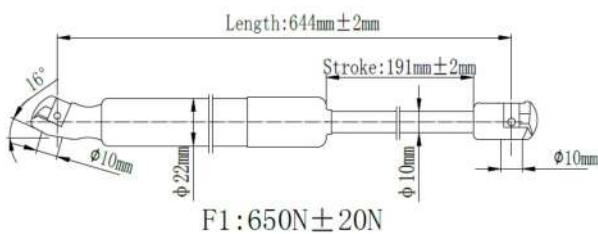

| | | |
|------------|----------|----------|
| Japanparts | Ashika | Japko |
| ZS40020 | ZSA40020 | ZSJ40020 |

O. E. M.: 74820S50G01

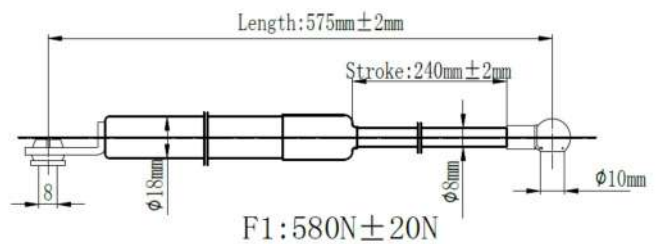

| | | |
|------------|----------|----------|
| Japanparts | Ashika | Japko |
| ZS40021 | ZSA40021 | ZSJ40021 |

O. E. M.: 74820TV0E011M1

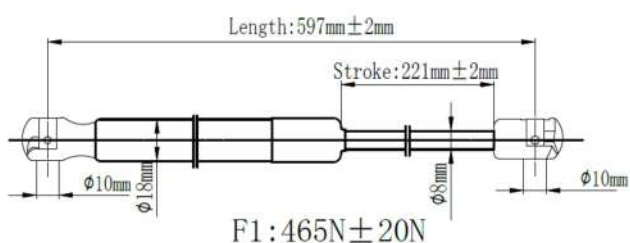

| | | |
|------------|----------|----------|
| Japanparts | Ashika | Japko |
| ZS40022 | ZSA40022 | ZSJ40022 |

O. E. M.: 74820SWAA01

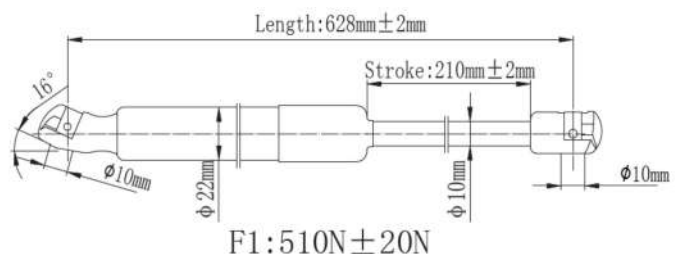

| | | |
|------------|----------|----------|
| Japanparts | Ashika | Japko |
| ZS40023 | ZSA40023 | ZSJ40023 |

O. E. M.: 74820TL4G31

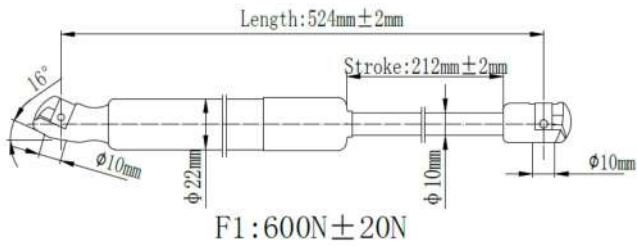

| | | |
|------------|----------|----------|
| Japanparts | Ashika | Japko |
| ZS40024 | ZSA40024 | ZSJ40024 |

O. E. M.: 74820SR3003

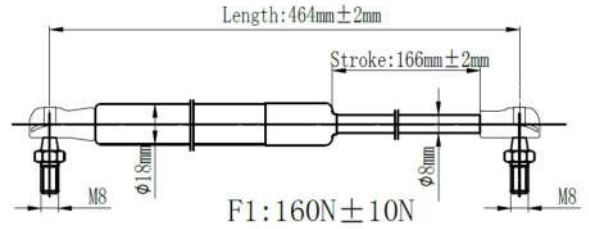

| | | |
|------------|----------|----------|
| Japanparts | Ashika | Japko |
| ZS40025 | ZSA40025 | ZSJ40025 |

O. E. M.: 74820SH3003

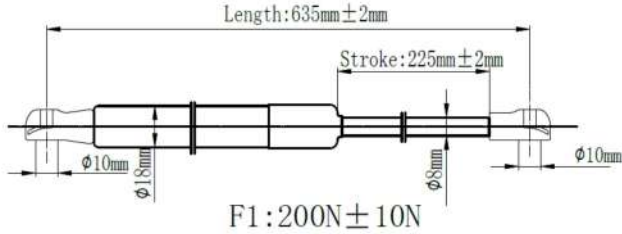

| | | |
|------------|----------|----------|
| Japanparts | Ashika | Japko |
| ZS40026 | ZSA40026 | ZSJ40026 |

O. E. M.: 74820SCVA01

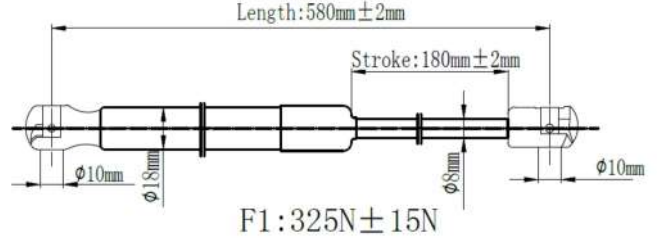

| | | |
|------------|----------|----------|
| Japanparts | Ashika | Japko |
| ZS40027 | ZSA40027 | ZSJ40027 |

O. E. M.: 74820SHJA01

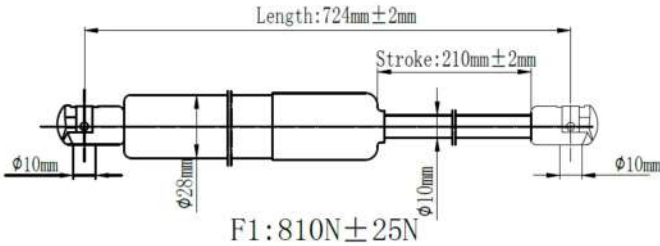

| | | |
|------------|----------|----------|
| Japanparts | Ashika | Japko |
| ZS40028 | ZSA40028 | ZSJ40028 |

O. E. M.: 74820ST3E01

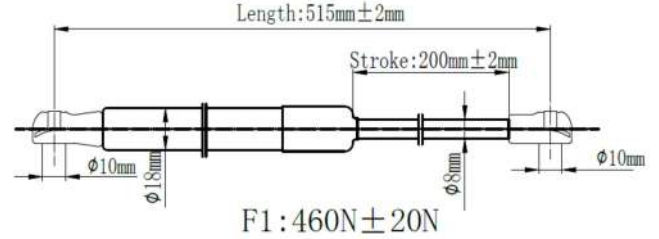

| | | |
|------------|----------|----------|
| Japanparts | Ashika | Japko |
| ZS40029 | ZSA40029 | ZSJ40029 |

O. E. M.: BHM160020

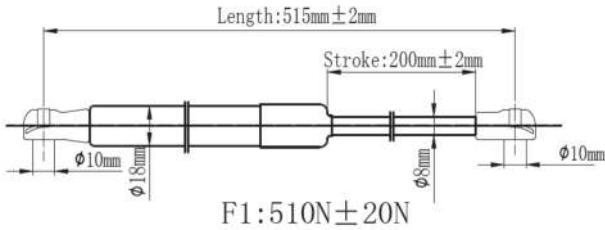

| | | |
|------------|----------|----------|
| Japanparts | Ashika | Japko |
| ZS40030 | ZSA40030 | ZSJ40030 |

O. E. M.: BHE45001

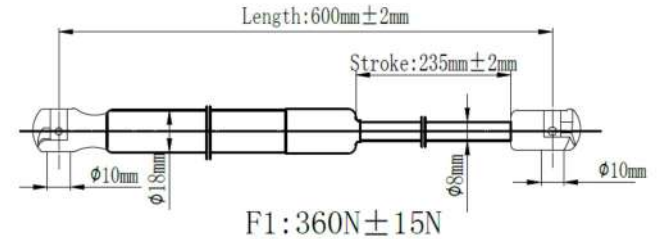

| | | |
|------------|----------|----------|
| Japanparts | Ashika | Japko |
| ZS40031 | ZSA40031 | ZSJ40031 |

O. E. M.: BKK500010

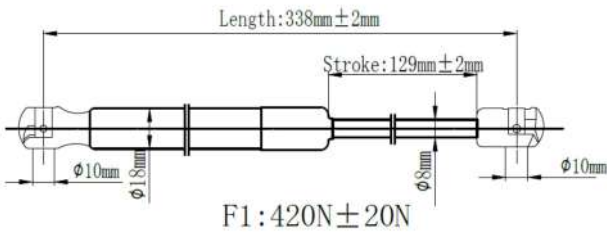

| | | |
|------------|----------|----------|
| Japanparts | Ashika | Japko |
| ZS40032 | ZSA40032 | ZSJ40032 |

O. E. M.: BHE500050

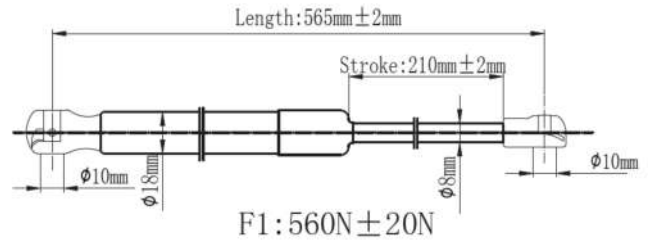

| | | |
|------------|----------|----------|
| Japanparts | Ashika | Japko |
| ZS40033 | ZSA40033 | ZSJ40033 |

O. E. M.: BMH500010

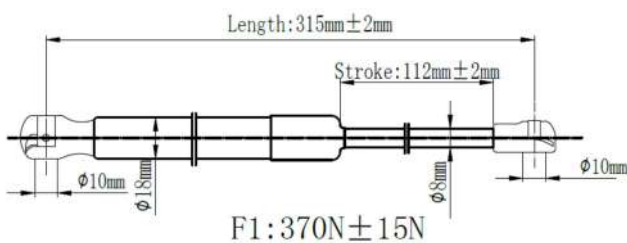

| | | |
|------------|----------|----------|
| Japanparts | Ashika | Japko |
| ZS40034 | ZSA40034 | ZSJ40034 |

O. E. M.: BHE500070

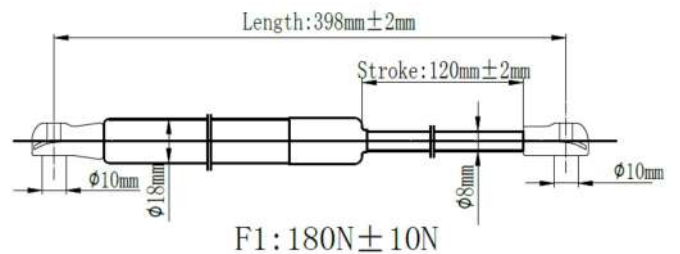

| | | |
|------------|----------|----------|
| Japanparts | Ashika | Japko |
| ZS40035 | ZSA40035 | ZSJ40035 |

O. E. M.: GST122

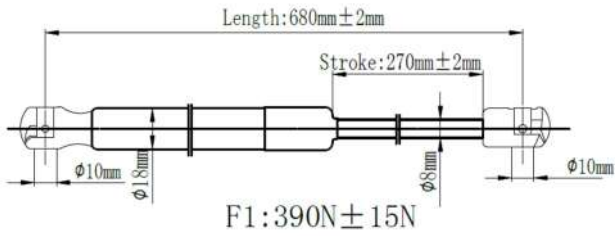

| | | |
|------------|----------|----------|
| Japanparts | Ashika | Japko |
| ZS40036 | ZSA40036 | ZSJ40036 |

O. E. M.: BHE41003

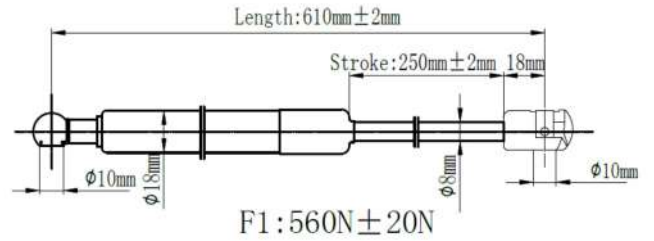

| | | |
|------------|----------|----------|
| Japanparts | Ashika | Japko |
| ZS40037 | ZSA40037 | ZSJ40037 |

O. E. M.: 393091

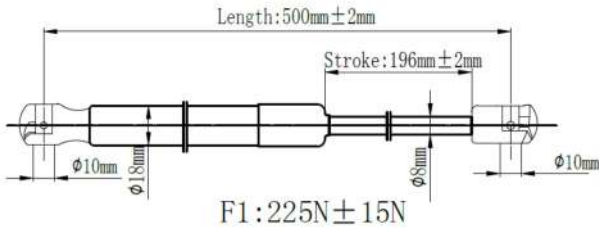

| | | |
|------------|----------|----------|
| Japanparts | Ashika | Japko |
| ZS40038 | ZSA40038 | ZSJ40038 |

O. E. M.: GST112

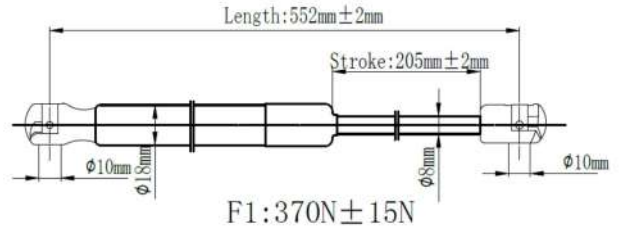

| | | |
|------------|----------|----------|
| Japanparts | Ashika | Japko |
| ZS40039 | ZSA40039 | ZSJ40039 |

O. E. M.: BHM410040

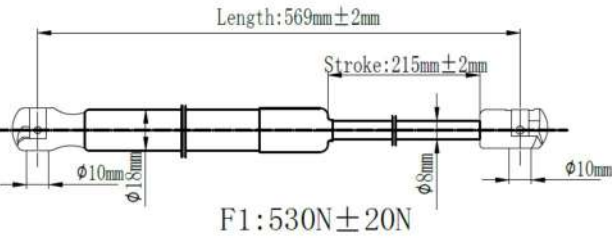

| | | |
|------------|----------|----------|
| Japanparts | Ashika | Japko |
| ZS40040 | ZSA40040 | ZSJ40040 |

O. E. M.: BKK41003

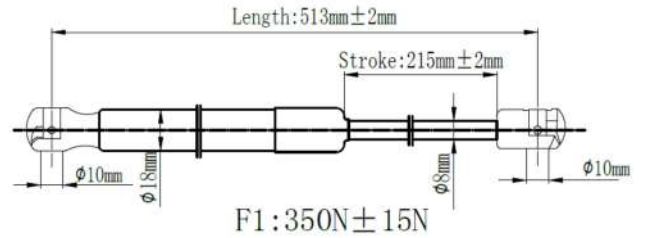

| | | |
|------------|----------|----------|
| Japanparts | Ashika | Japko |
| ZS40041 | ZSA40041 | ZSJ40041 |

O. E. M.: BEP6628

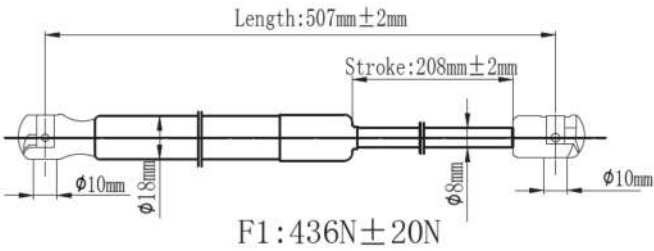

| | | |
|------------|----------|----------|
| Japanparts | Ashika | Japko |
| ZS40042 | ZSA40042 | ZSJ40042 |

O. E. M.: BMH38003

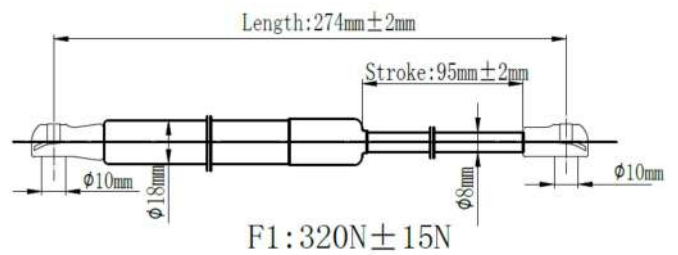

| | | |
|------------|----------|----------|
| Japanparts | Ashika | Japko |
| ZS40043 | ZSA40043 | ZSJ40043 |

O. E. M.: ADU6669

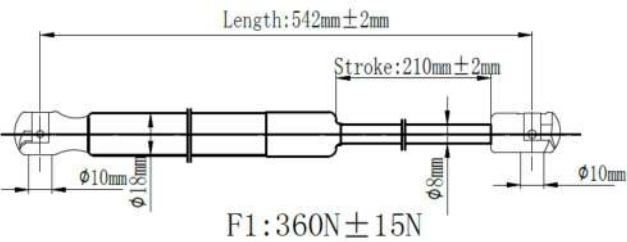

| | | |
|------------|----------|----------|
| Japanparts | Ashika | Japko |
| ZS40044 | ZSA40044 | ZSJ40044 |

O. E. M.: GST151

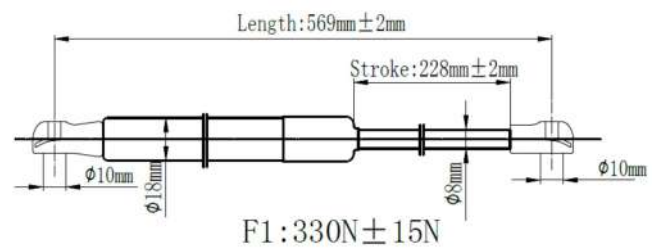

| | | |
|------------|----------|----------|
| Japanparts | Ashika | Japko |
| ZS40045 | ZSA40045 | ZSJ40045 |

O. E. M.: 4808912

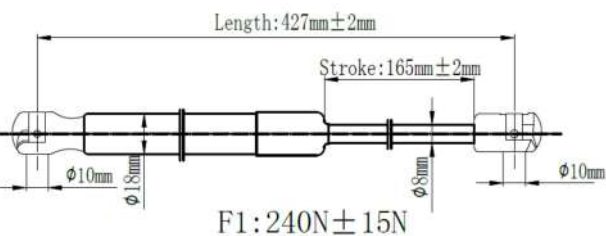

| | | |
|------------|----------|----------|
| Japanparts | Ashika | Japko |
| ZS40046 | ZSA40046 | ZSJ40046 |

O. E. M.: 132081

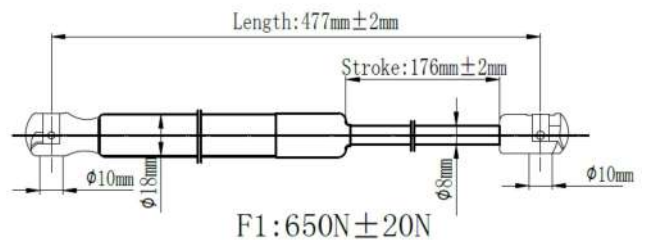

| | | |
|------------|----------|----------|
| Japanparts | Ashika | Japko |
| ZS40047 | ZSA40047 | ZSJ40047 |

O. E. M.: 31217910

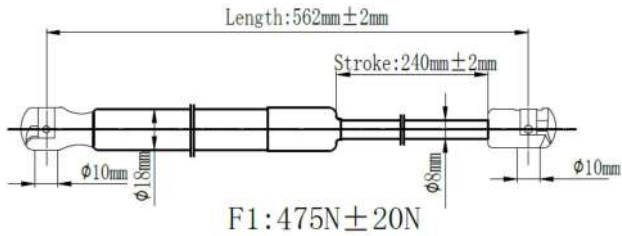

| | | |
|------------|----------|----------|
| Japanparts | Ashika | Japko |
| ZS50000 | ZSA50000 | ZSJ50000 |

O. E. M.: MR138596

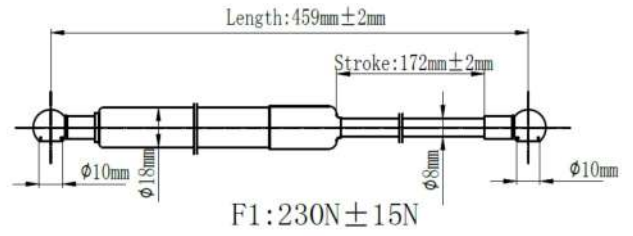

| | | |
|------------|----------|----------|
| Japanparts | Ashika | Japko |
| ZS50001 | ZSA50001 | ZSJ50001 |

O. E. M.: 4291224

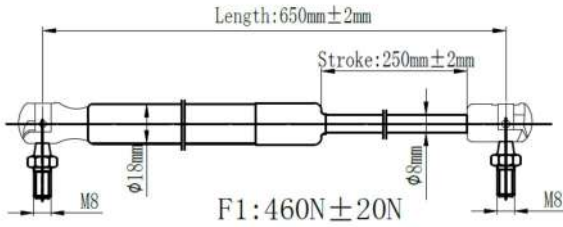

| | | |
|------------|----------|----------|
| Japanparts | Ashika | Japko |
| ZS50002 | ZSA50002 | ZSJ50002 |

O. E. M.: MR248939

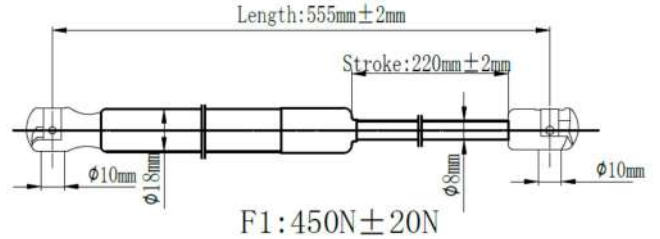

| | | |
|------------|----------|----------|
| Japanparts | Ashika | Japko |
| ZS50003 | ZSA50003 | ZSJ50003 |

O. E. M.: MR101967

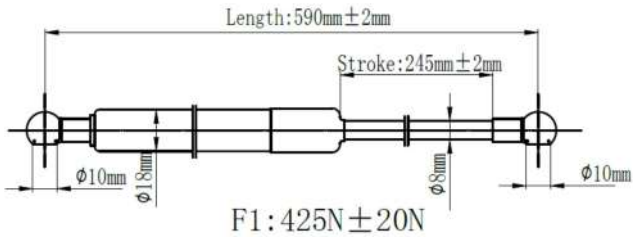

| | | |
|------------|----------|----------|
| Japanparts | Ashika | Japko |
| ZS50004 | ZSA50004 | ZSJ50004 |

O. E. M.: MB927791

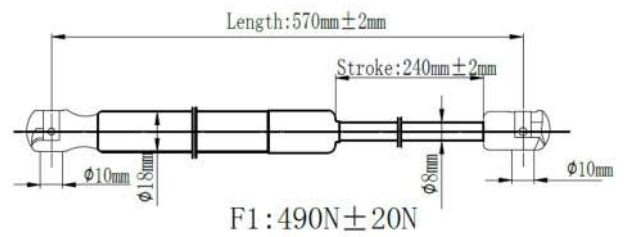

| | | |
|------------|----------|----------|
| Japanparts | Ashika | Japko |
| ZS50005 | ZSA50005 | ZSJ50005 |

O. E. M.: MR991807

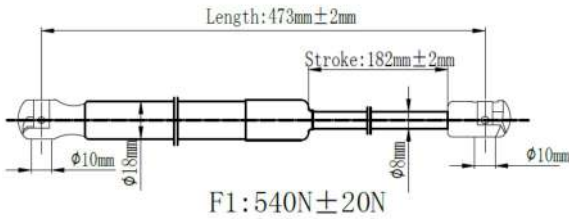

| | | |
|------------|----------|----------|
| Japanparts | Ashika | Japko |
| ZS50006 | ZSA50006 | ZSJ50006 |

O. E. M.: MR959243

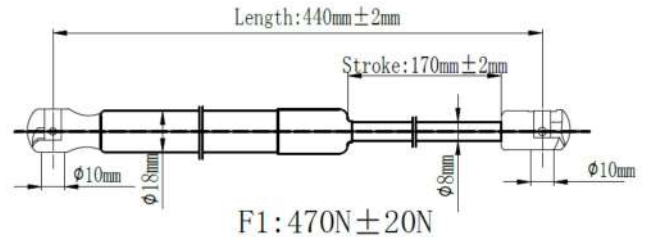

| | | |
|------------|----------|----------|
| Japanparts | Ashika | Japko |
| ZS50007 | ZSA50007 | ZSJ50007 |

O. E. M.: 5802A051

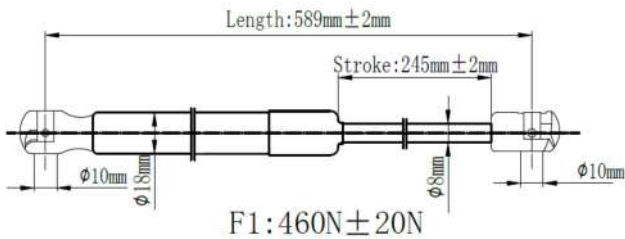

| | | |
|------------|----------|----------|
| Japanparts | Ashika | Japko |
| ZS50008 | ZSA50008 | ZSJ50008 |

O. E. M.: MR599435

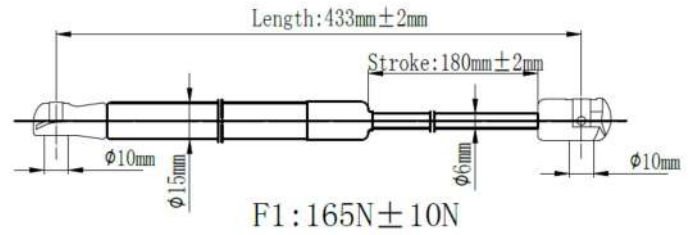

| | | |
|------------|----------|----------|
| Japanparts | Ashika | Japko |
| ZS50009 | ZSA50009 | ZSJ50009 |

O. E. M.: 280149

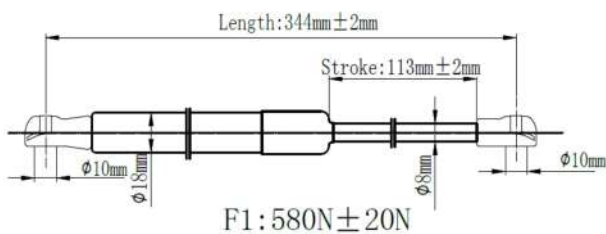

| | | |
|------------|----------|----------|
| Japanparts | Ashika | Japko |
| ZS50010 | ZSA50010 | ZSJ50010 |

O. E. M.: 5802A375

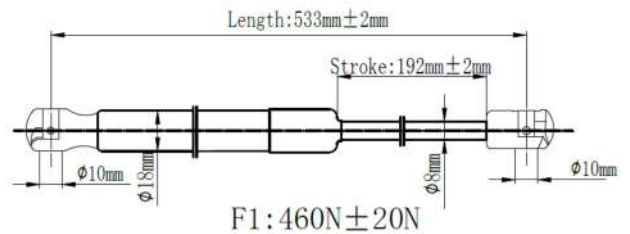

| | | |
|------------|----------|----------|
| Japanparts | Ashika | Japko |
| ZS50011 | ZSA50011 | ZSJ50011 |

O. E. M.: 5925A003

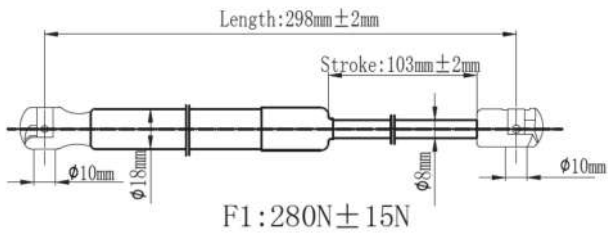

| | | |
|------------|----------|----------|
| Japanparts | Ashika | Japko |
| ZS50012 | ZSA50012 | ZSJ50012 |

O. E. M.: MR415174

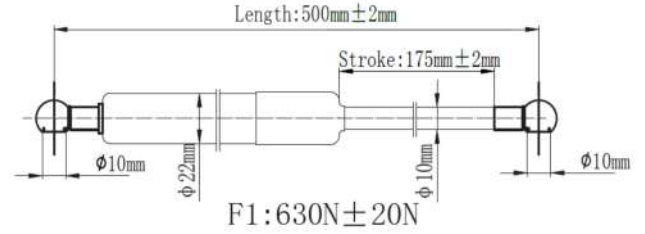

| | | |
|------------|----------|----------|
| Japanparts | Ashika | Japko |
| ZS50013 | ZSA50013 | ZSJ50013 |

O. E. M.: MN159045

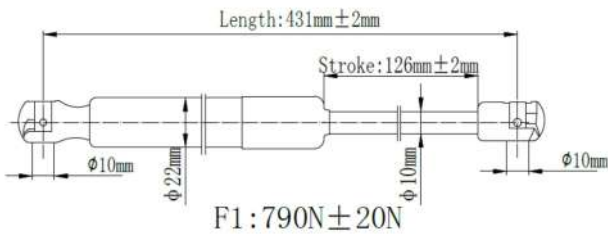

| | | |
|------------|----------|----------|
| Japanparts | Ashika | Japko |
| ZS50014 | ZSA50014 | ZSJ50014 |

O. E. M.: MR271723

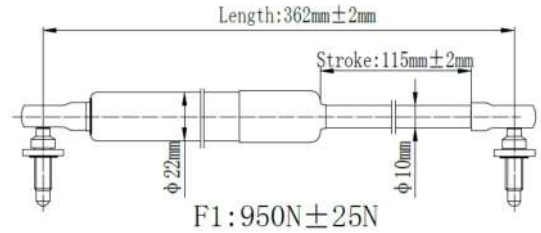

| | | |
|------------|----------|----------|
| Japanparts | Ashika | Japko |
| ZS50015 | ZSA50015 | ZSJ50015 |

O. E. M.: MR375705

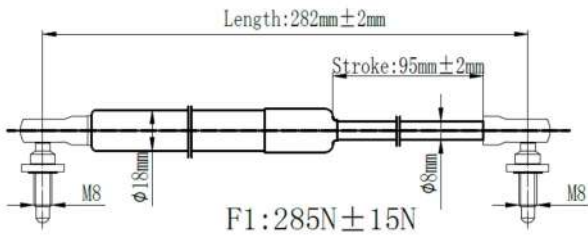

| | | |
|------------|----------|----------|
| Japanparts | Ashika | Japko |
| ZS50016 | ZSA50016 | ZSJ50016 |

O. E. M.: MR415171

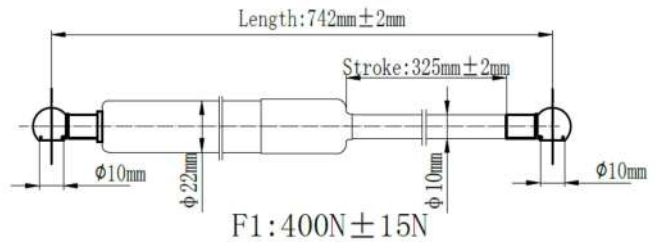

| | | |
|------------|----------|----------|
| Japanparts | Ashika | Japko |
| ZS50017 | ZSA50017 | ZSJ50017 |

O. E. M.: MR970627

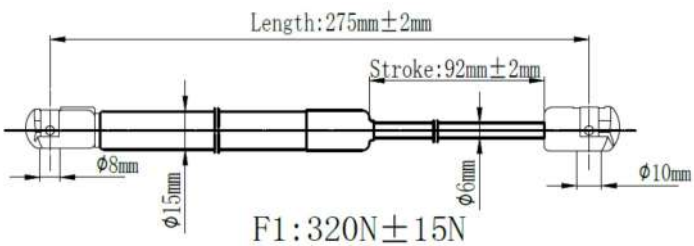

| | | |
|------------|----------|----------|
| Japanparts | Ashika | Japko |
| ZS60000 | ZSA60000 | ZSJ60000 |

O. E. M.: 68950B1031

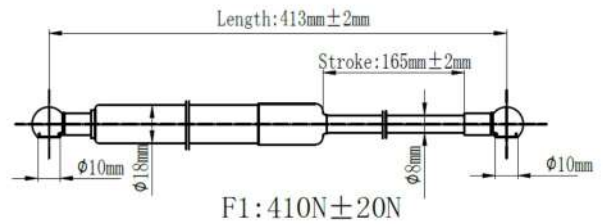

| | | |
|------------|----------|----------|
| Japanparts | Ashika | Japko |
| ZS70000 | ZSA70000 | ZSJ70000 |

O. E. M.: 60335FA000

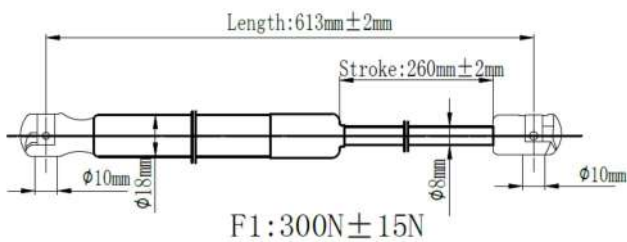

| | | |
|------------|----------|----------|
| Japanparts | Ashika | Japko |
| ZS70001 | ZSA70001 | ZSJ70001 |

O. E. M.: 63269FE000

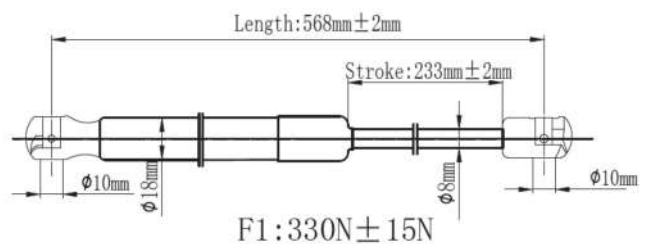

| | | |
|------------|----------|----------|
| Japanparts | Ashika | Japko |
| ZS70002 | ZSA70002 | ZSJ70002 |

O. E. M.: 57259AJ02A

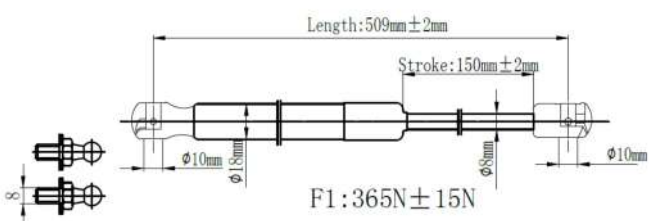

| | | |
|------------|----------|----------|
| Japanparts | Ashika | Japko |
| ZS80000 | ZSA80000 | ZSJ80000 |

O. E. M.: 81860A8010

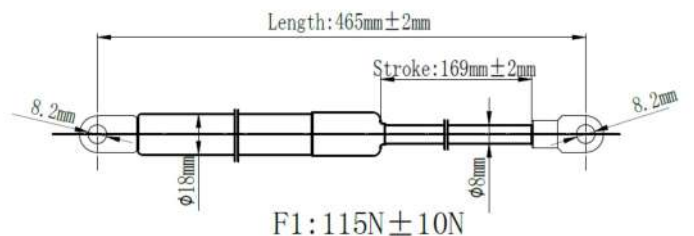

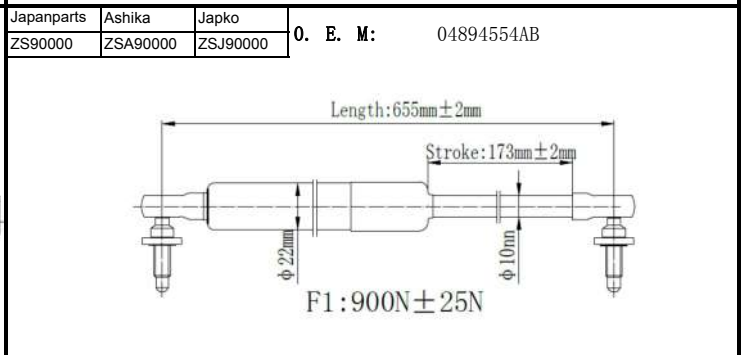
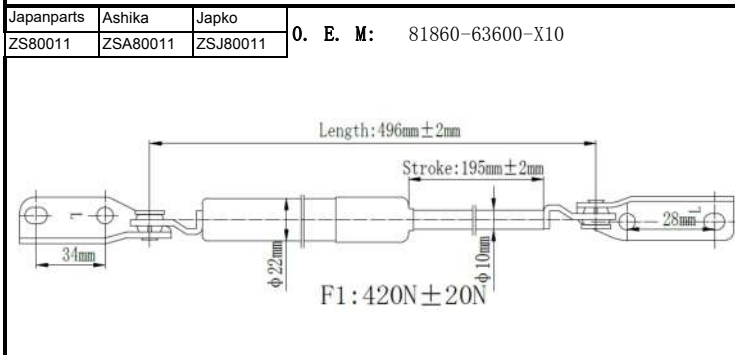
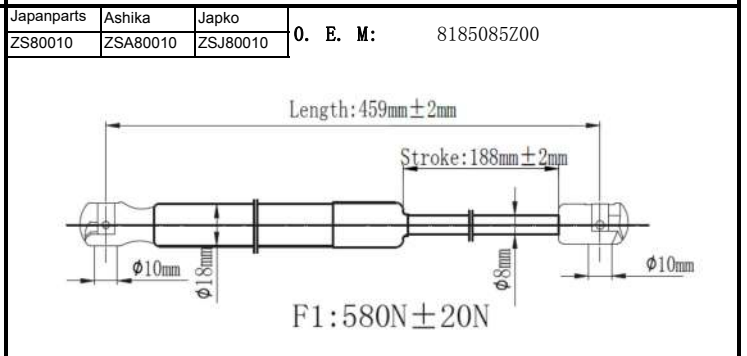
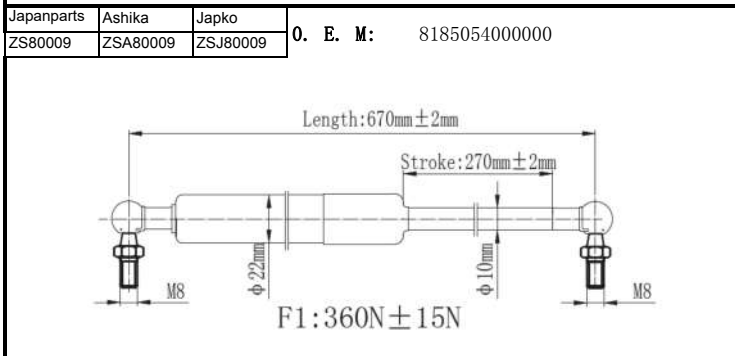
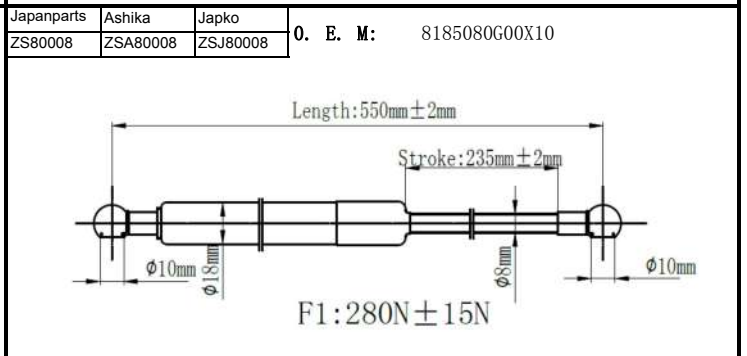
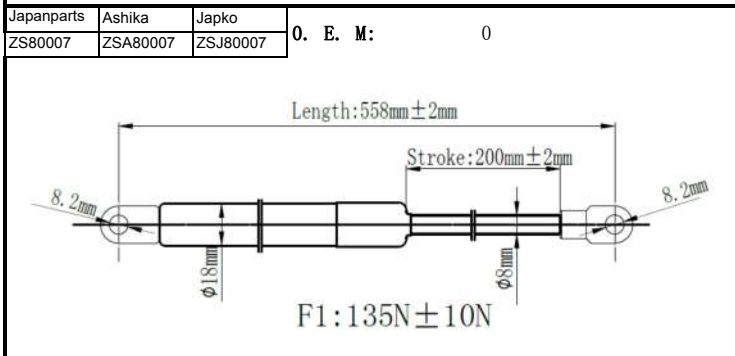
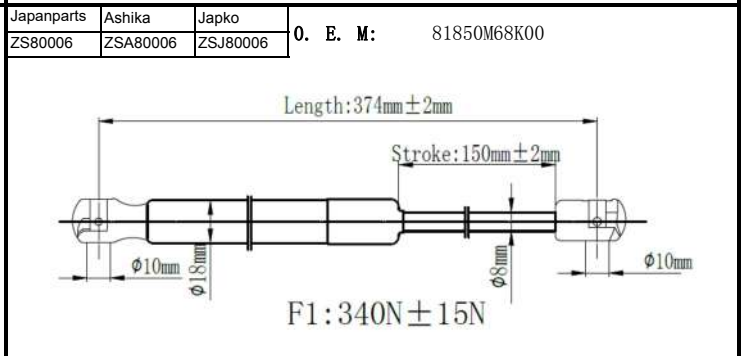
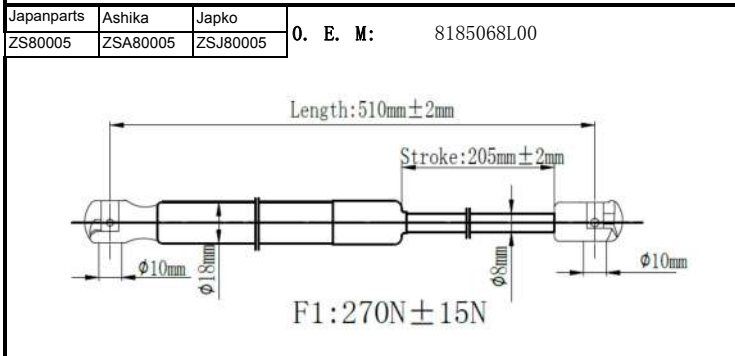
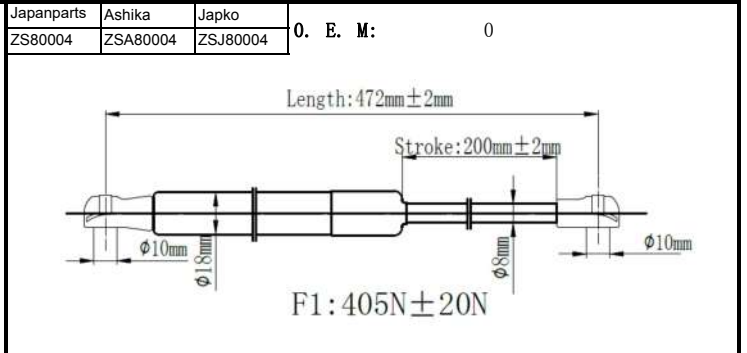
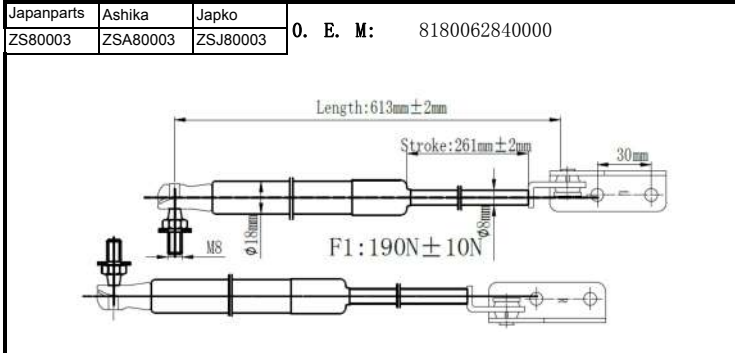
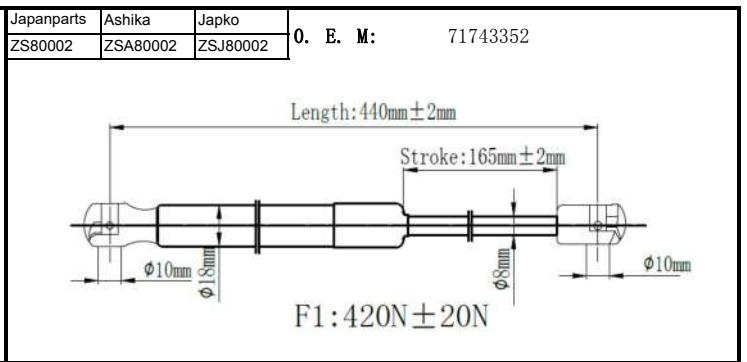
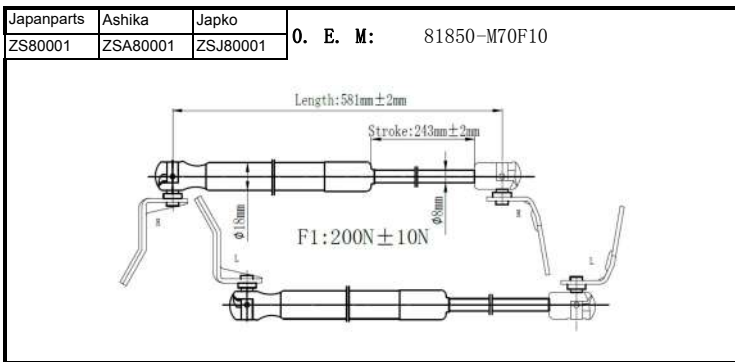

| | | |
|------------|----------|----------|
| Japanparts | Ashika | Japko |
| ZS90001 | ZSA90001 | ZSJ90001 |

O. E. M.: 04589626AA

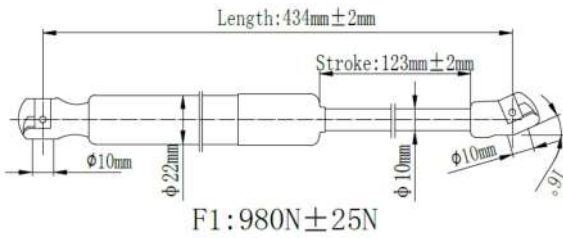

F1: 980N ± 25N

| | | |
|------------|----------|----------|
| Japanparts | Ashika | Japko |
| ZS90002 | ZSA90002 | ZSJ90002 |

O. E. M.: 04589589AA

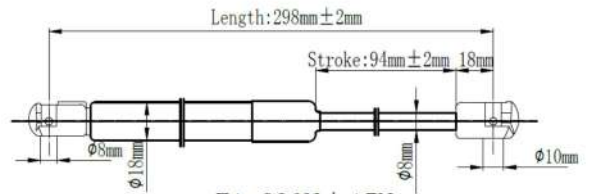

F1: 280N ± 15N

| | | |
|------------|----------|----------|
| Japanparts | Ashika | Japko |
| ZS90003 | ZSA90003 | ZSJ90003 |

O. E. M.: 05109605AC

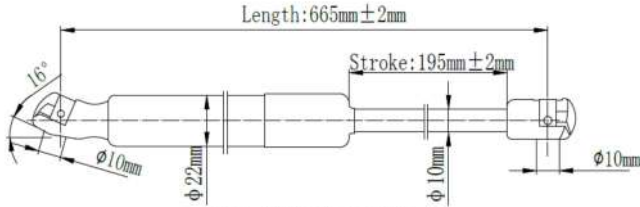

F1: 765N ± 20N

| | | |
|------------|----------|----------|
| Japanparts | Ashika | Japko |
| ZS90004 | ZSA90004 | ZSJ90004 |

O. E. M.: 04724743AD

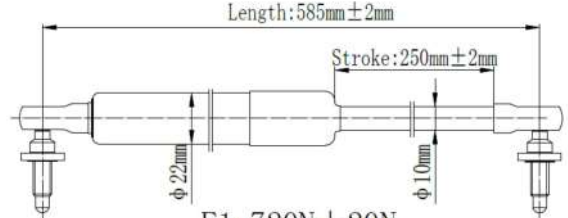

F1: 720N ± 20N

| | | |
|------------|----------|----------|
| Japanparts | Ashika | Japko |
| ZS90005 | ZSA90005 | ZSJ90005 |

O. E. M.: 05054246AB

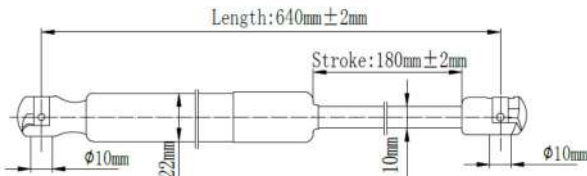

F1: 775N ± 20N

| | | |
|------------|----------|----------|
| Japanparts | Ashika | Japko |
| ZS90006 | ZSA90006 | ZSJ90006 |

O. E. M.: 4575806AC

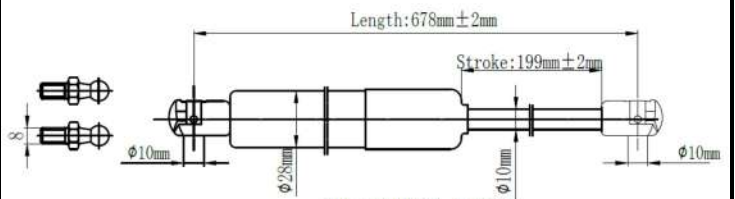

F1: 1035N ± 25N

| | | |
|------------|----------|----------|
| Japanparts | Ashika | Japko |
| ZS90007 | ZSA90007 | ZSJ90007 |

O. E. M.: 4865310AA

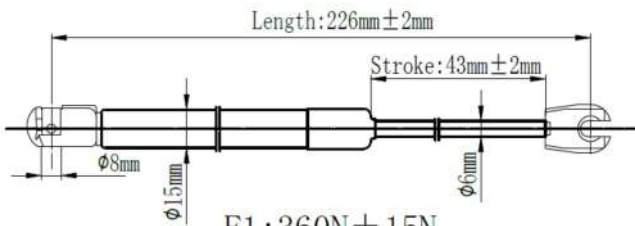

F1: 360N ± 15N

| | | |
|------------|----------|----------|
| Japanparts | Ashika | Japko |
| ZS90008 | ZSA90008 | ZSJ90008 |

O. E. M.: 4878430AA

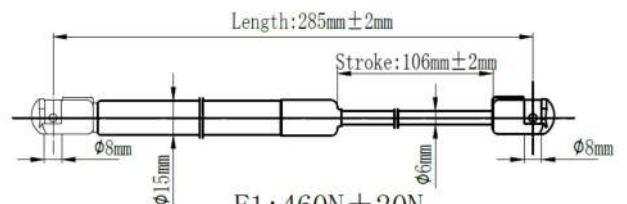

F1: 460N ± 20N

| | | |
|------------|----------|----------|
| Japanparts | Ashika | Japko |
| ZS90009 | ZSA90009 | ZSJ90009 |

O. E. M.: 5067236AB

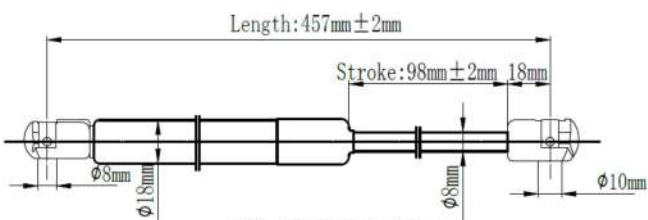

F1: 300N ± 15N

| | | |
|------------|----------|----------|
| Japanparts | Ashika | Japko |
| ZS90010 | ZSA90010 | ZSJ90010 |

O. E. M.: 5074535AB

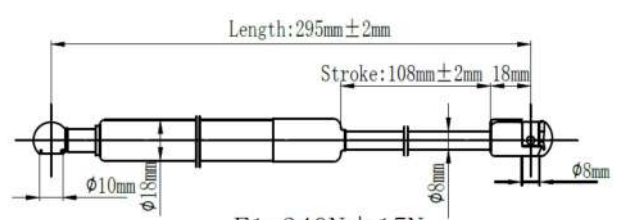

F1: 340N ± 15N

| | | |
|------------|----------|----------|
| Japanparts | Ashika | Japko |
| ZS90011 | ZSA90011 | ZSJ90011 |

O. E. M.: 5140762AA

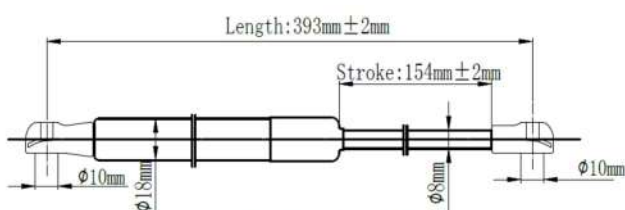

F1: 355N ± 15N

| | | |
|------------|----------|----------|
| Japanparts | Ashika | Japko |
| ZS90012 | ZSA90012 | ZSJ90012 |

O. E. M.: 04589654AB

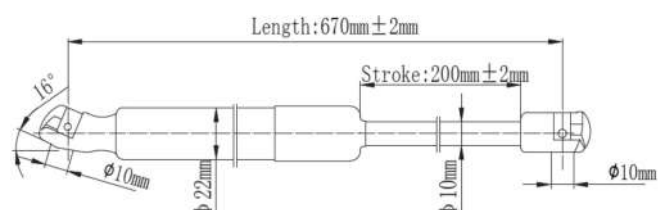

F1: 725N ± 20N

| | | |
|------------|----------|----------|
| Japanparts | Ashika | Japko |
| ZS90013 | ZSA90013 | ZSJ90013 |

O. E. M.: 55113776AA

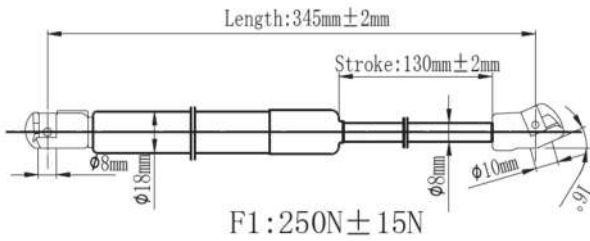

| | | |
|------------|----------|----------|
| Japanparts | Ashika | Japko |
| ZS90014 | ZSA90014 | ZSJ90014 |

O. E. M.: 4814200AF

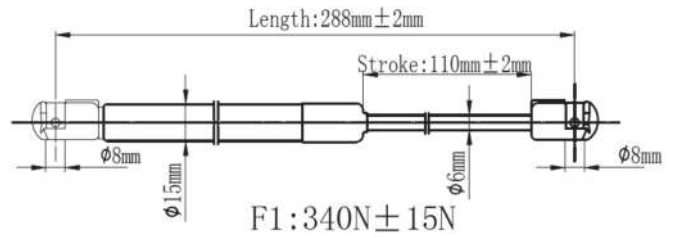

| | | |
|------------|----------|----------|
| Japanparts | Ashika | Japko |
| ZS90015 | ZSA90015 | ZSJ90015 |

O. E. M.: 5056203AD

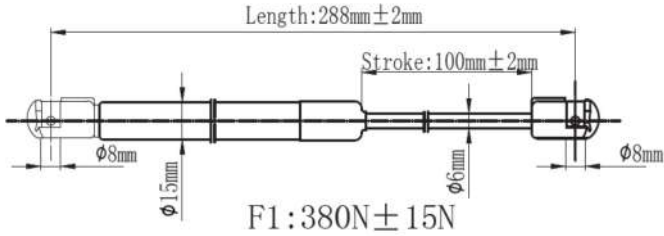

| | | |
|------------|----------|----------|
| Japanparts | Ashika | Japko |
| ZS90016 | ZSA90016 | ZSJ90016 |

O. E. M.: 55362108AA

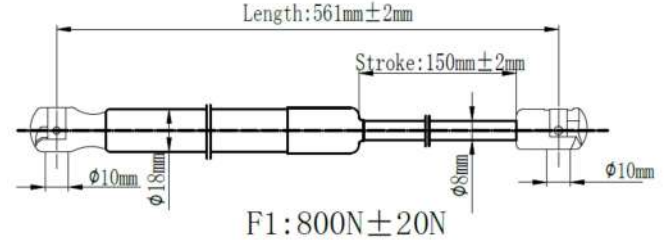

| | | |
|------------|----------|----------|
| Japanparts | Ashika | Japko |
| ZS90017 | ZSA90017 | ZSJ90017 |

O. E. M.: 05101653AA

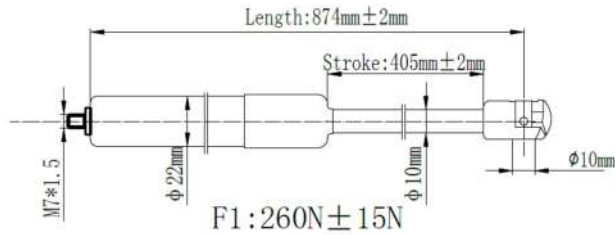

| | | |
|------------|----------|----------|
| Japanparts | Ashika | Japko |
| ZS90018 | ZSA90018 | ZSJ90018 |

O. E. M.:

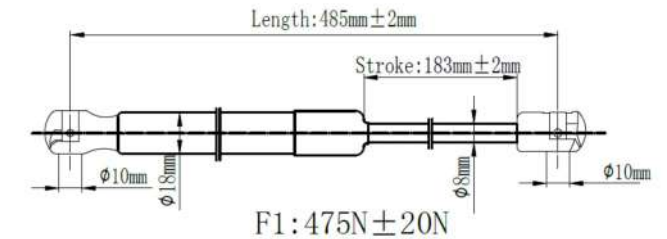

| | | |
|------------|----------|----------|
| Japanparts | Ashika | Japko |
| ZS90019 | ZSA90019 | ZSJ90019 |

O. E. M.: 55360915AB

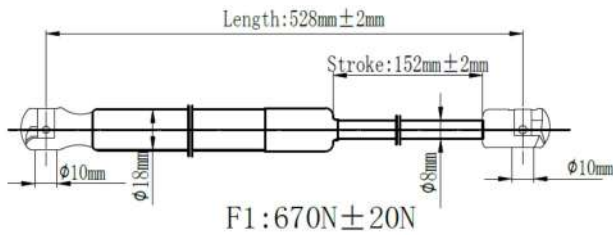

| | | |
|------------|----------|----------|
| Japanparts | Ashika | Japko |
| ZS90020 | ZSA90020 | ZSJ90020 |

O. E. M.: 55276321AB

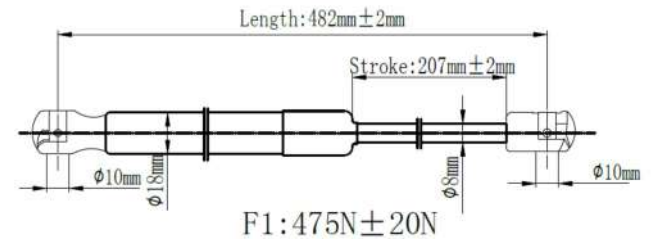

| | | |
|------------|----------|----------|
| Japanparts | Ashika | Japko |
| ZS90021 | ZSA90021 | ZSJ90021 |

O. E. M.: K04589606AB

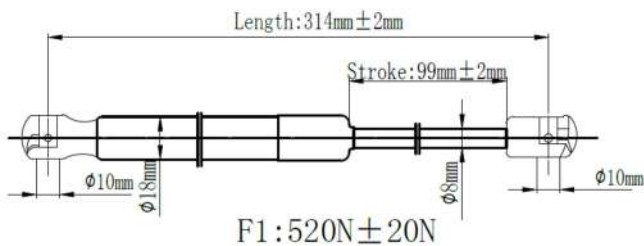

| | | |
|------------|----------|----------|
| Japanparts | Ashika | Japko |
| ZS90022 | ZSA90022 | ZSJ90022 |

O. E. M.: 05178293AC

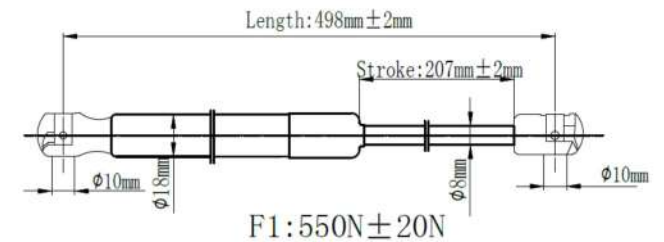

| | | |
|------------|----------|----------|
| Japanparts | Ashika | Japko |
| ZS90023 | ZSA90023 | ZSJ90023 |

O. E. M.: 05155055AB

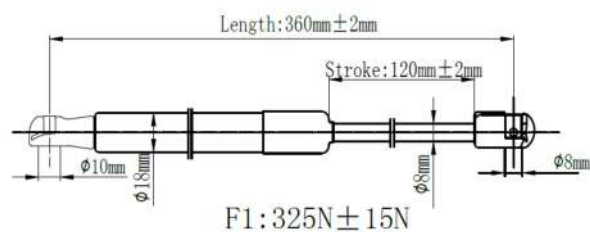

| | | |
|------------|----------|----------|
| Japanparts | Ashika | Japko |
| ZS90024 | ZSA90024 | ZSJ90024 |

O. E. M.: 4865820AD

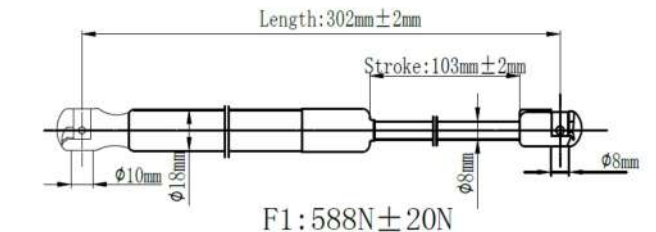

| | | |
|------------|----------|----------|
| Japanparts | Ashika | Japko |
| ZS90025 | ZSA90025 | ZSJ90025 |

O. E. M.: 5074168AC

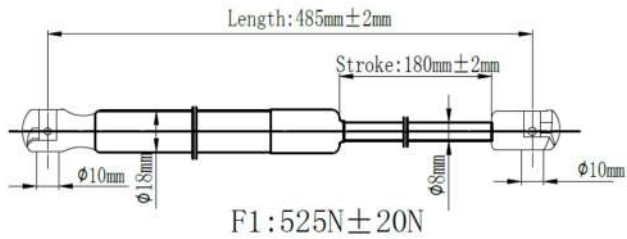

| | | |
|------------|----------|----------|
| Japanparts | Ashika | Japko |
| ZS90026 | ZSA90026 | ZSJ90026 |

O. E. M.: 68035556AA

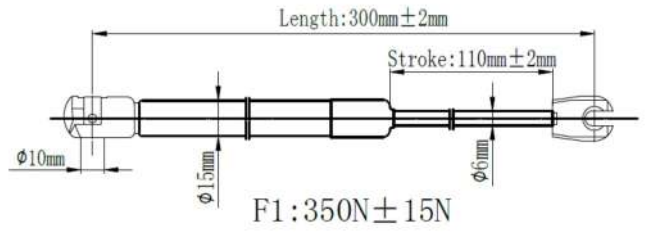

| | | |
|------------|----------|----------|
| Japanparts | Ashika | Japko |
| ZS90027 | ZSA90027 | ZSJ90027 |

O. E. M.: 55359726AC

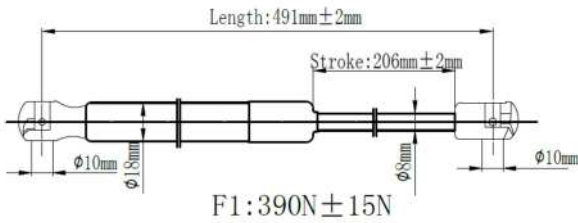

| | | |
|------------|----------|----------|
| Japanparts | Ashika | Japko |
| ZS90028 | ZSA90028 | ZSJ90028 |

O. E. M.: 55136764AA

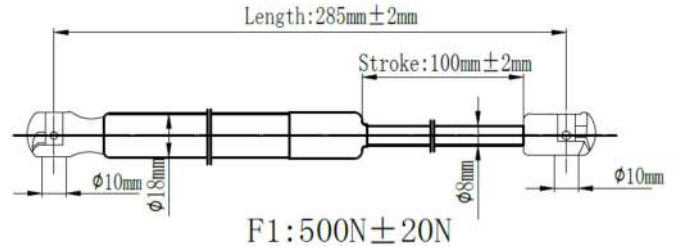

| | | |
|------------|----------|----------|
| Japanparts | Ashika | Japko |
| ZS90029 | ZSA90029 | ZSJ90029 |

O. E. M.: 55137022AA

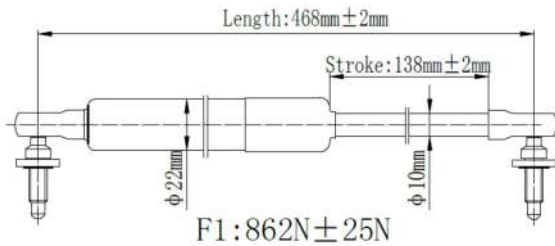

| | | |
|------------|----------|----------|
| Japanparts | Ashika | Japko |
| ZS90030 | ZSA90030 | ZSJ90030 |

O. E. M.: 55113748AA

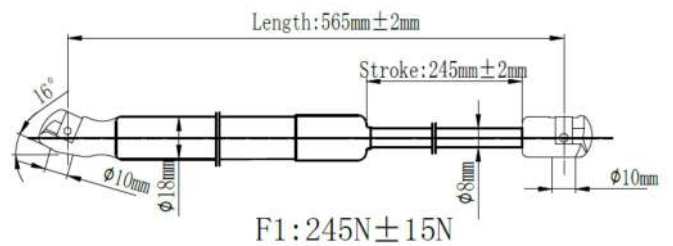

| | | |
|------------|----------|----------|
| Japanparts | Ashika | Japko |
| ZS90031 | ZSA90031 | ZSJ90031 |

O. E. M.: 55074783

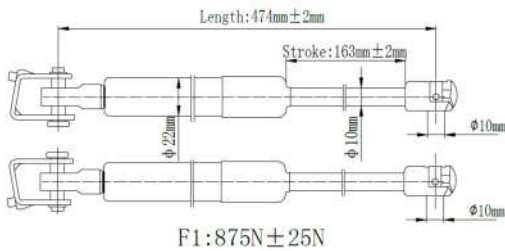

| | | |
|------------|----------|----------|
| Japanparts | Ashika | Japko |
| ZS90032 | ZSA90032 | ZSJ90032 |

O. E. M.: 55360171AA

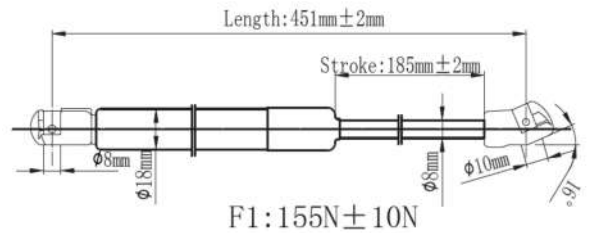

| | | |
|------------|----------|----------|
| Japanparts | Ashika | Japko |
| ZS90033 | ZSA90033 | ZSJ90033 |

O. E. M.: 55394472AA

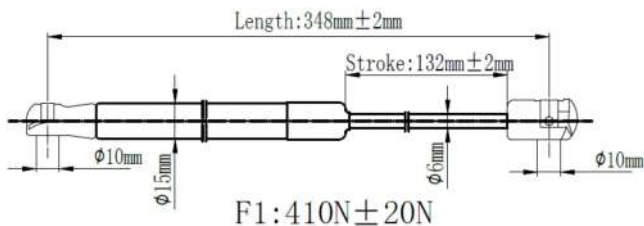

| | | |
|------------|----------|----------|
| Japanparts | Ashika | Japko |
| ZS90034 | ZSA90034 | ZSJ90034 |

O. E. M.: 55027180

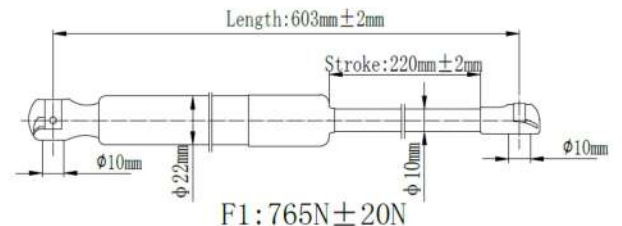

| | | |
|------------|----------|----------|
| Japanparts | Ashika | Japko |
| ZS90035 | ZSA90035 | ZSJ90035 |

O. E. M.: 4522RF

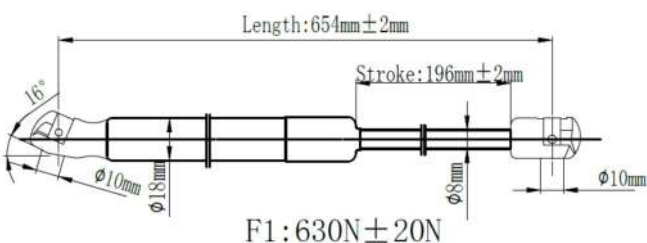

| | | |
|------------|----------|----------|
| Japanparts | Ashika | Japko |
| ZS90036 | ZSA90036 | ZSJ90036 |

O. E. M.: 55136761

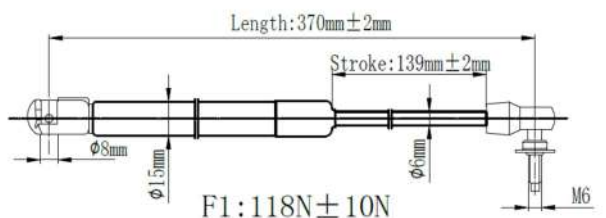

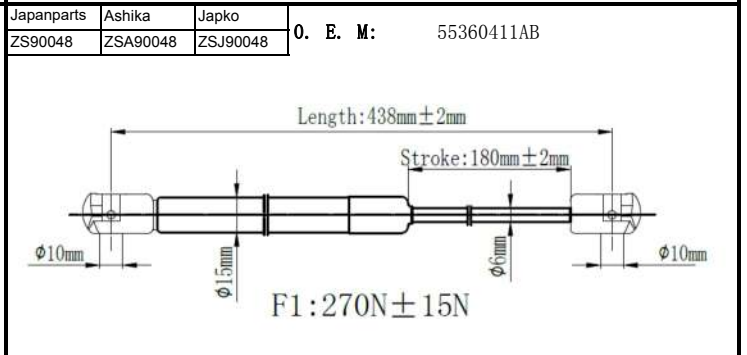
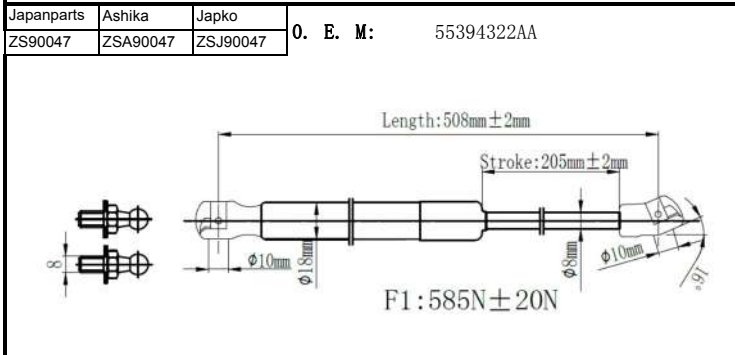
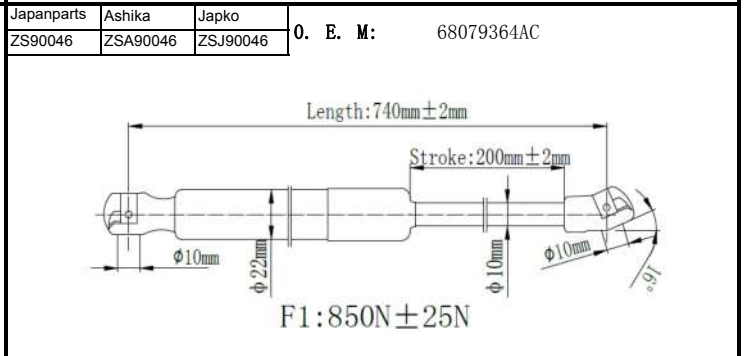
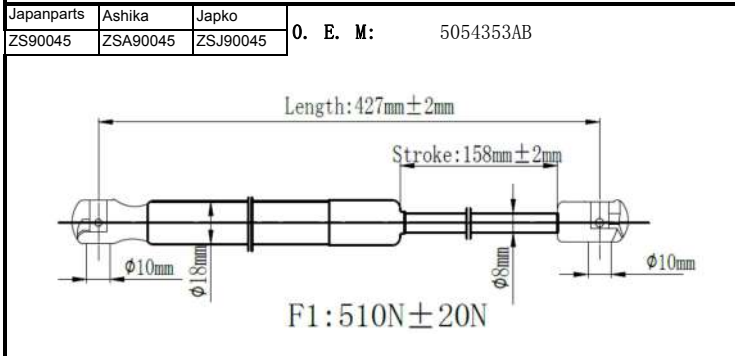
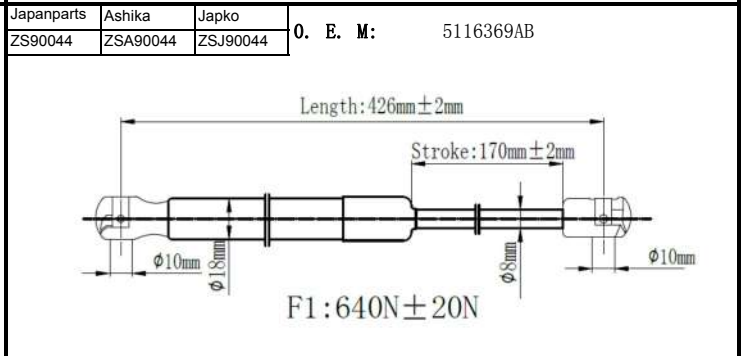
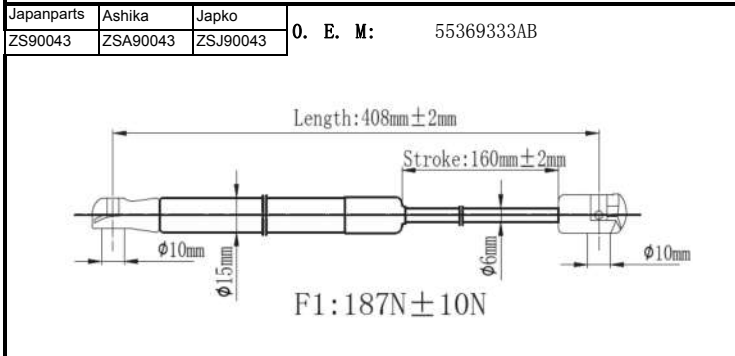
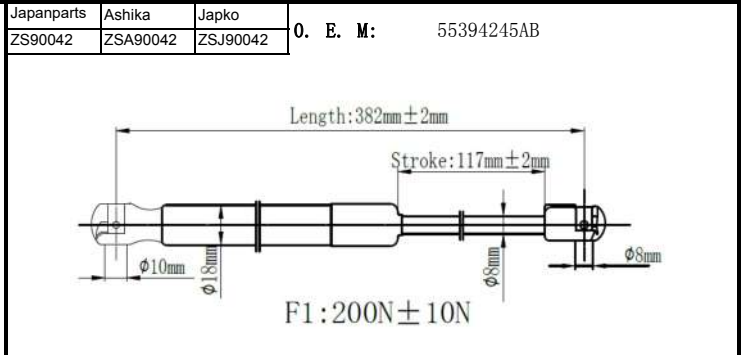
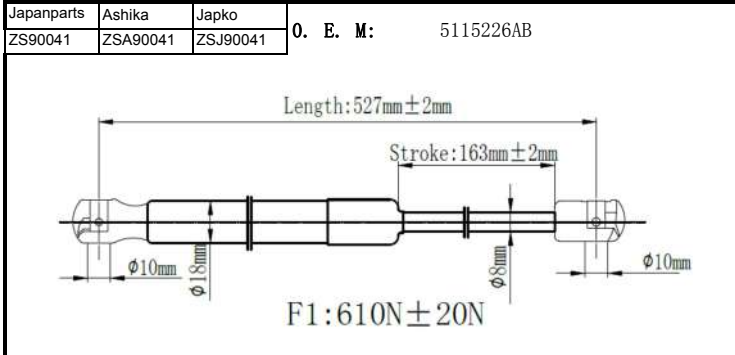
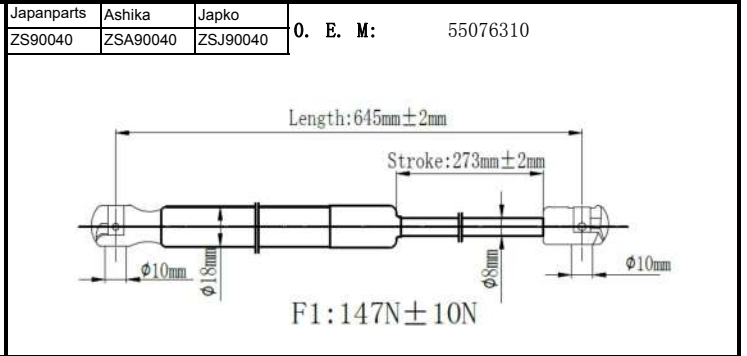
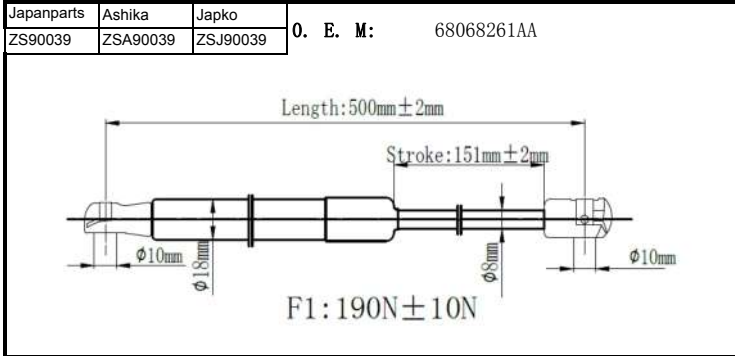
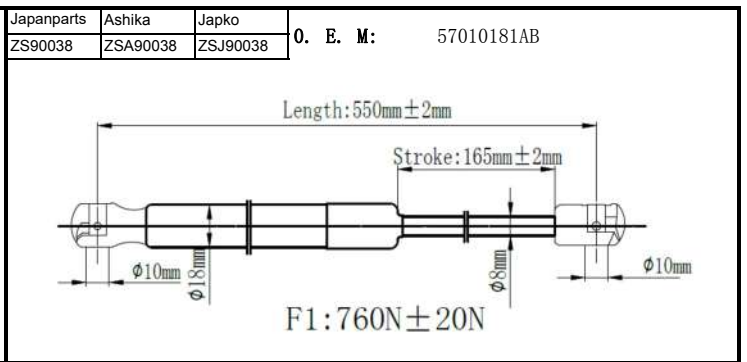
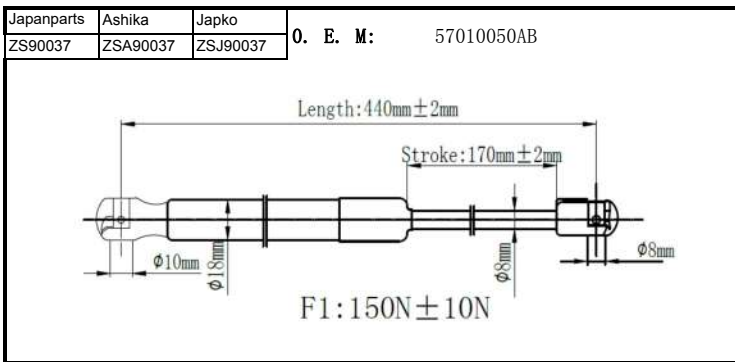

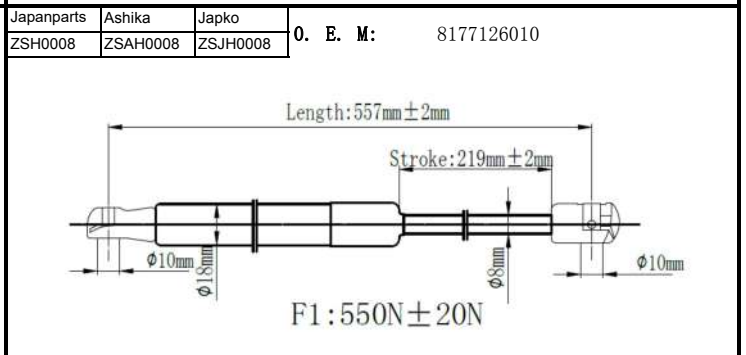
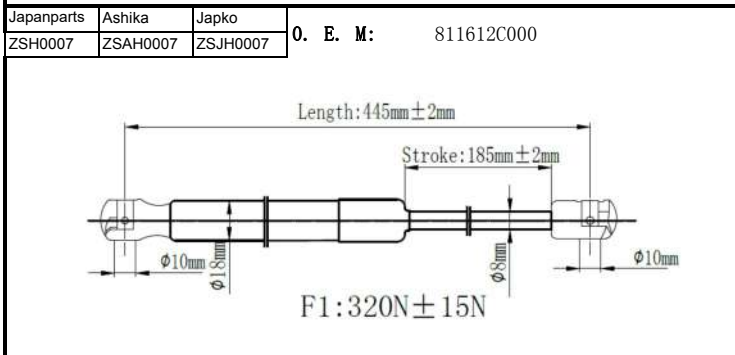
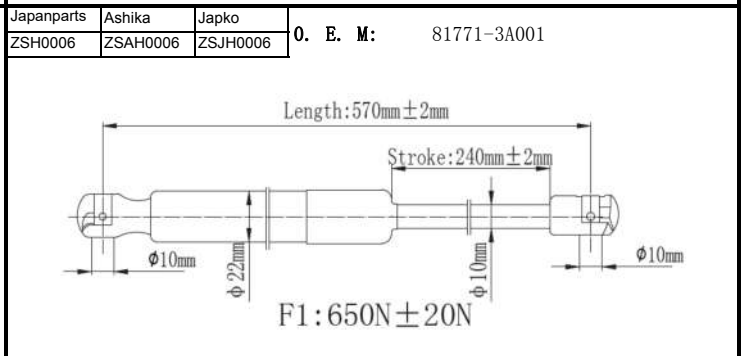
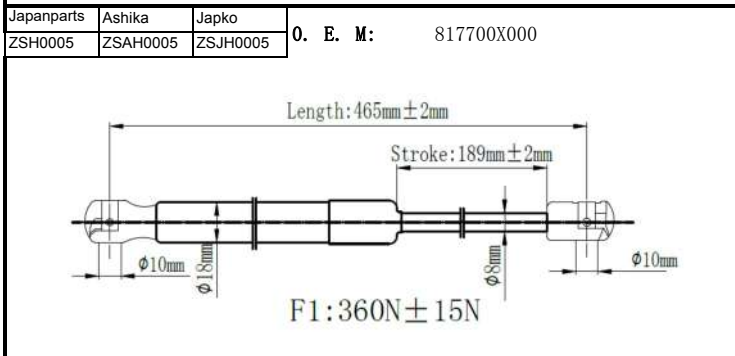
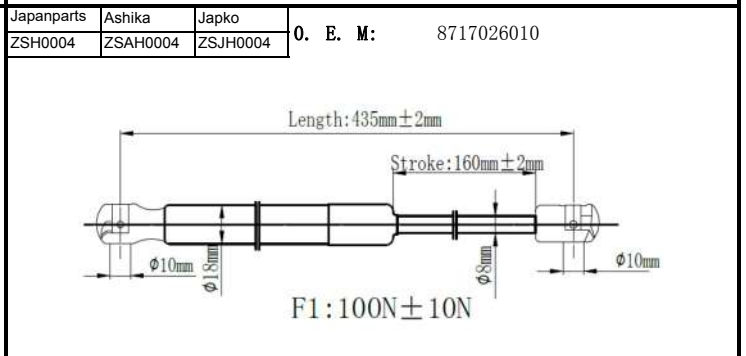
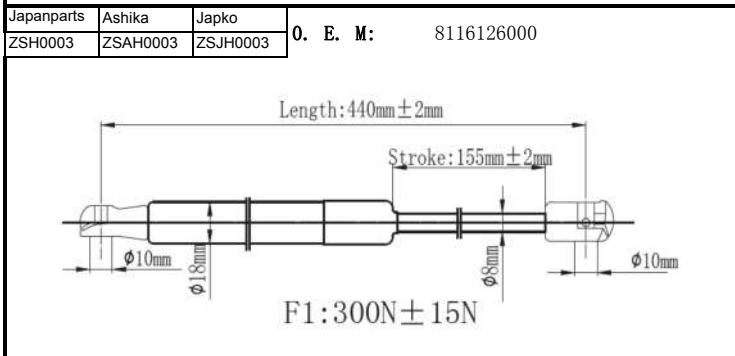
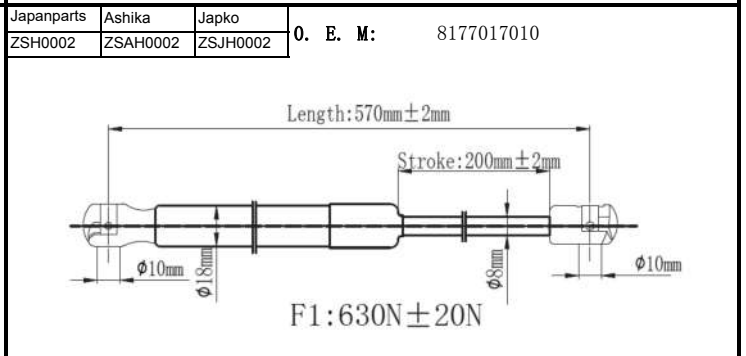
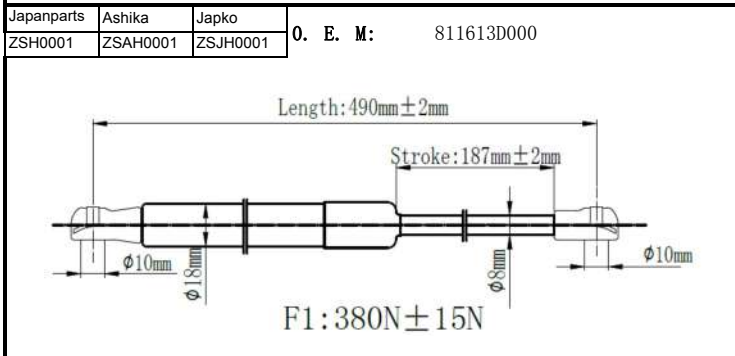
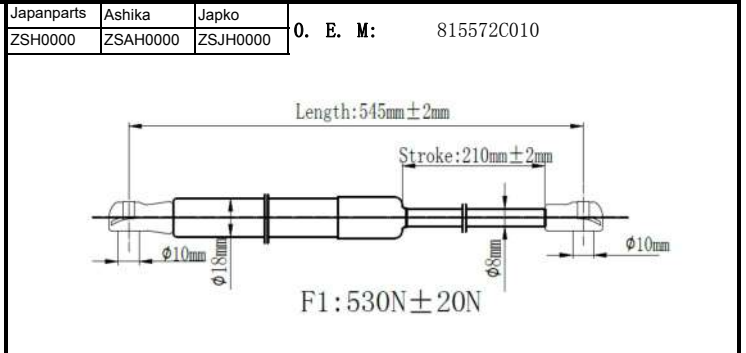
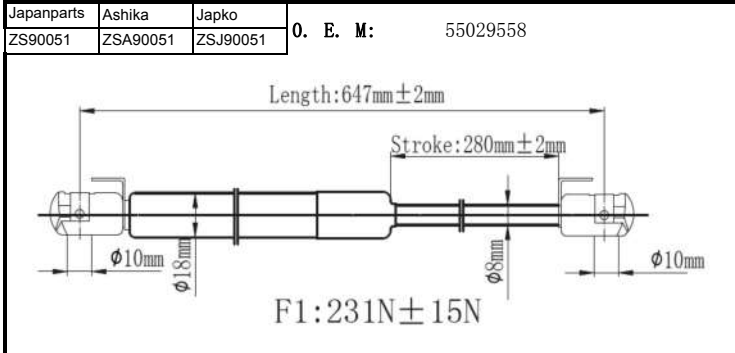
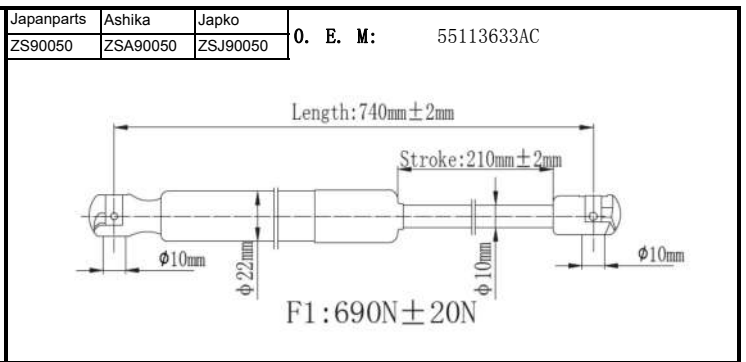
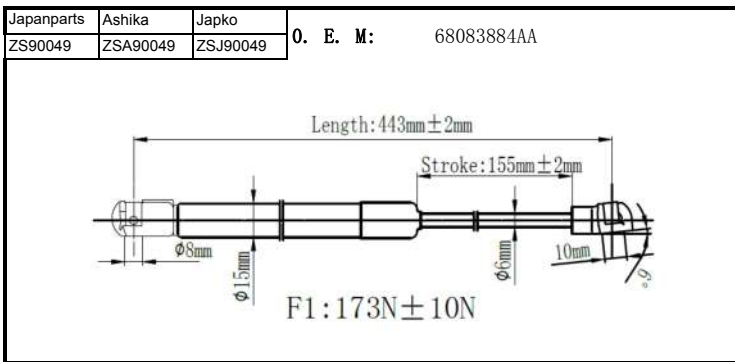

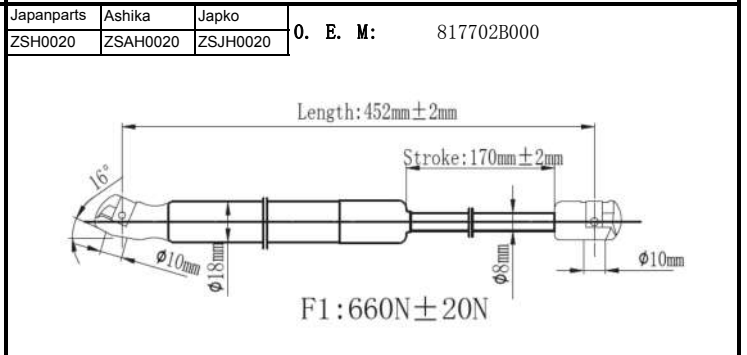
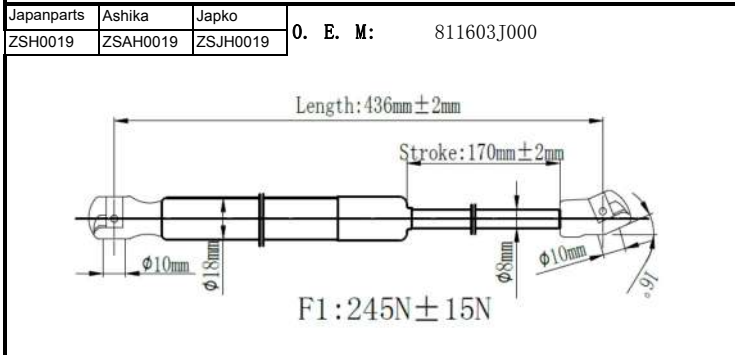
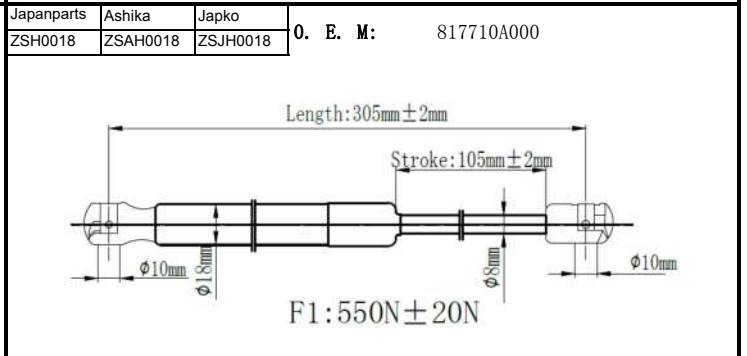
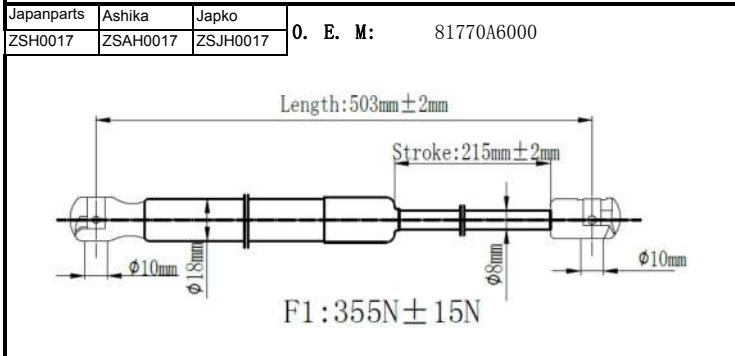
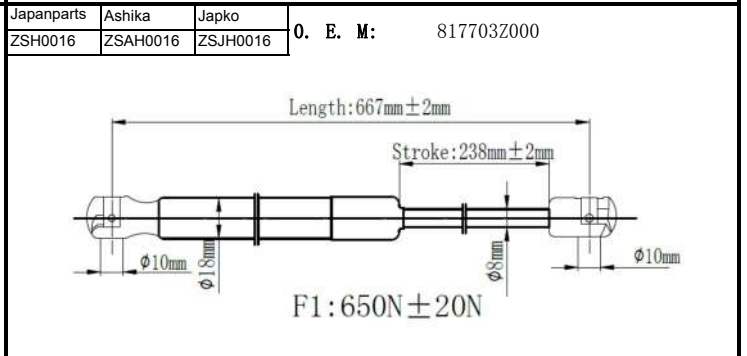
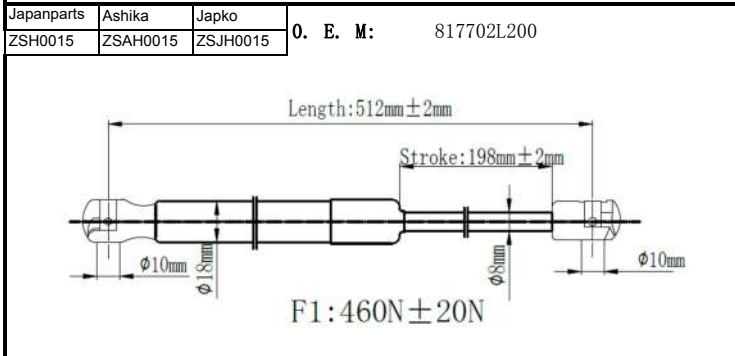
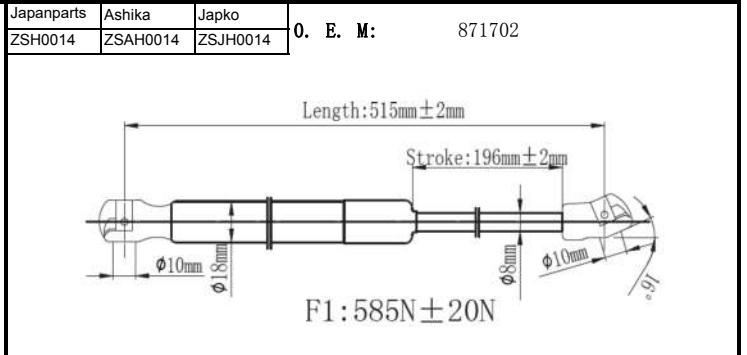
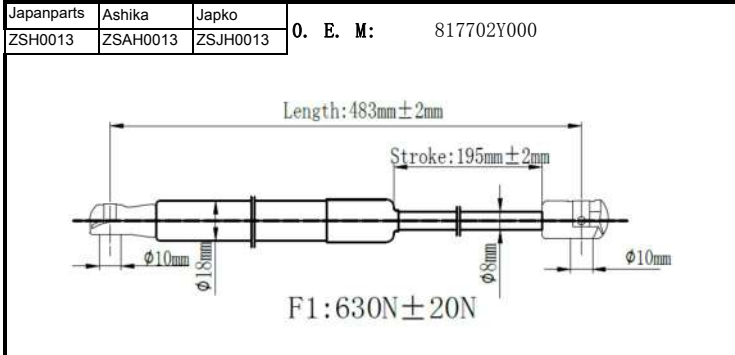
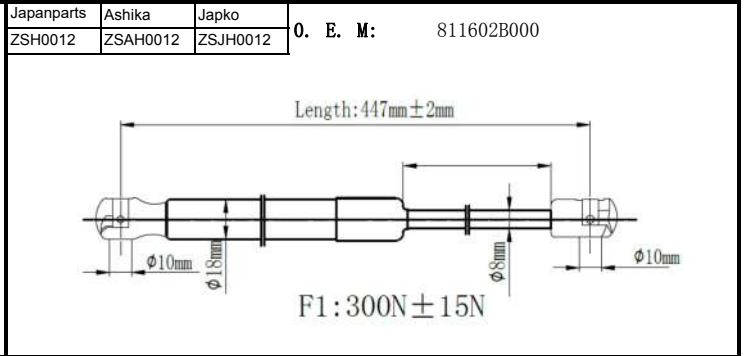
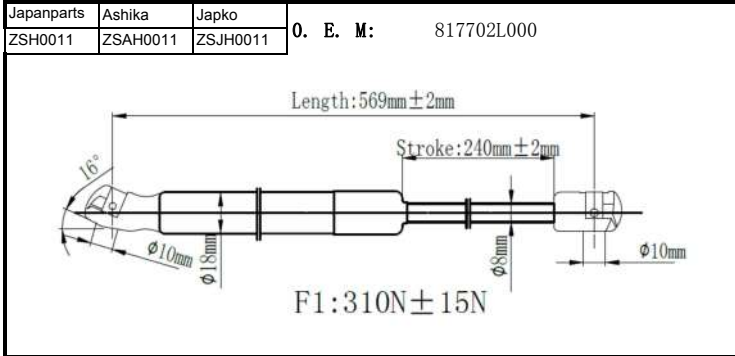
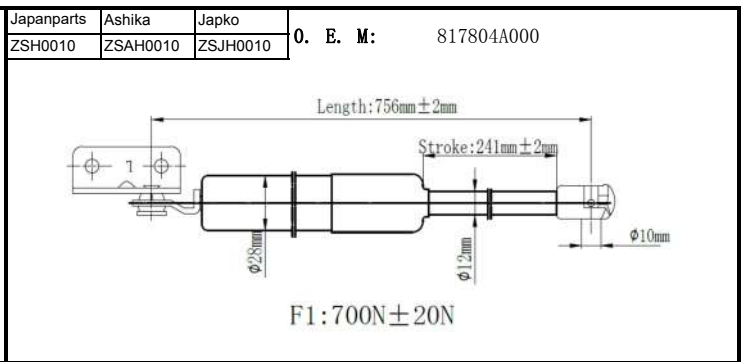
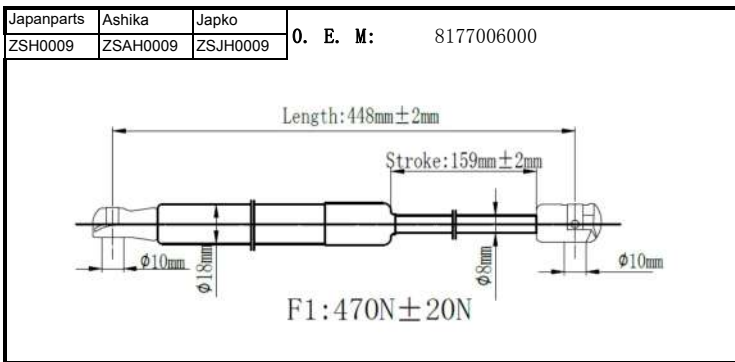

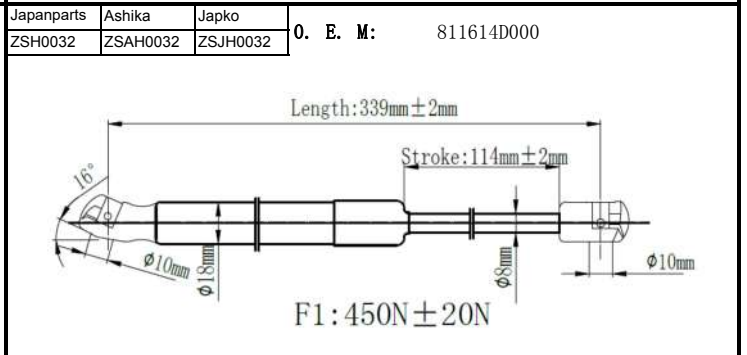
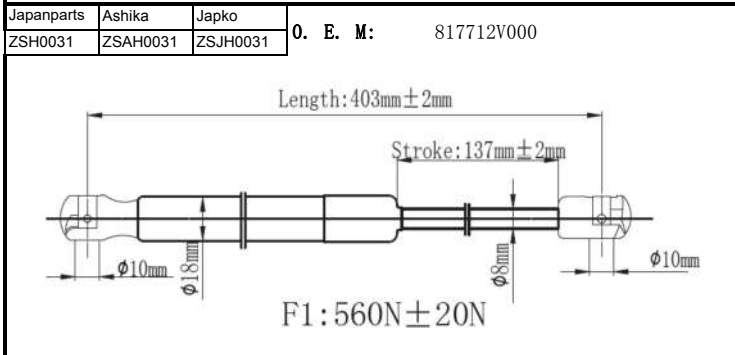
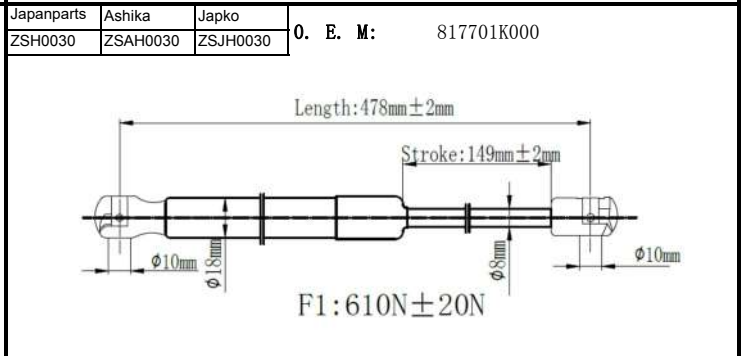
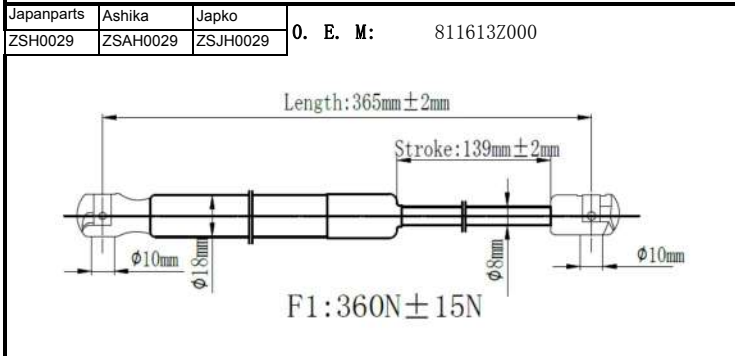
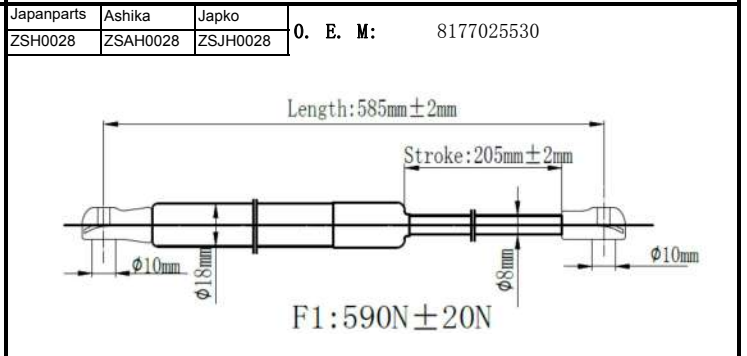
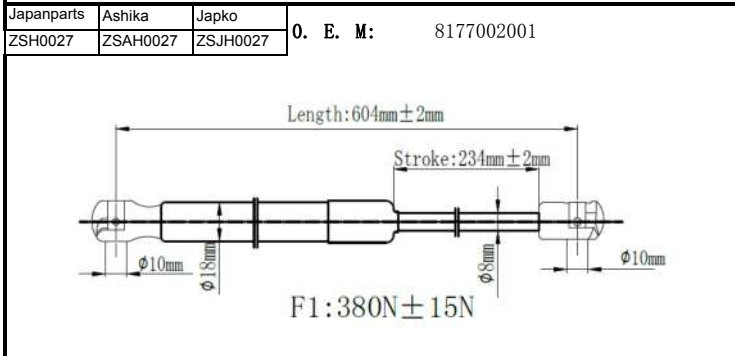
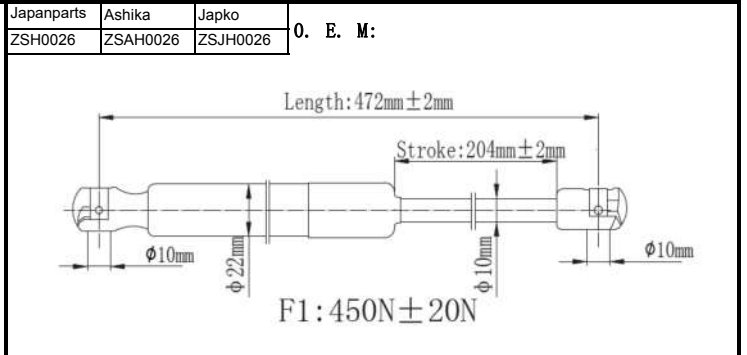
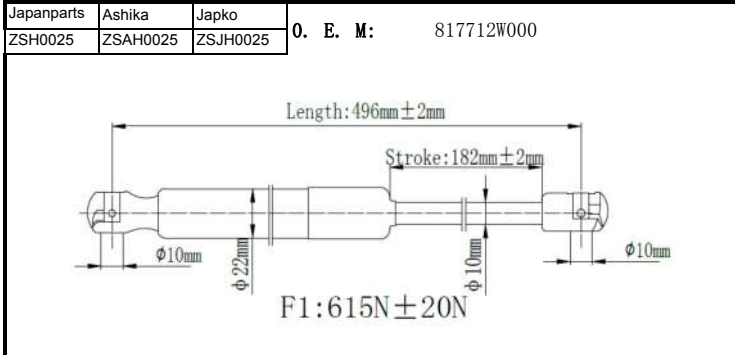
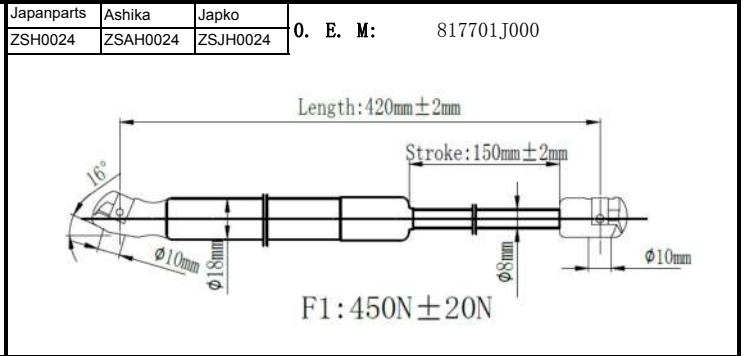
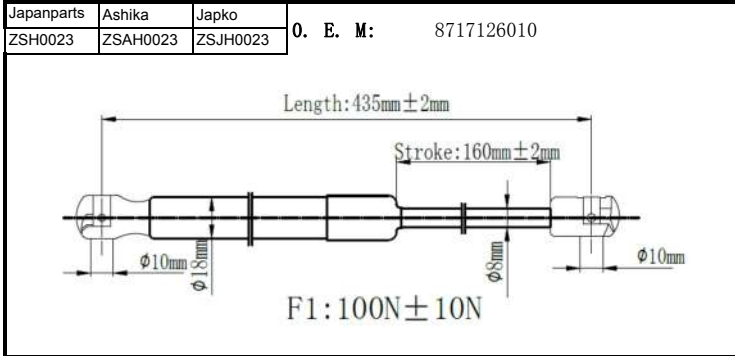
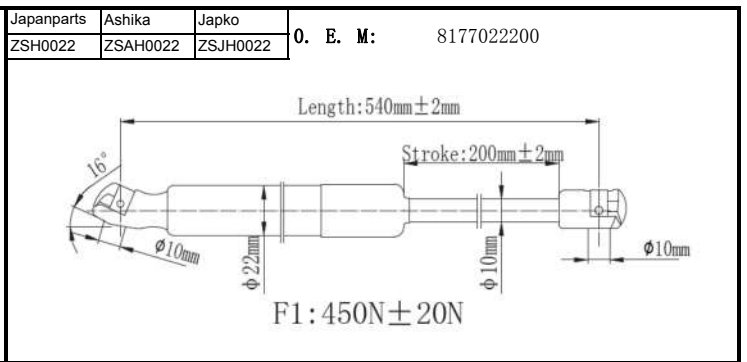
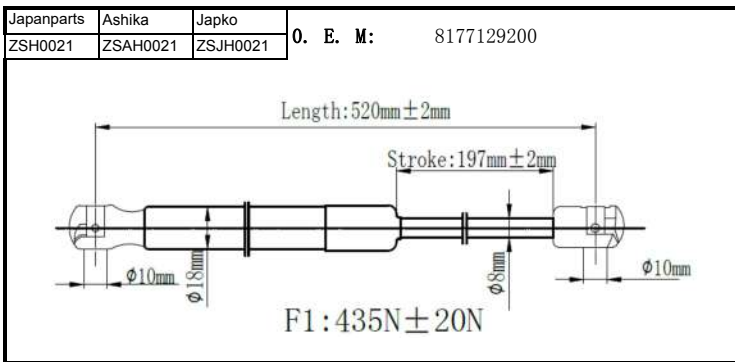

| | | |
|------------|----------|----------|
| Japanparts | Ashika | Japko |
| ZSH0033 | ZSAH0033 | ZSJH0033 |

O. E. M: 852059

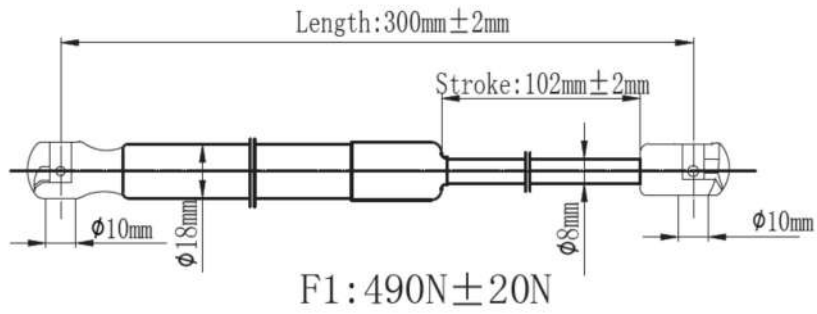

| | | |
|------------|----------|----------|
| Japanparts | Ashika | Japko |
| ZSH0037 | ZSAH0037 | ZSJH0037 |

O. E. M: 817904A010

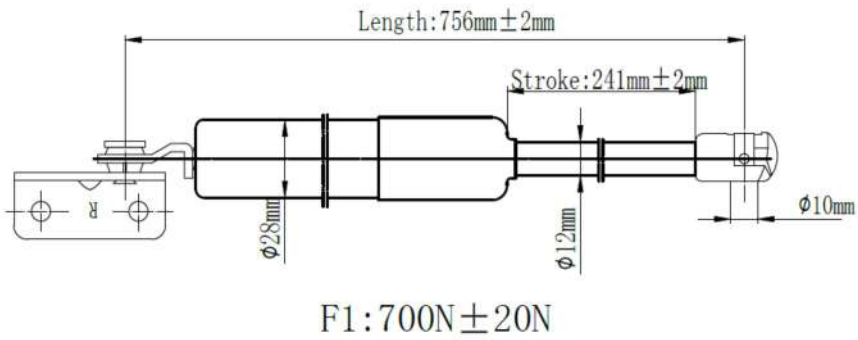

| | | |
|------------|----------|----------|
| Japanparts | Ashika | Japko |
| ZSH0038 | ZSAH0038 | ZSJH0038 |

O. E. M: 81770B9000

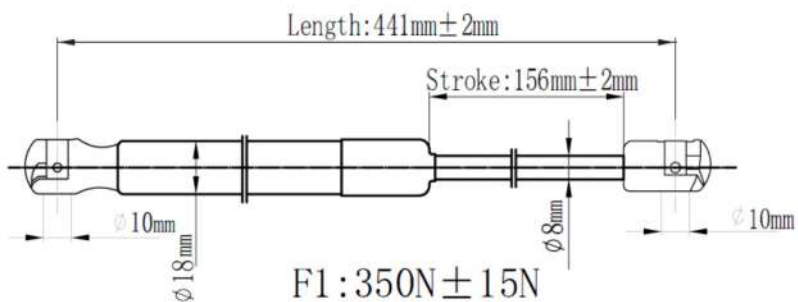

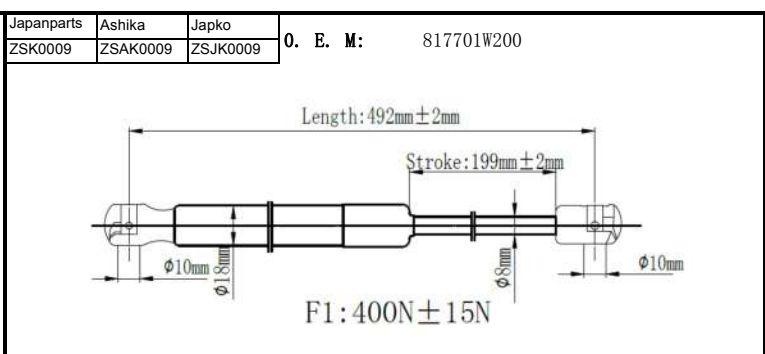
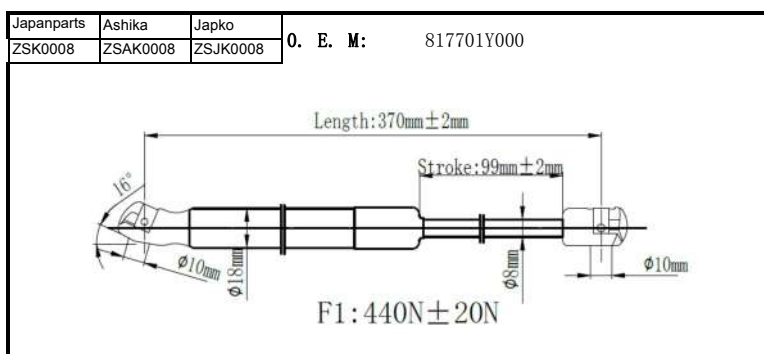
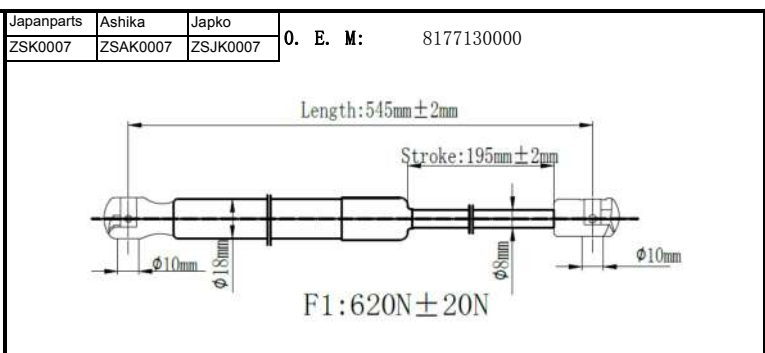
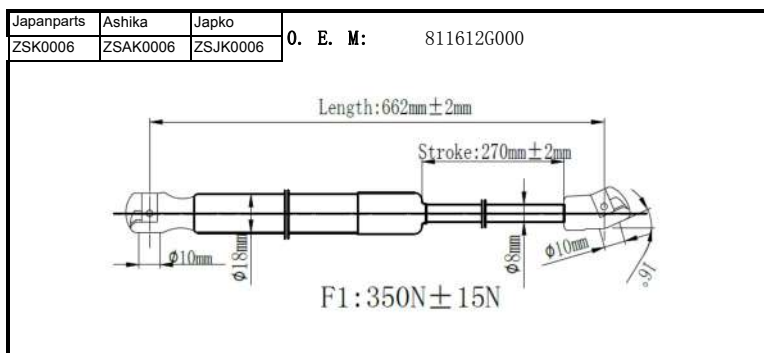
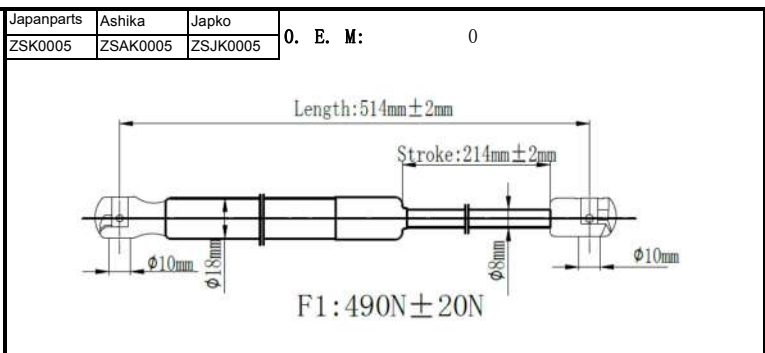
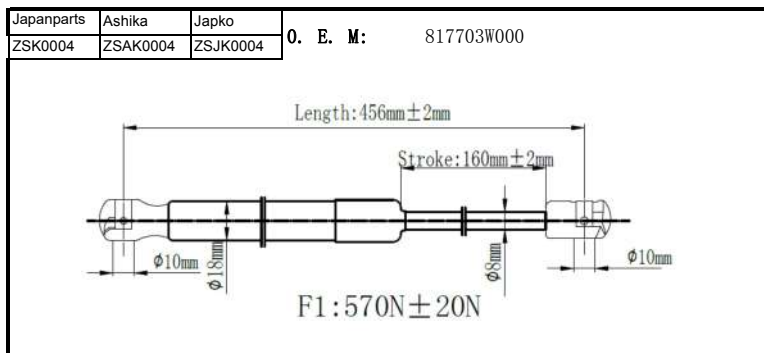
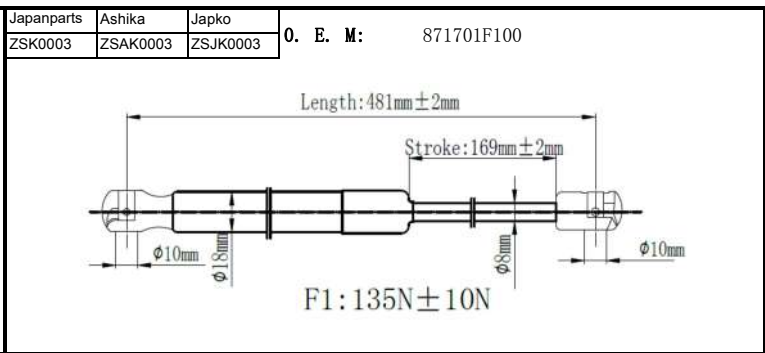
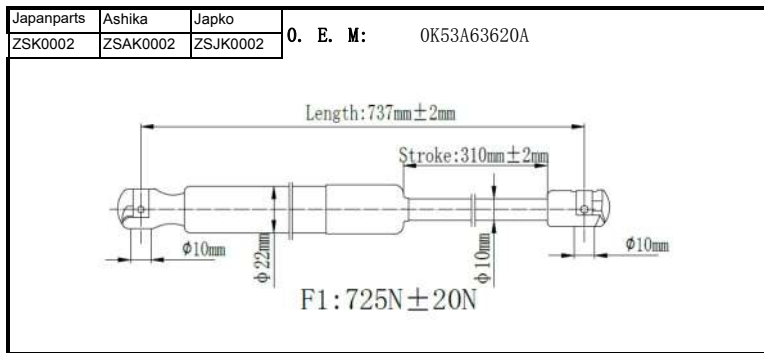
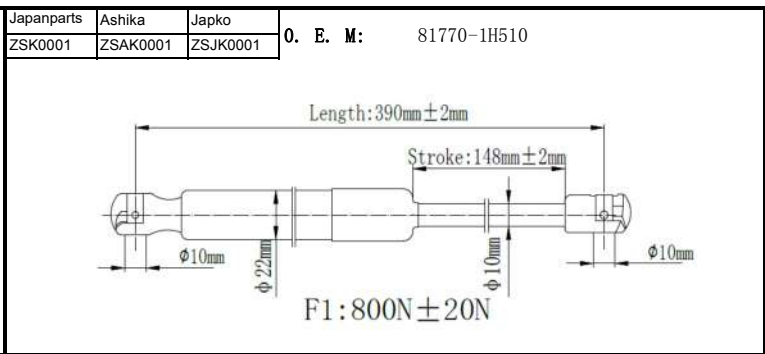
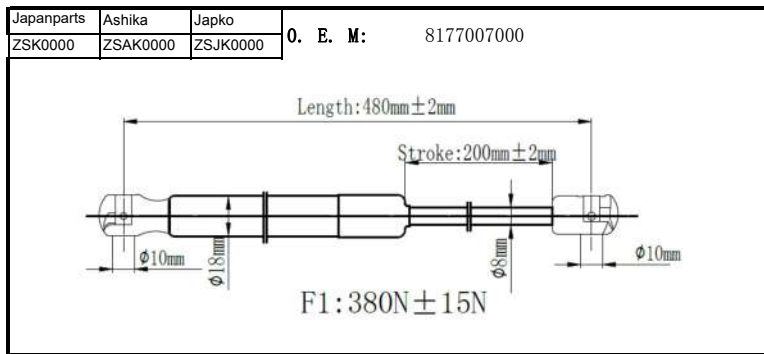

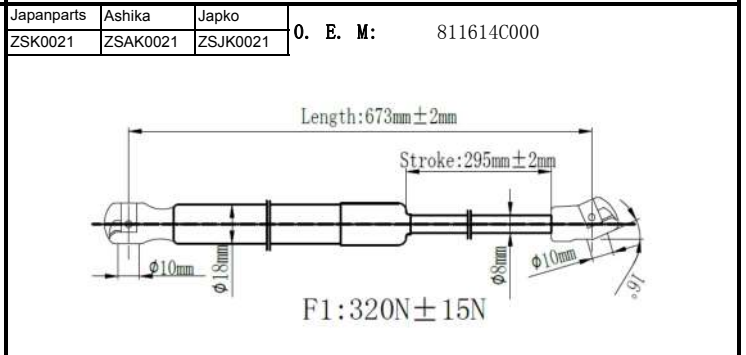
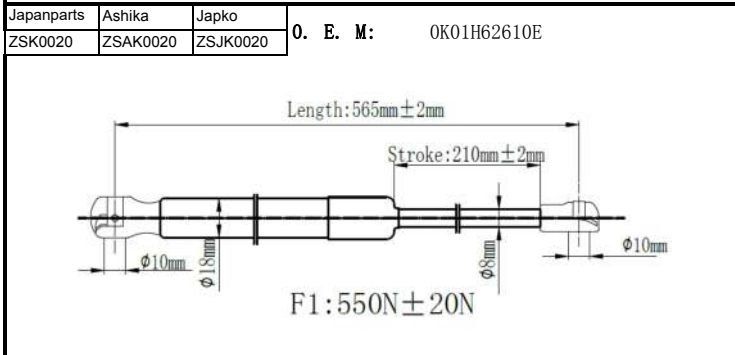
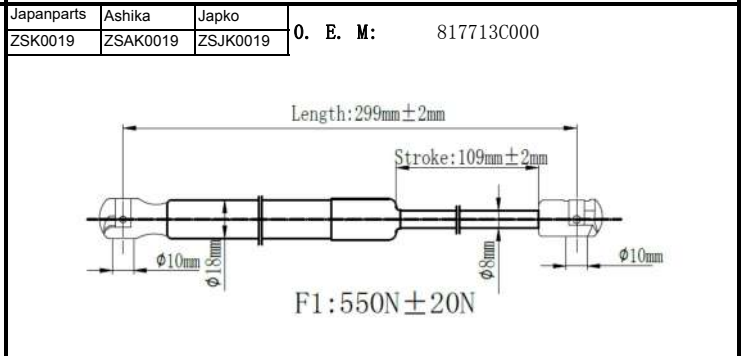
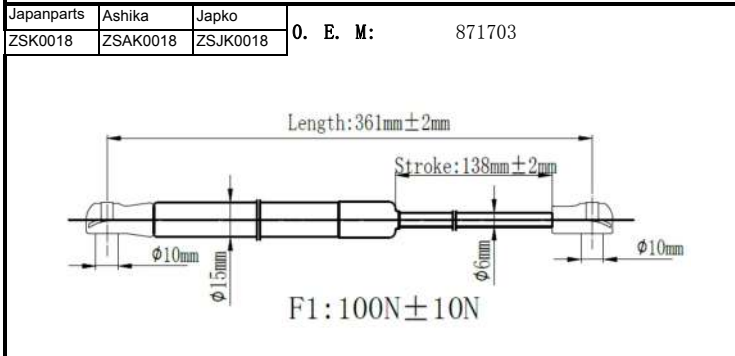
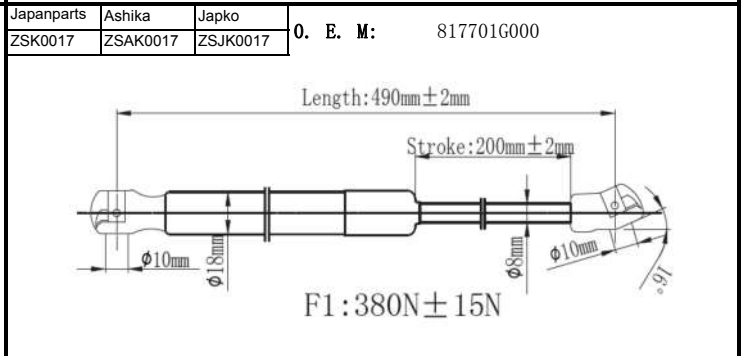
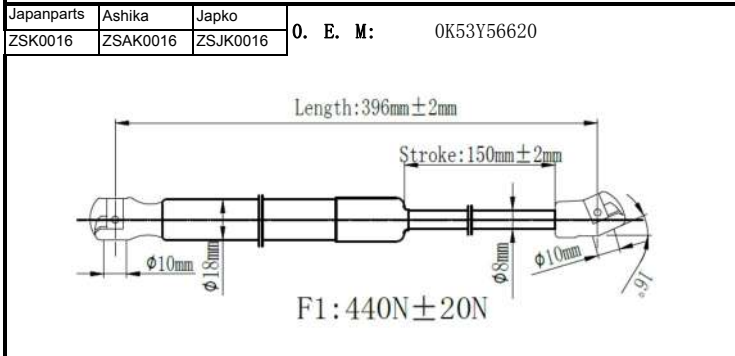
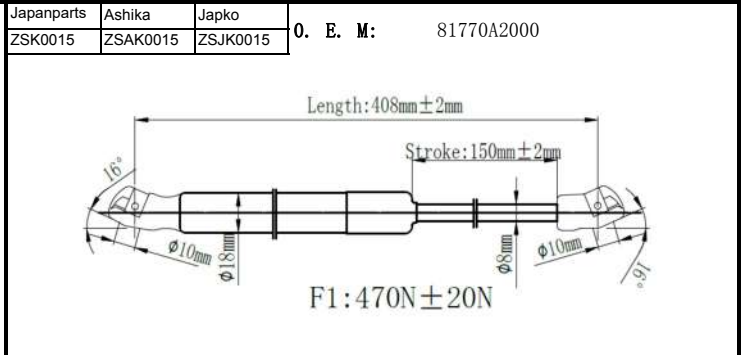
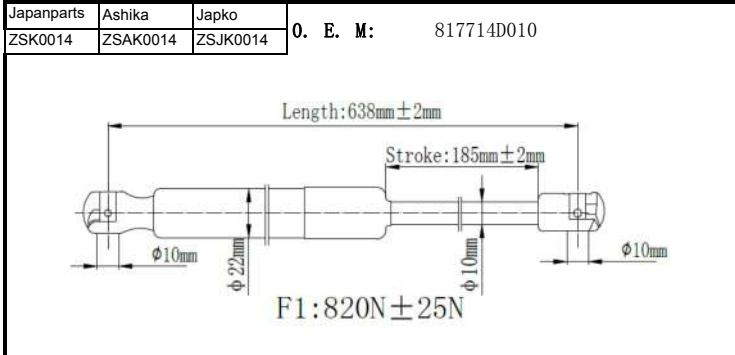
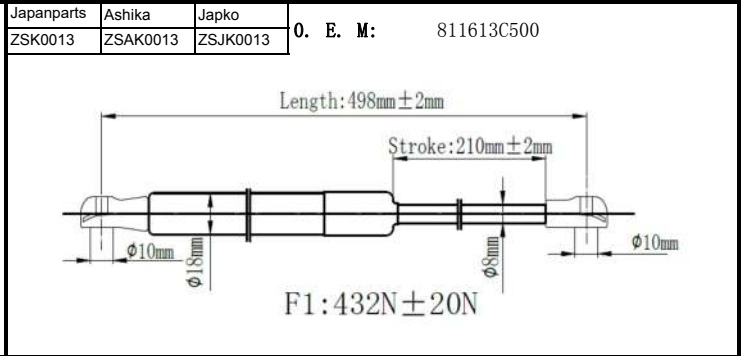
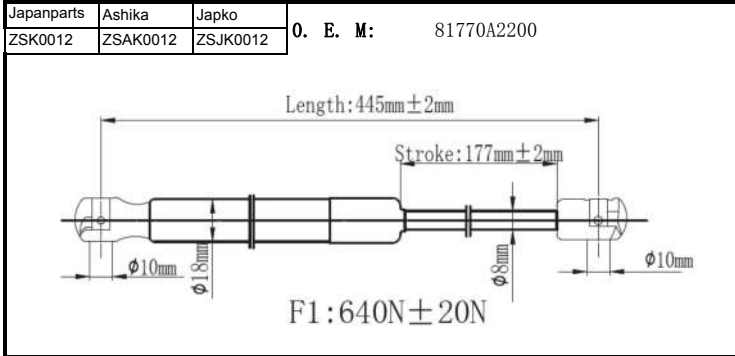
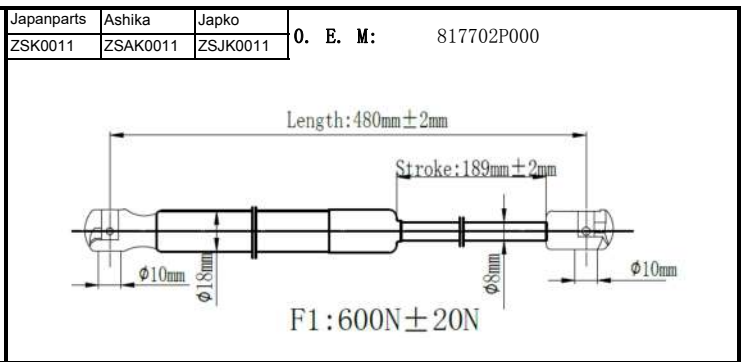
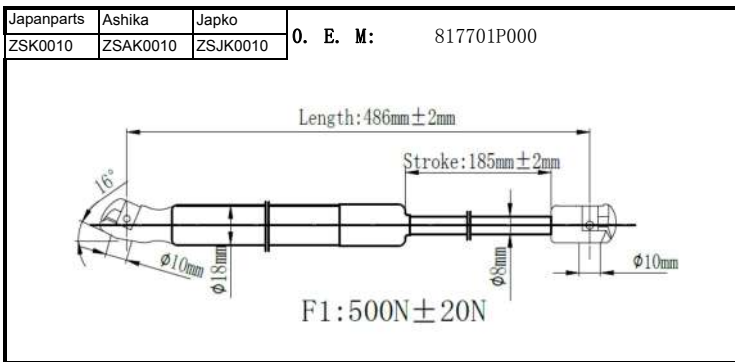

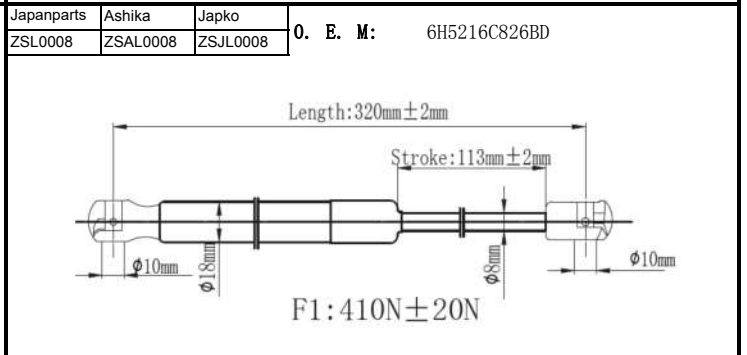
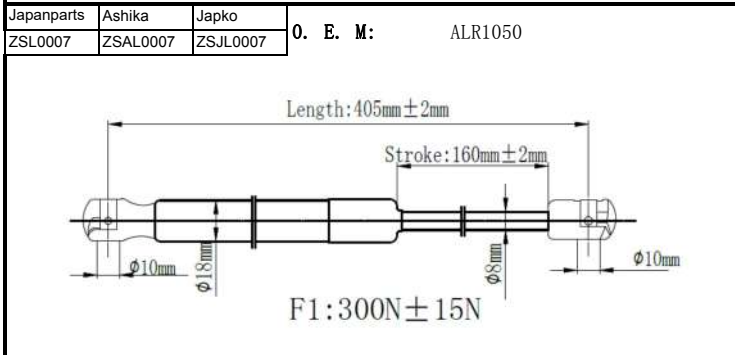
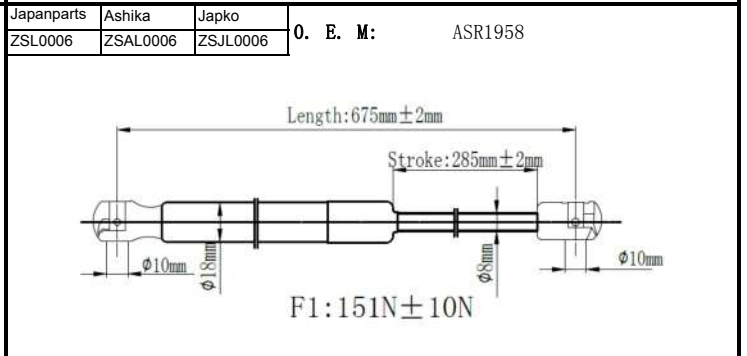
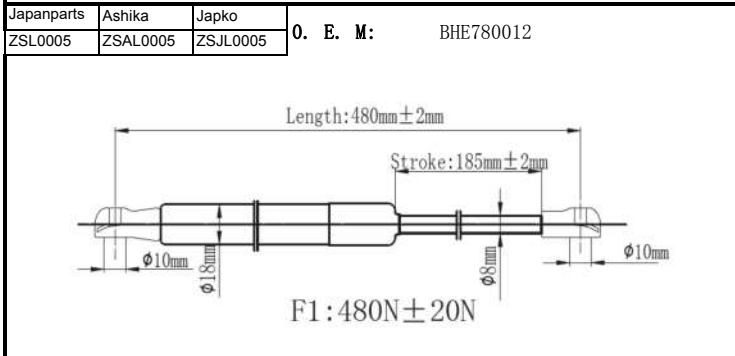
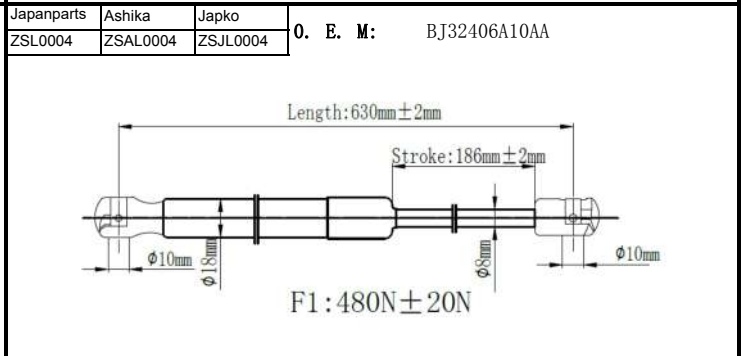
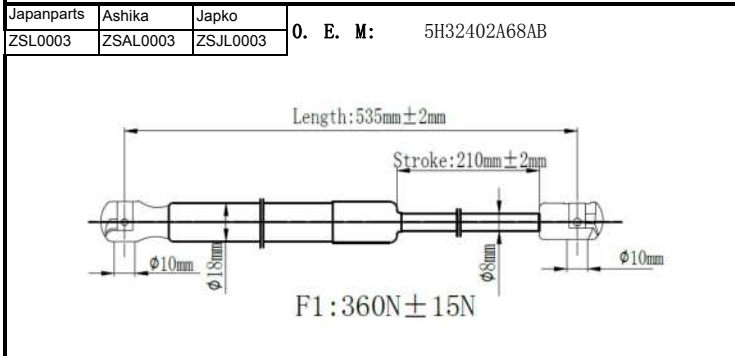
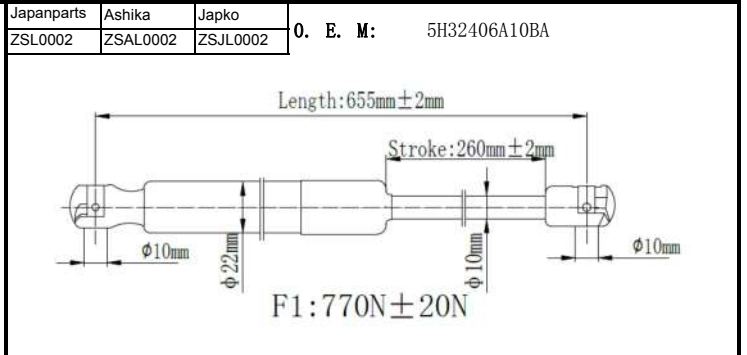
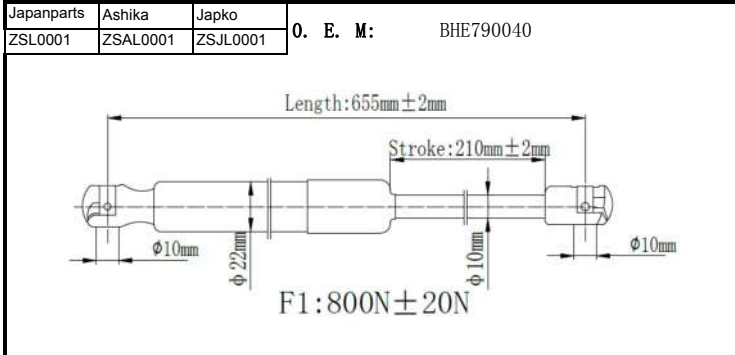
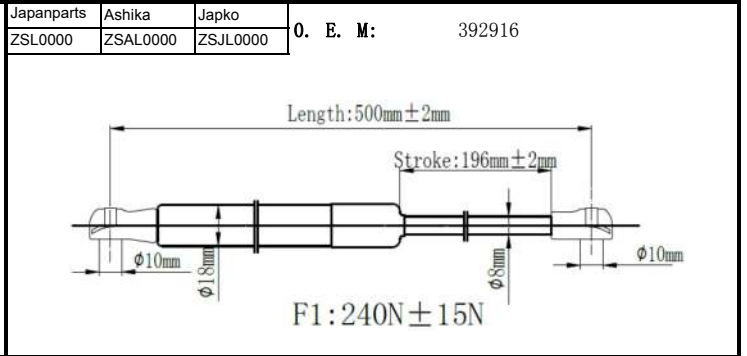
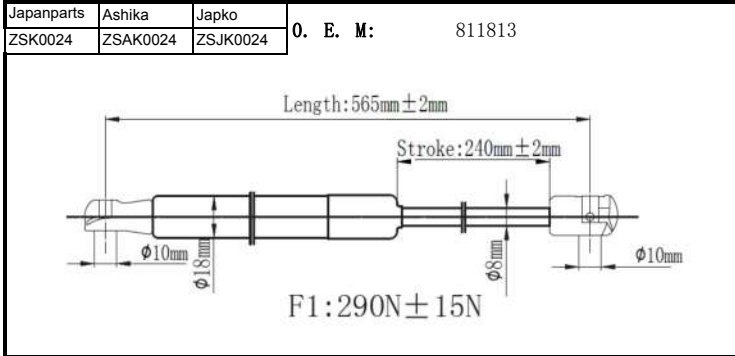
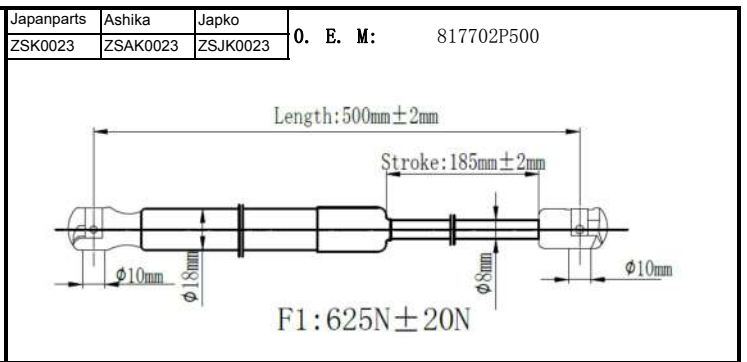
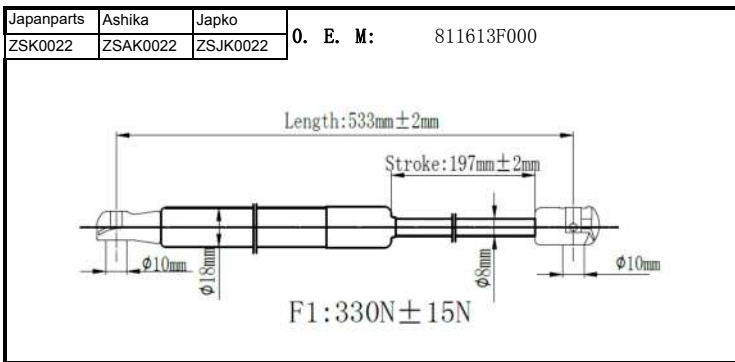

| | | |
|------------|----------|-----------|
| Japanparts | Ashika | Japko |
| ZSL0009 | ZSAL0009 | ZS JL0009 |

O. E. M.: 32028398

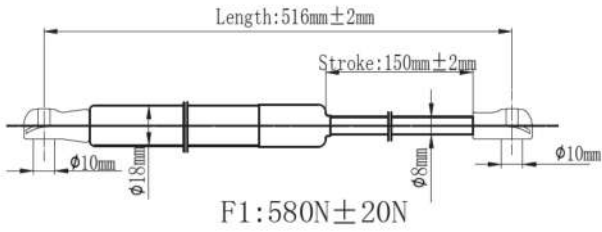

| | | |
|------------|----------|-----------|
| Japanparts | Ashika | Japko |
| ZSL0010 | ZSAL0010 | ZS JL0010 |

O. E. M.: BKK760010

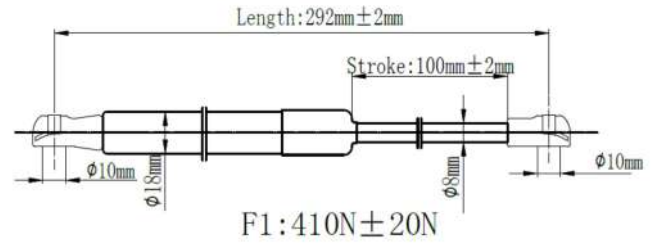

| | | |
|------------|----------|-----------|
| Japanparts | Ashika | Japko |
| ZSL0011 | ZSAL0011 | ZS JL0011 |

O. E. M.: BJ3216C826AA

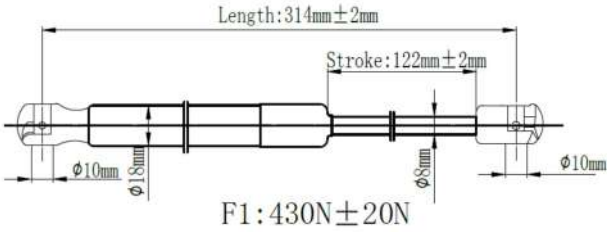

| | | |
|------------|----------|-----------|
| Japanparts | Ashika | Japko |
| ZSL0012 | ZSAL0012 | ZS JL0012 |

O. E. M.: 32030482

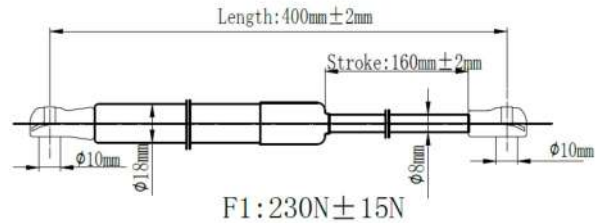

| | | |
|------------|----------|-----------|
| Japanparts | Ashika | Japko |
| ZSL0013 | ZSAL0013 | ZS JL0013 |

O. E. M.: CPLA406A10AA

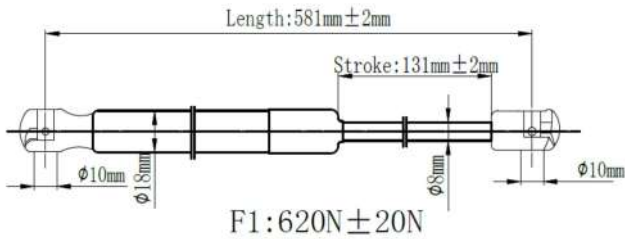

| | | |
|------------|----------|-----------|
| Japanparts | Ashika | Japko |
| ZSL0014 | ZSAL0014 | ZS JL0014 |

O. E. M.: 13241975

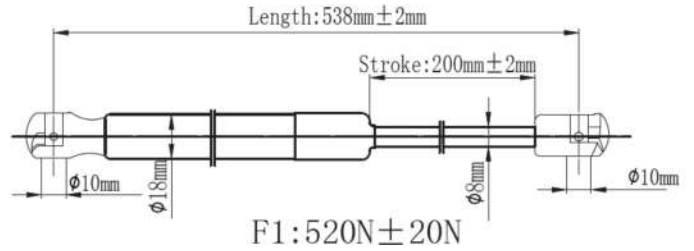

| | | |
|------------|----------|----------|
| Japanparts | Ashika | Japko |
| ZSM0000 | ZSAM0000 | ZSJM0000 |

O. E. M.: 0000618V007000000

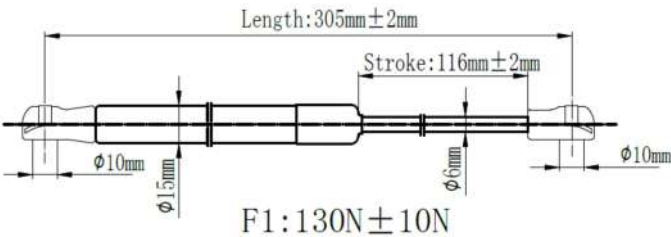

| | | |
|------------|----------|----------|
| Japanparts | Ashika | Japko |
| ZSM0001 | ZSAM0001 | ZSJM0001 |

O. E. M.: 4547400145

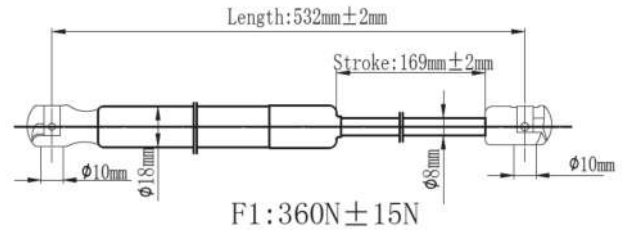

| | | |
|------------|----------|----------|
| Japanparts | Ashika | Japko |
| ZSM0002 | ZSAM0002 | ZSJM0002 |

O. E. M.: A4519880004

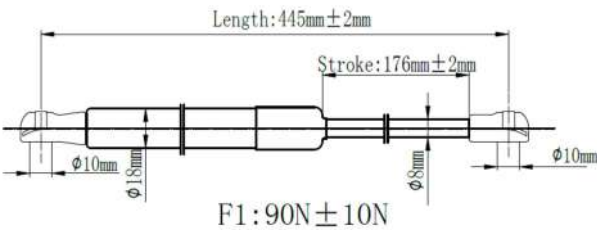

| | | |
|------------|----------|----------|
| Japanparts | Ashika | Japko |
| ZSM0003 | ZSAM0003 | ZSJM0003 |

O. E. M.: Q0009235V004000000

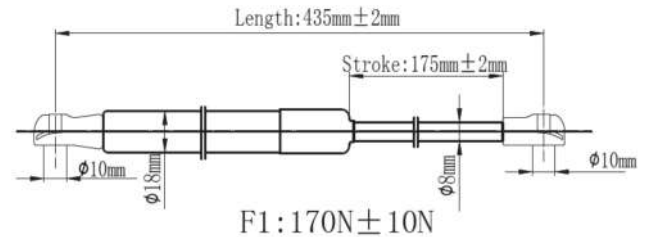

| | | |
|------------|----------|----------|
| Japanparts | Ashika | Japko |
| ZSS0000 | ZSAS0000 | ZSJS0000 |

O. E. M.: 7115008100

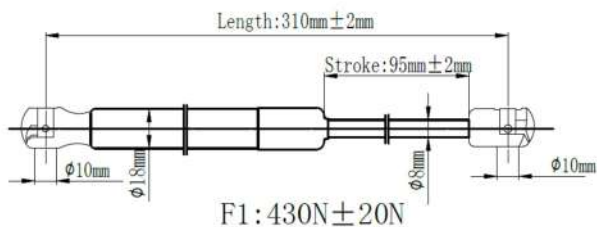

| | | |
|------------|----------|----------|
| Japanparts | Ashika | Japko |
| ZSS0001 | ZSAS0001 | ZSJS0001 |

O. E. M.: 7115009000

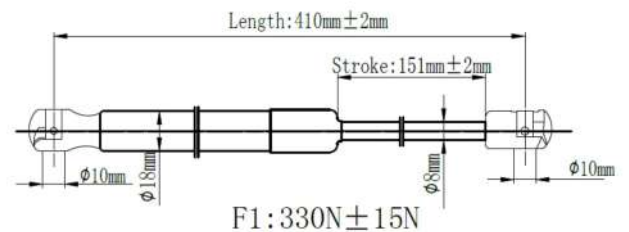

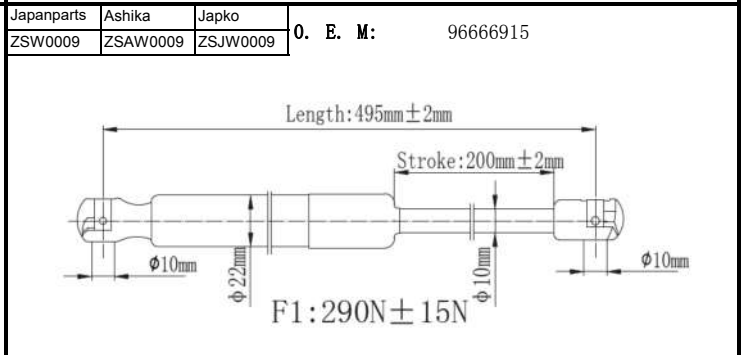
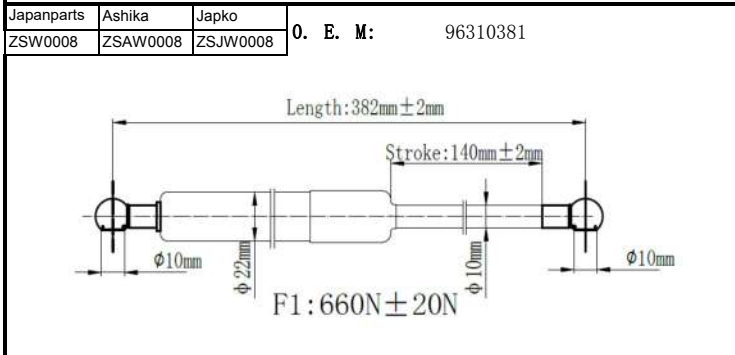
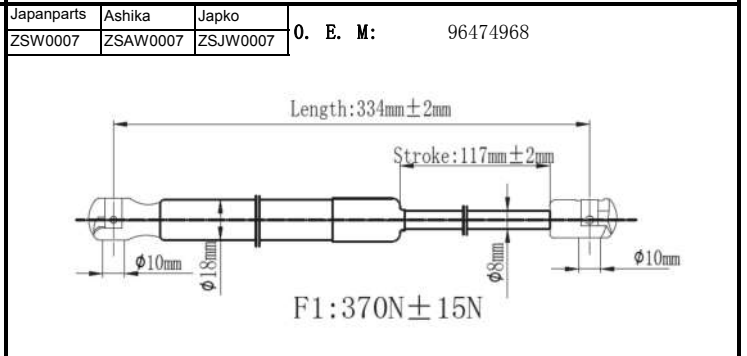
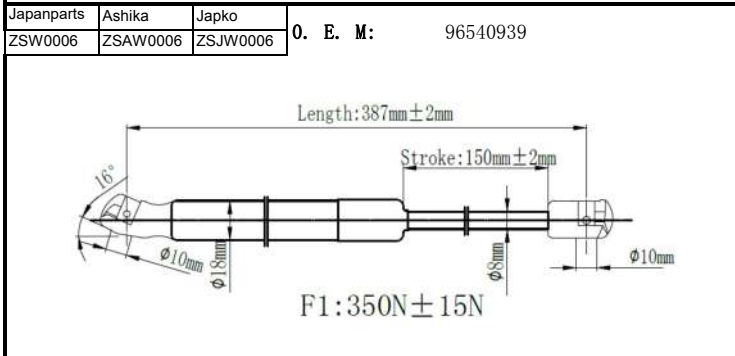
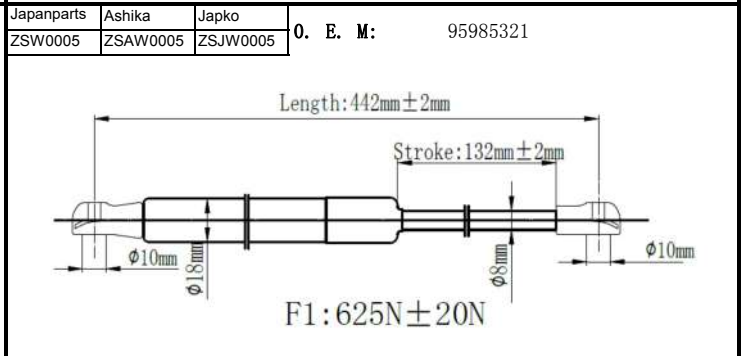
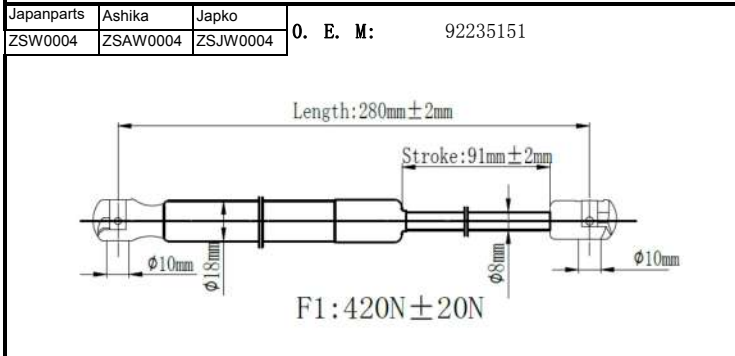
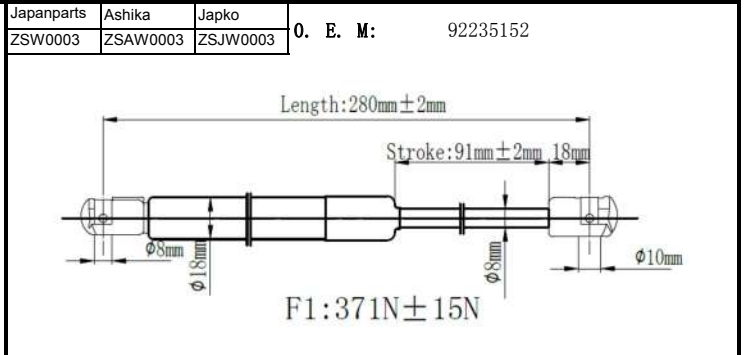
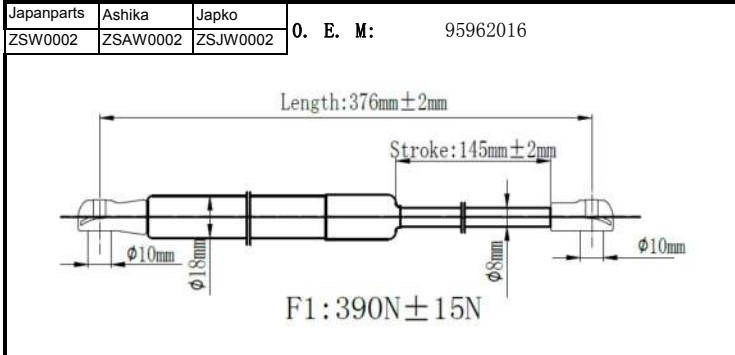
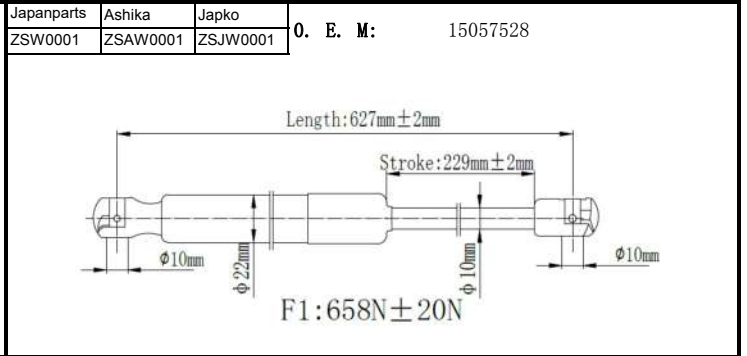
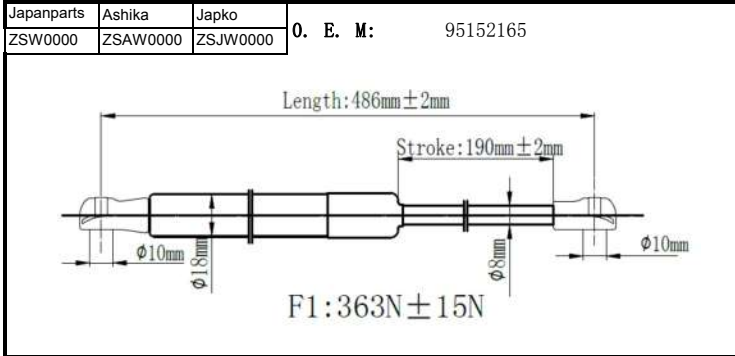
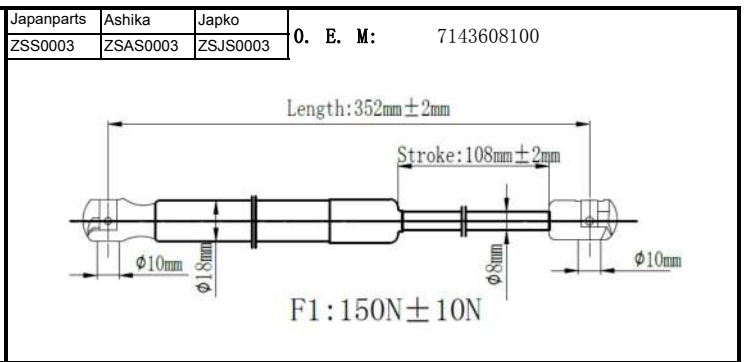
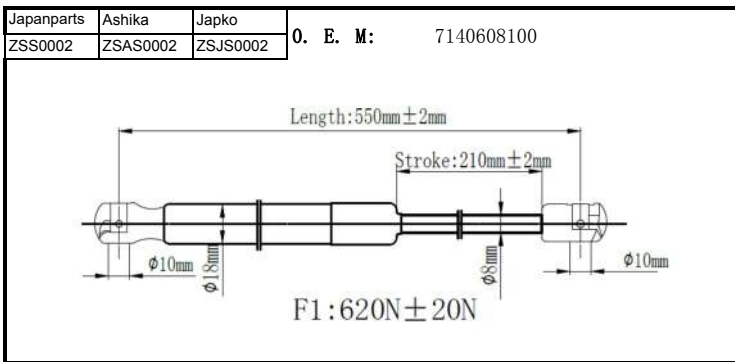

| | | |
|------------|----------|----------|
| Japanparts | Ashika | Japko |
| ZSW0010 | ZSAW0010 | ZSJW0010 |

O. E. M.: 0

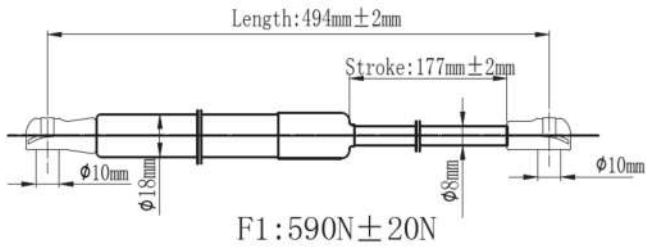

| | | |
|------------|----------|----------|
| Japanparts | Ashika | Japko |
| ZSW0011 | ZSAW0011 | ZSJW0011 |

O. E. M.: 96617850

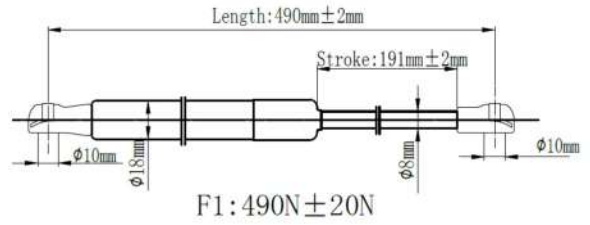

| | | |
|------------|----------|----------|
| Japanparts | Ashika | Japko |
| ZSW0012 | ZSAW0012 | ZSJW0012 |

O. E. M.: 96548931

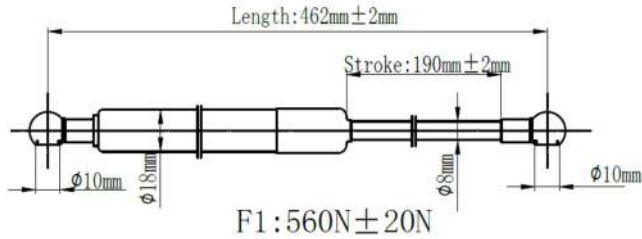

| | | |
|------------|----------|----------|
| Japanparts | Ashika | Japko |
| ZSW0013 | ZSAW0013 | ZSJW0013 |

O. E. M.: 95146515

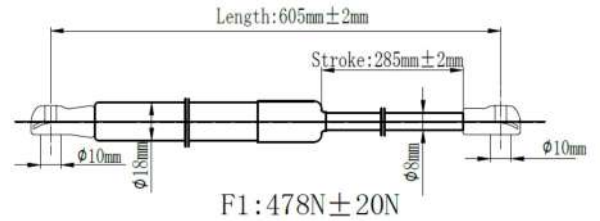

| | | |
|------------|----------|----------|
| Japanparts | Ashika | Japko |
| ZSW0014 | ZSAW0014 | ZSJW0014 |

O. E. M.: 95472696

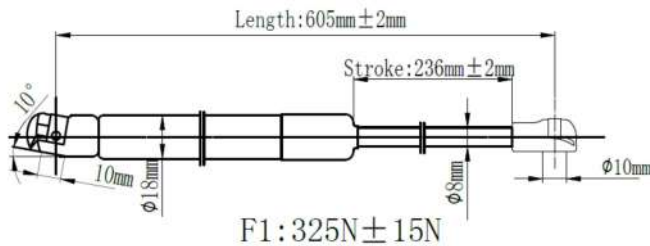

| | | |
|------------|----------|----------|
| Japanparts | Ashika | Japko |
| ZSW0015 | ZSAW0015 | ZSJW0015 |

O. E. M.: 96306833

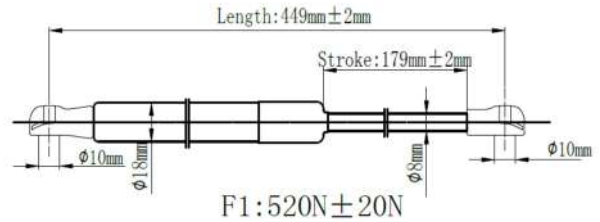

| | | |
|------------|----------|----------|
| Japanparts | Ashika | Japko |
| ZSW0016 | ZSAW0016 | ZSJW0016 |

O. E. M.: 96306157

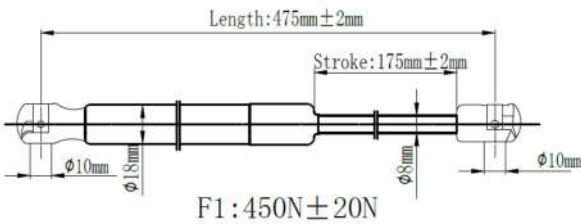

| | | |
|------------|----------|----------|
| Japanparts | Ashika | Japko |
| ZSW0017 | ZSAW0017 | ZSJW0017 |

O. E. M.: 96301822

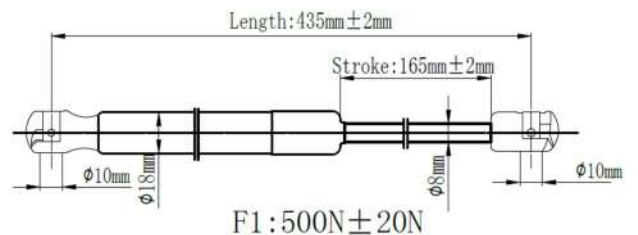

| | | |
|------------|----------|----------|
| Japanparts | Ashika | Japko |
| ZSW0018 | ZSAW0018 | ZSJW0018 |

O. E. M.: 90159607

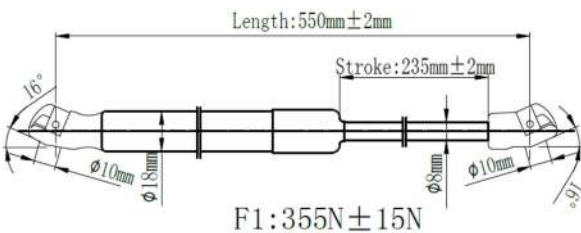

| | | |
|------------|----------|----------|
| Japanparts | Ashika | Japko |
| ZSW0019 | ZSAW0019 | ZSJW0019 |

O. E. M.: 15162860

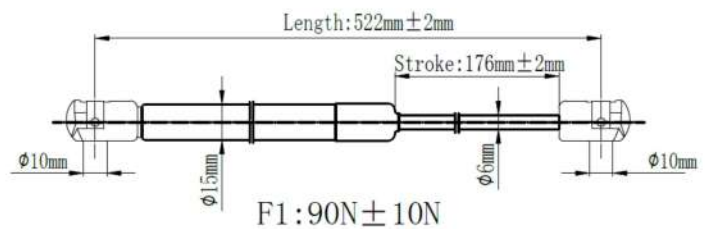

| | | |
|------------|----------|----------|
| Japanparts | Ashika | Japko |
| ZSW0020 | ZSAW0020 | ZSJW0020 |

O. E. M.: 15287684

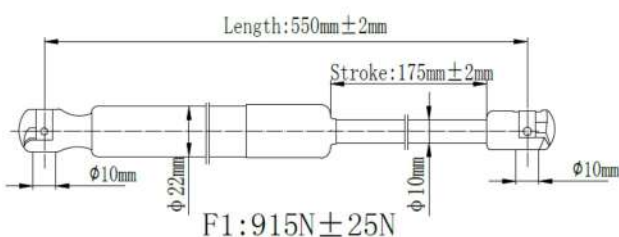

| | | |
|------------|----------|----------|
| Japanparts | Ashika | Japko |
| ZSW0021 | ZSAW0021 | ZSJW0021 |

O. E. M.: 15827845

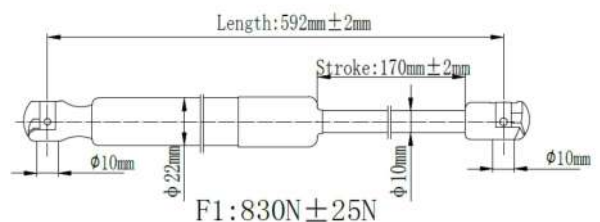

| | | |
|------------|----------|----------|
| Japanparts | Ashika | Japko |
| ZSW0022 | ZSAW0022 | ZSJW0022 |

O. E. M.: 4809275

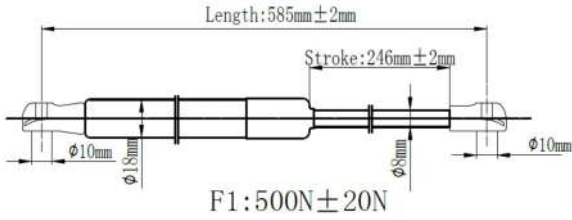

| | | |
|------------|----------|----------|
| Japanparts | Ashika | Japko |
| ZSW0023 | ZSAW0023 | ZSJW0023 |

O. E. M.: 132741

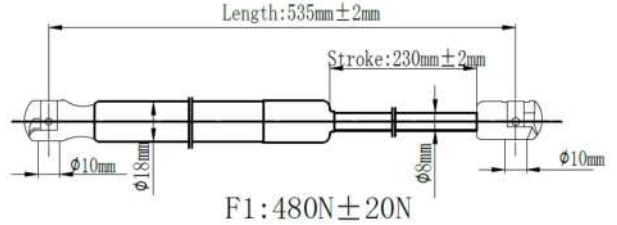

| | | |
|------------|----------|----------|
| Japanparts | Ashika | Japko |
| ZSW0024 | ZSAW0024 | ZSJW0024 |

O. E. M.: 132677

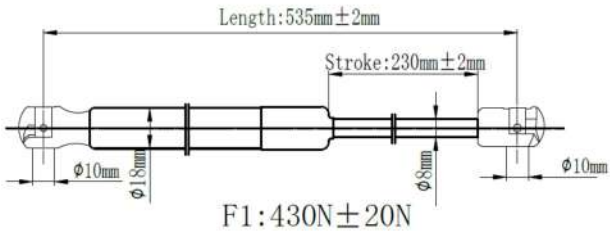

| | | |
|------------|----------|----------|
| Japanparts | Ashika | Japko |
| ZSW0025 | ZSAW0025 | ZSJW0025 |

O. E. M.: 132739

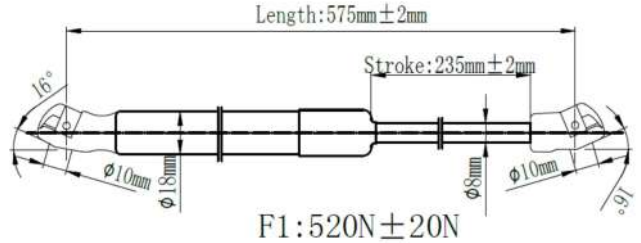

| | | |
|------------|----------|----------|
| Japanparts | Ashika | Japko |
| ZSW0026 | ZSAW0026 | ZSJW0026 |

O. E. M.: 1180405

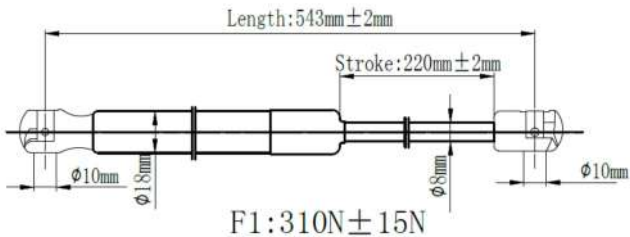

| | | |
|------------|----------|----------|
| Japanparts | Ashika | Japko |
| ZSW0027 | ZSAW0027 | ZSJW0027 |

O. E. M.: 132743

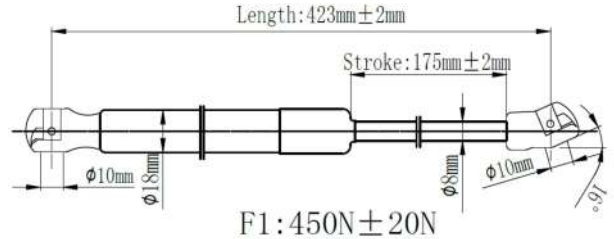

| | | |
|------------|----------|----------|
| Japanparts | Ashika | Japko |
| ZSW0028 | ZSAW0028 | ZSJW0028 |

O. E. M.: 13182537

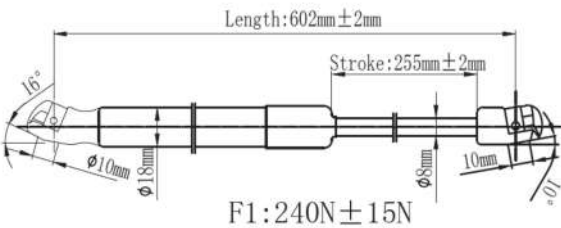

| | | |
|------------|----------|----------|
| Japanparts | Ashika | Japko |
| ZSW0029 | ZSAW0029 | ZSJW0029 |

O. E. M.: 22714717

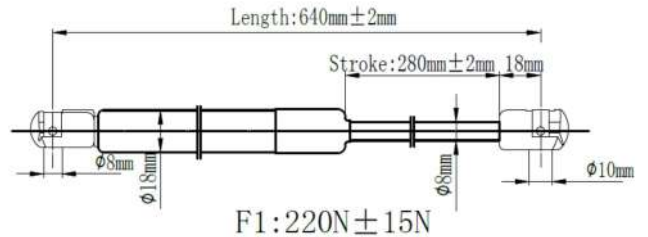

| | | |
|------------|----------|----------|
| Japanparts | Ashika | Japko |
| ZSW0030 | ZSAW0030 | ZSJW0030 |

O. E. M.: 4539800164

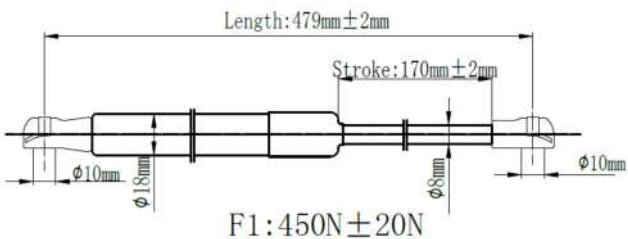

| | | |
|------------|----------|----------|
| Japanparts | Ashika | Japko |
| ZSW0031 | ZSAW0031 | ZSJW0031 |

O. E. M.: 15833919

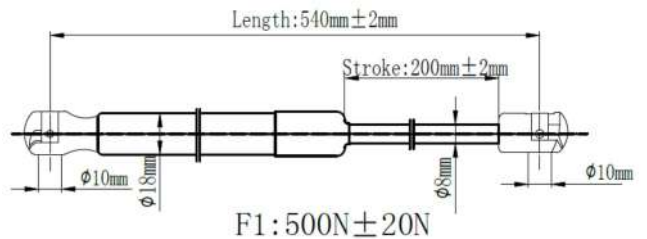

| | | |
|------------|----------|----------|
| Japanparts | Ashika | Japko |
| ZSW0032 | ZSAW0032 | ZSJW0032 |

O. E. M.: 15836654

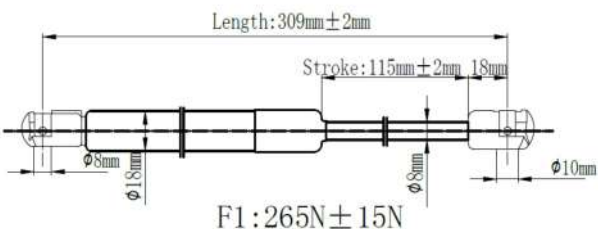

| | | |
|------------|----------|----------|
| Japanparts | Ashika | Japko |
| ZSW0033 | ZSAW0033 | ZSJW0033 |

O. E. M.: 15855373

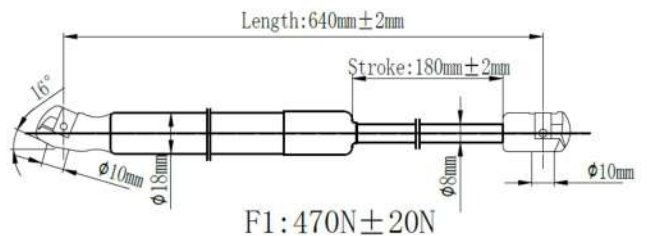

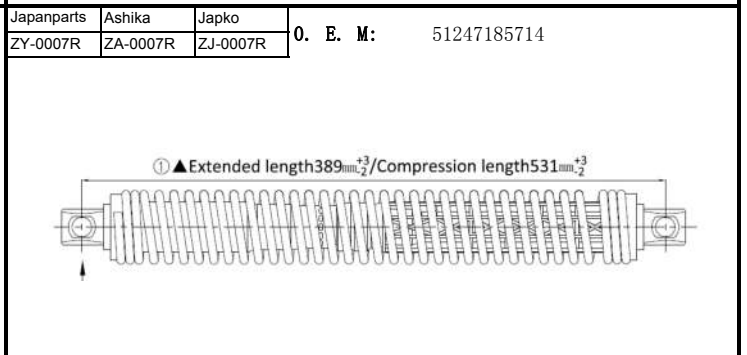
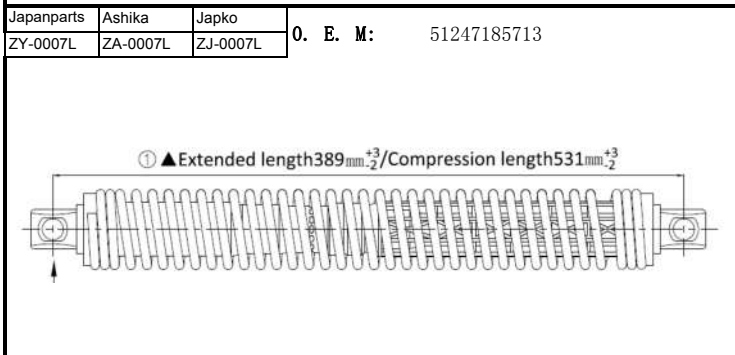
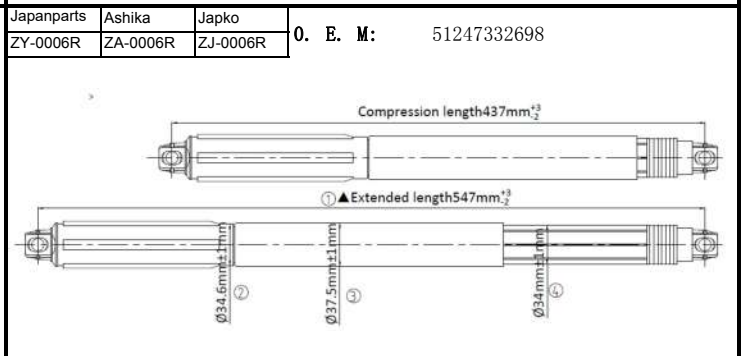
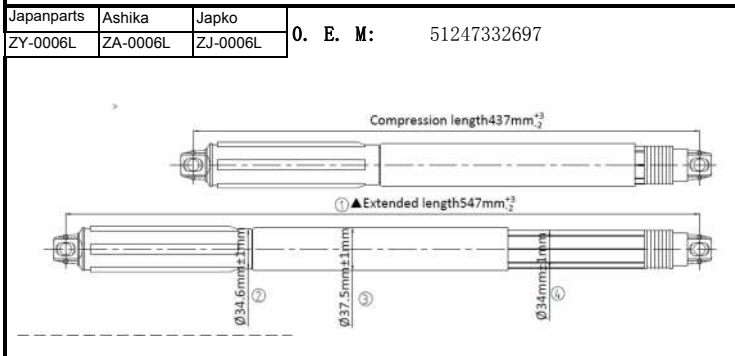
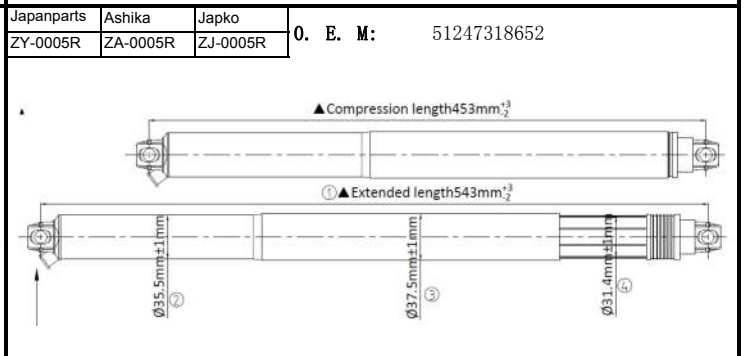
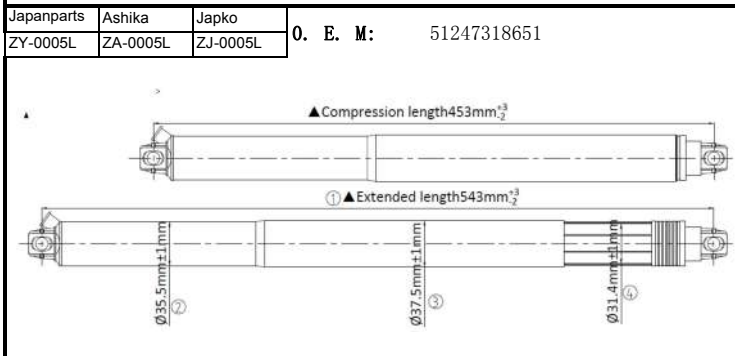
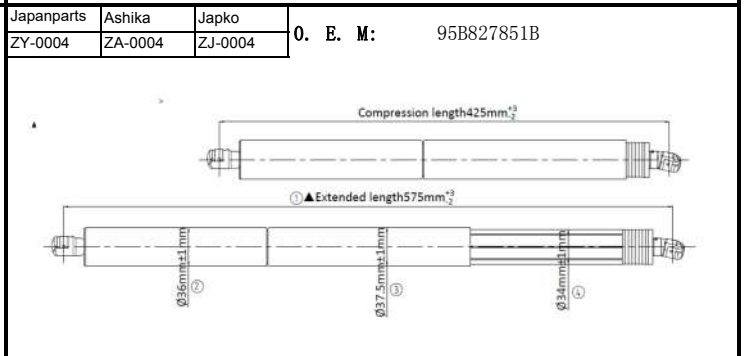
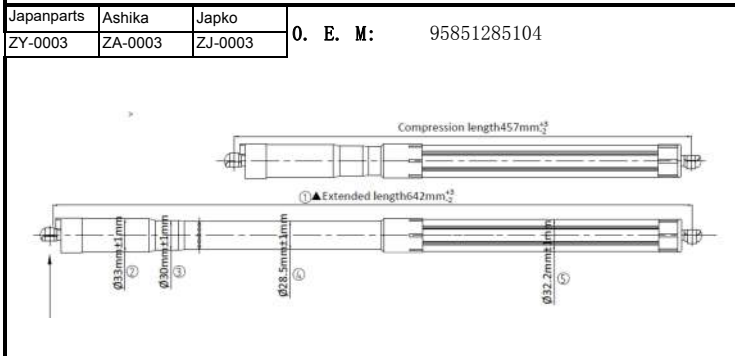
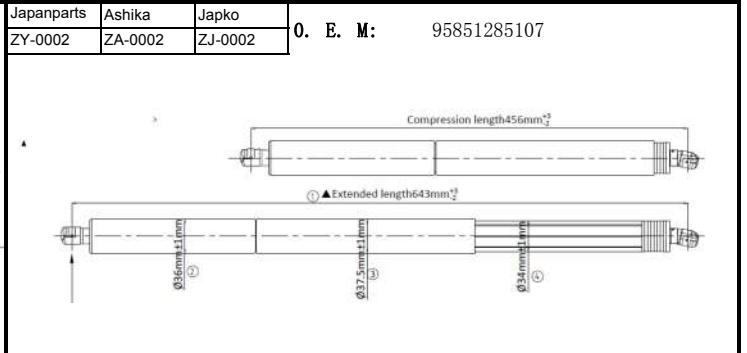
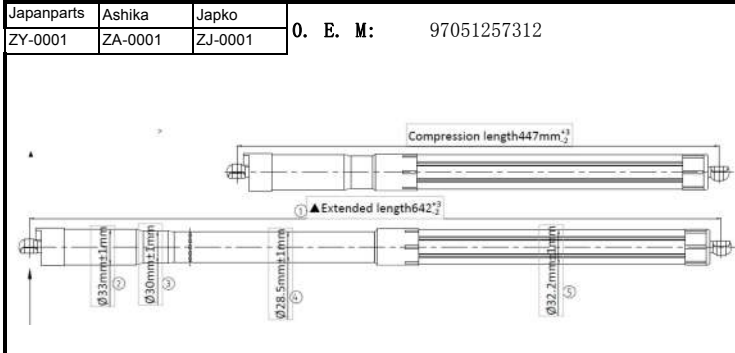
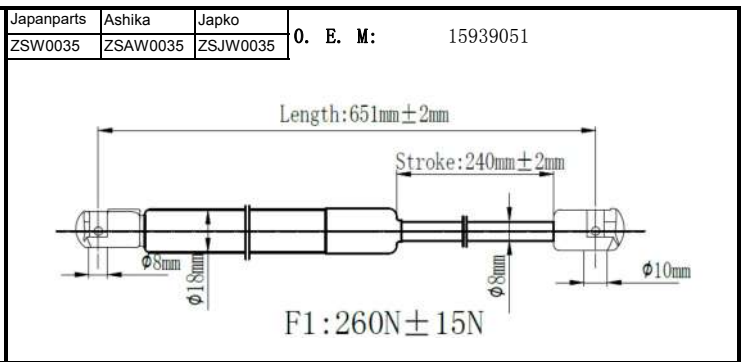
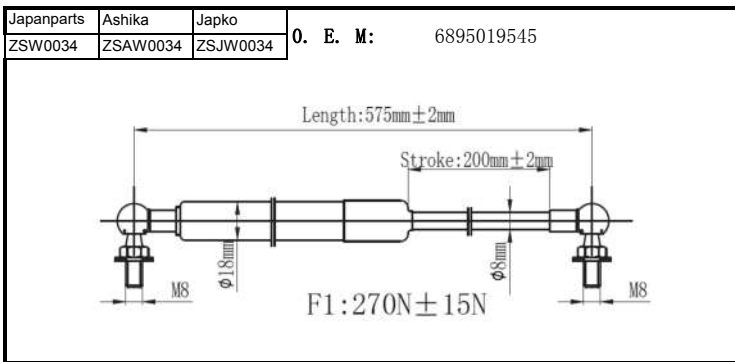

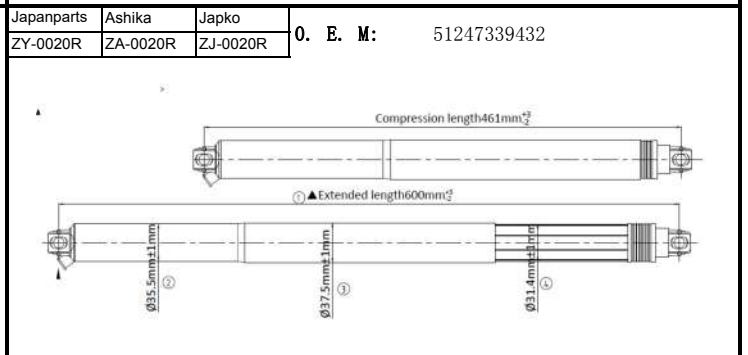
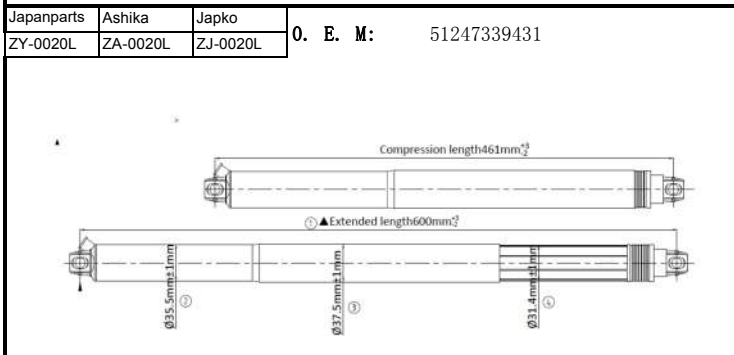
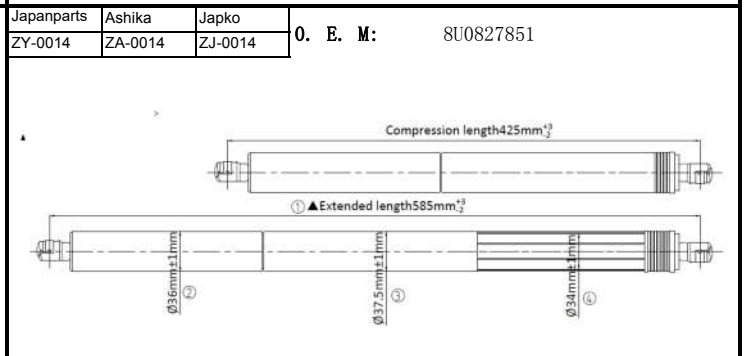
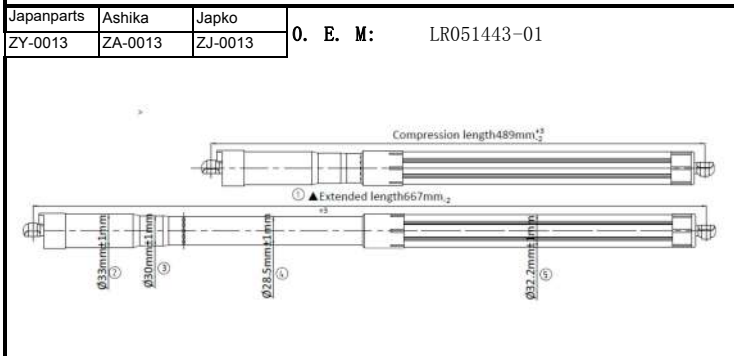
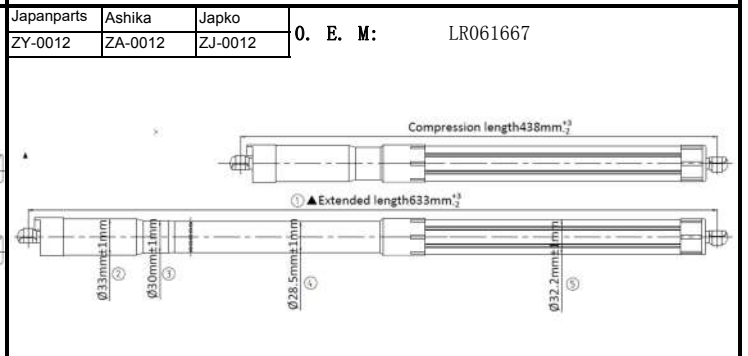
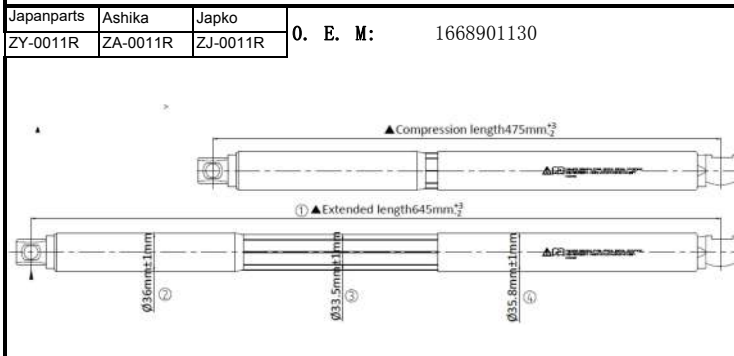
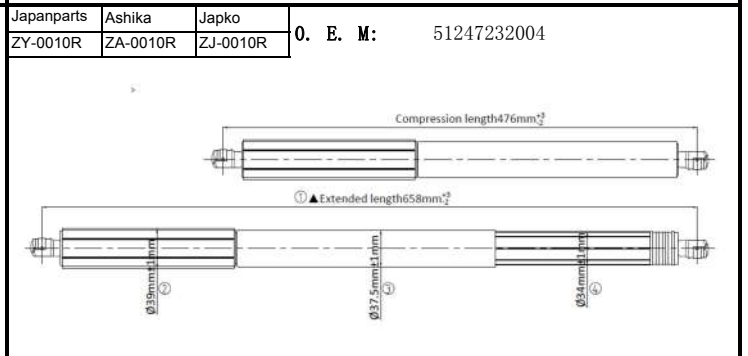
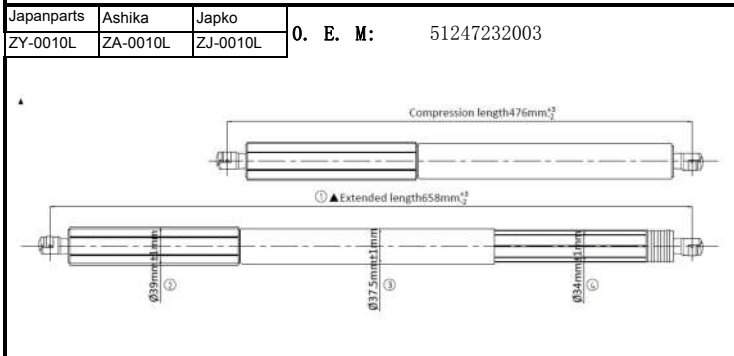
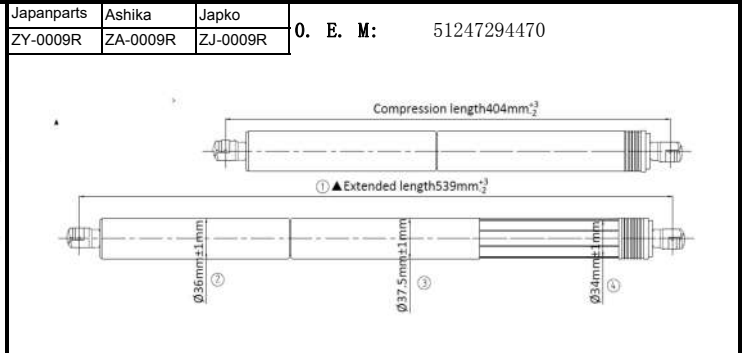
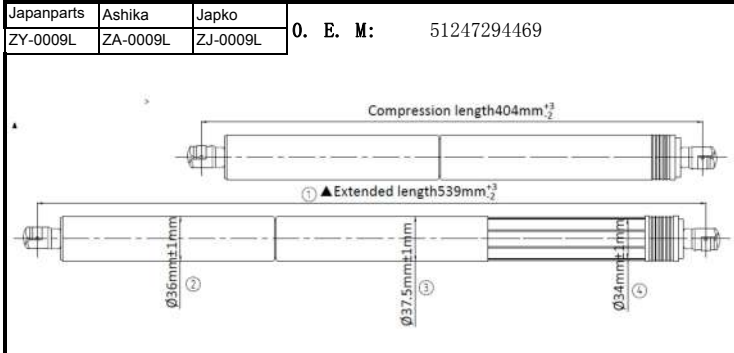
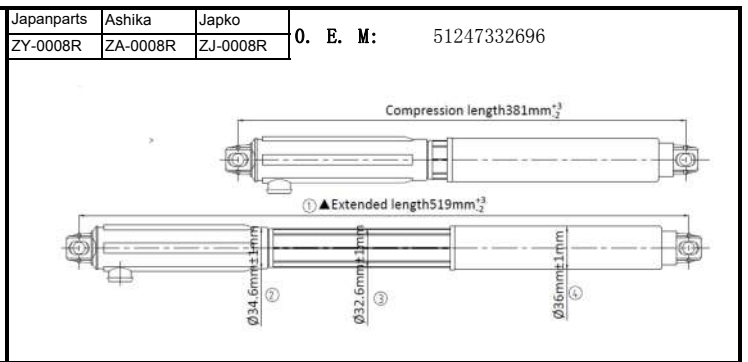
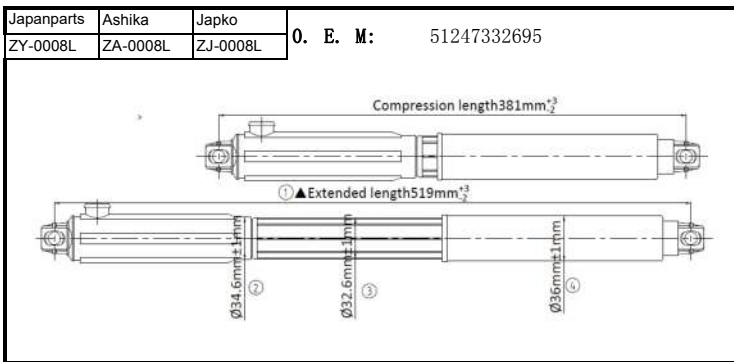

| | | |
|------------|---------|---------|
| Japanparts | Ashika | Japko |
| ZY-0025 | ZA-0025 | ZJ-0025 |

O. E. M.: 22895254

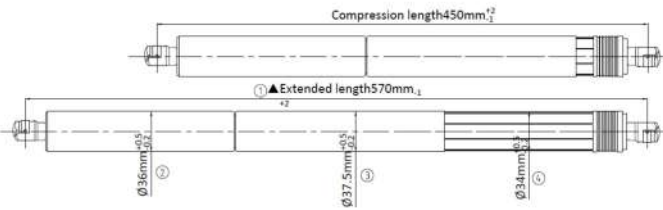

| | | |
|------------|----------|----------|
| Japanparts | Ashika | Japko |
| ZY-0086L | ZA-0086L | ZJ-0086L |

O. E. M.: 31386705

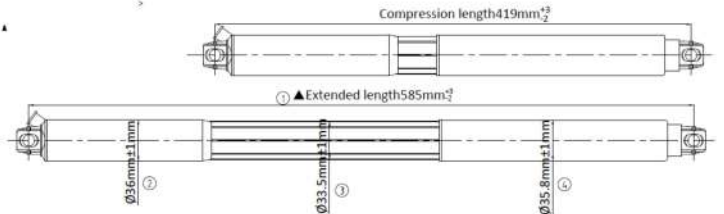

| | | |
|------------|----------|----------|
| Japanparts | Ashika | Japko |
| ZY-0086R | ZA-0086R | ZJ-0086R |

O. E. M.: 31386706

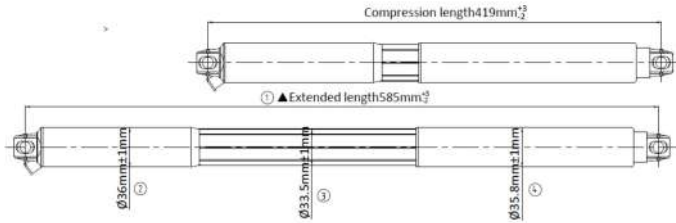

| | | |
|------------|---------|---------|
| Japanparts | Ashika | Japko |
| ZY-0097 | ZA-0097 | ZJ-0097 |

O. E. M.: LR044161

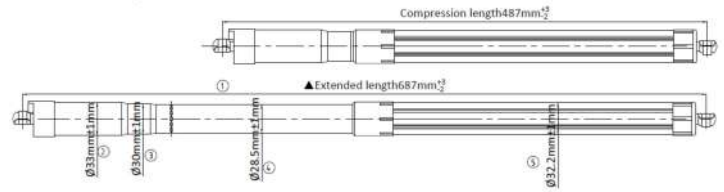

| | | |
|------------|---------|---------|
| Japanparts | Ashika | Japko |
| ZY-0099 | ZA-0099 | ZJ-0099 |

O. E. M.:

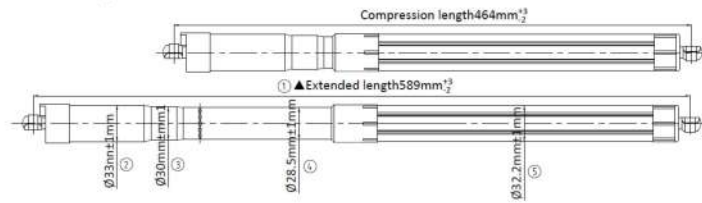

| | | |
|------------|---------|---------|
| Japanparts | Ashika | Japko |
| ZY-0100 | ZA-0100 | ZJ-0100 |

O. E. M.: LR075420

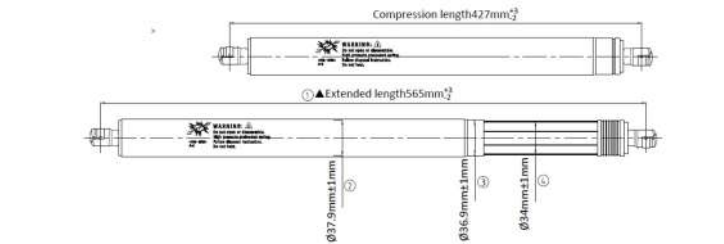

| | | |
|------------|---------|---------|
| Japanparts | Ashika | Japko |
| ZY-0102 | ZA-0102 | ZJ-0102 |

O. E. M.: 7P6827851D

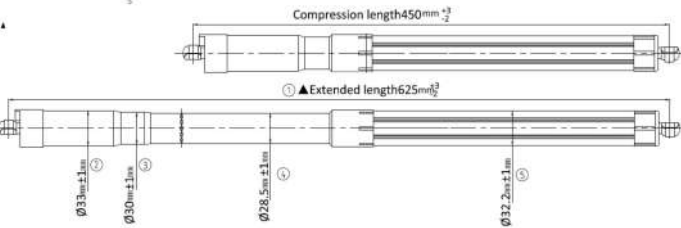

| | | |
|------------|---------|---------|
| Japanparts | Ashika | Japko |
| ZY-0106 | ZA-0106 | ZJ-0106 |

O. E. M.: 5N827851A

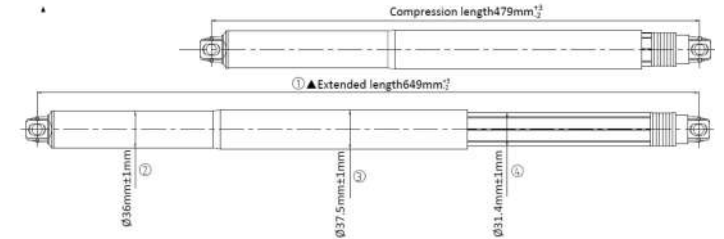

| | | |
|------------|---------|---------|
| Japanparts | Ashika | Japko |
| ZY-0109 | ZA-0109 | ZJ-0109 |

O. E. M.: 7N0827851E

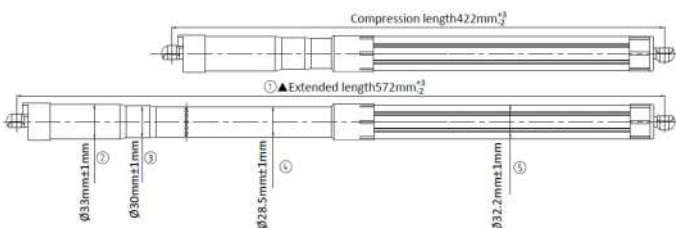

| | | |
|------------|----------|----------|
| Japanparts | Ashika | Japko |
| ZY-0110R | ZA-0110R | ZJ-0110R |

O. E. M.: 51247397322

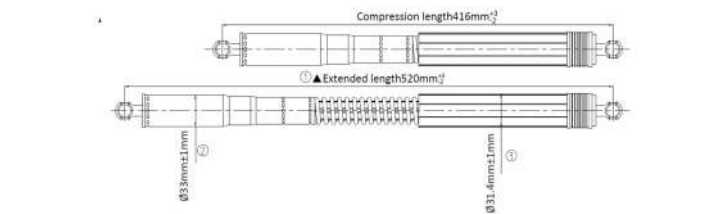

| | | |
|------------|----------|----------|
| Japanparts | Ashika | Japko |
| ZY-0111L | ZA-0111L | ZJ-0111L |

O. E. M.: 51247298983

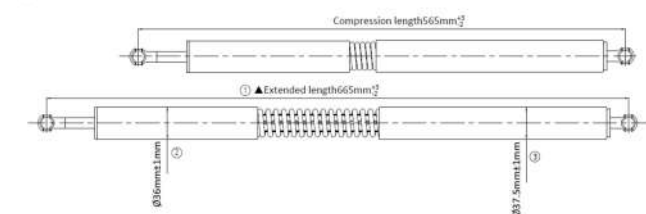

| | | |
|------------|----------|----------|
| Japanparts | Ashika | Japko |
| ZY-0111R | ZA-0111R | ZJ-0111R |

O. E. M.: 51247298984

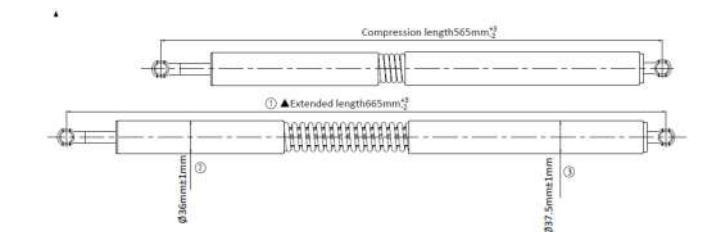

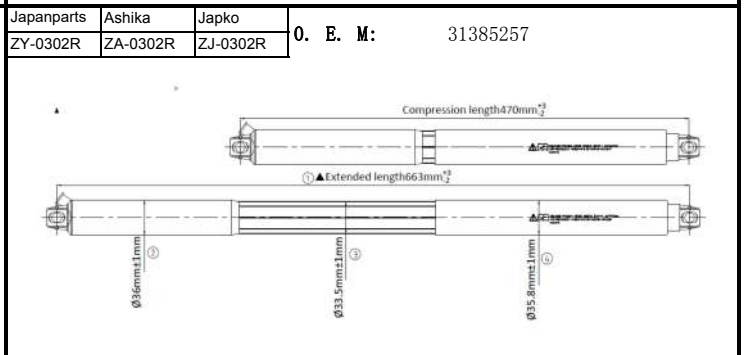
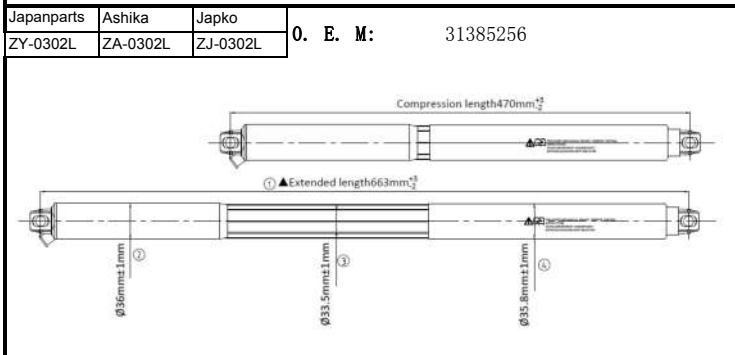
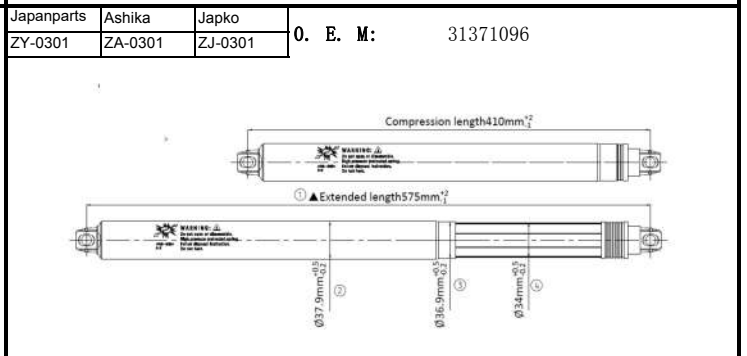
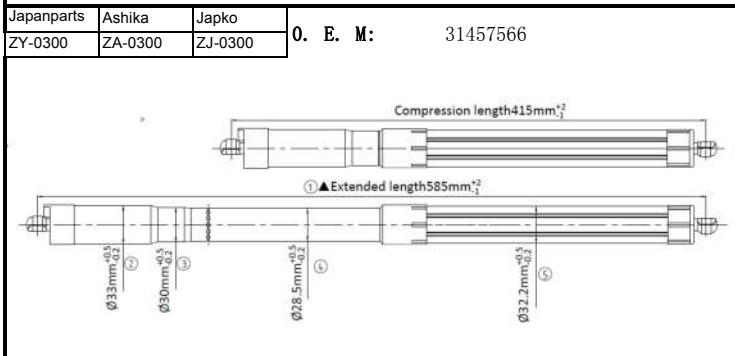
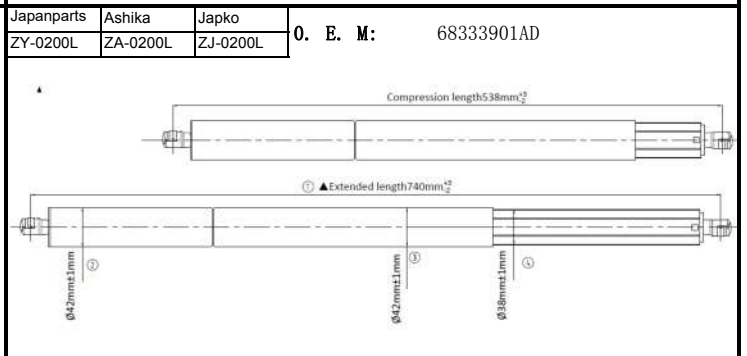
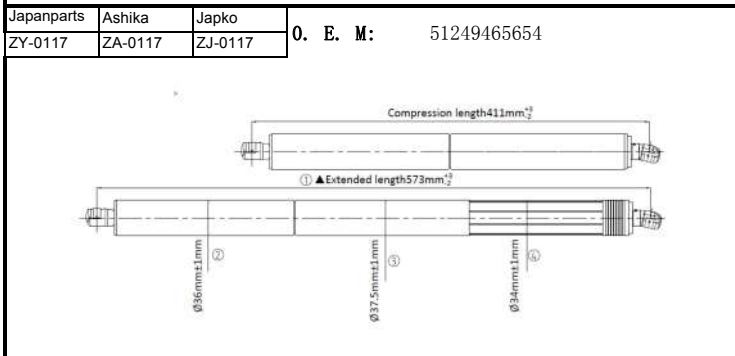
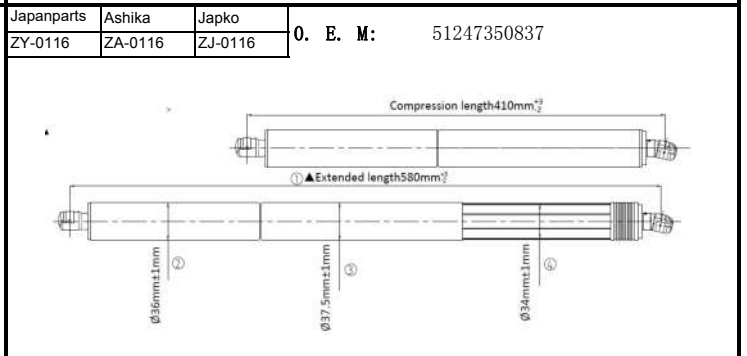
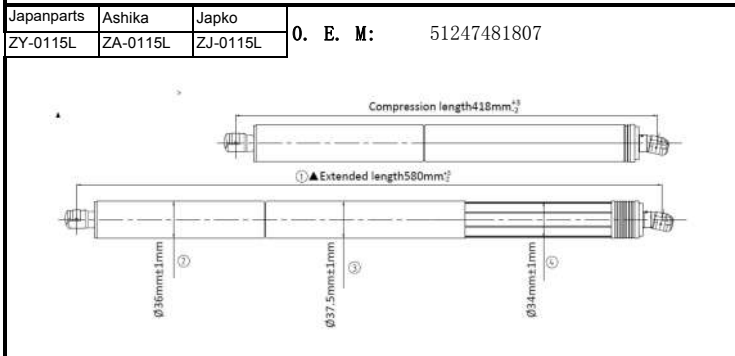
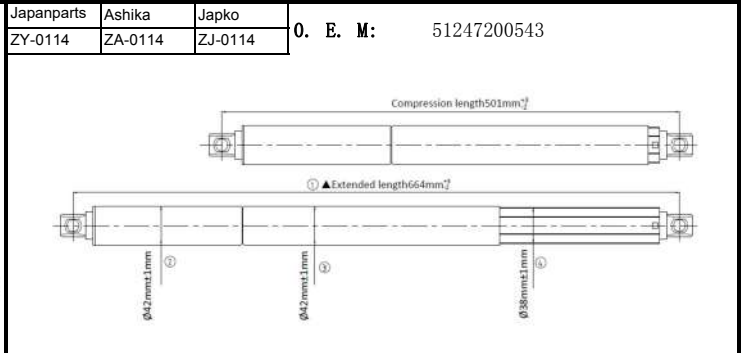
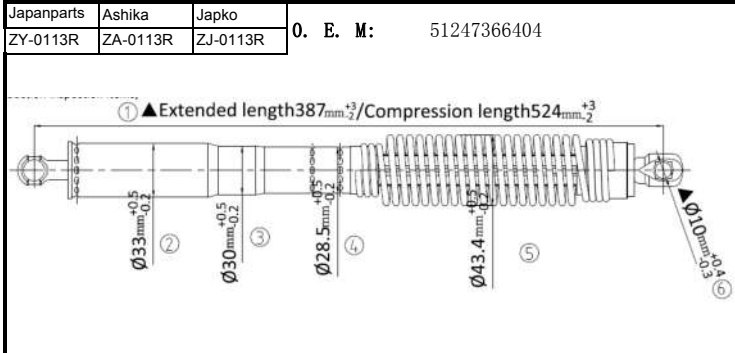
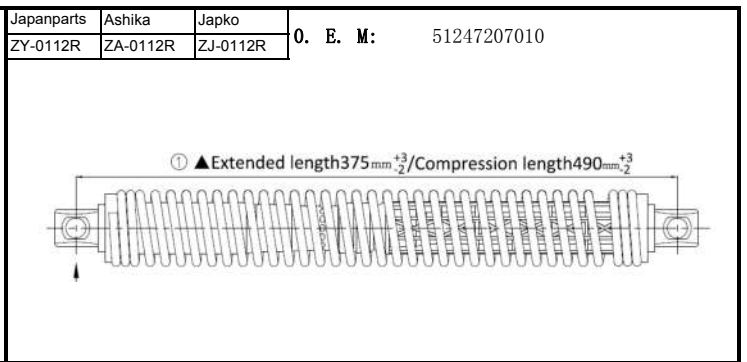
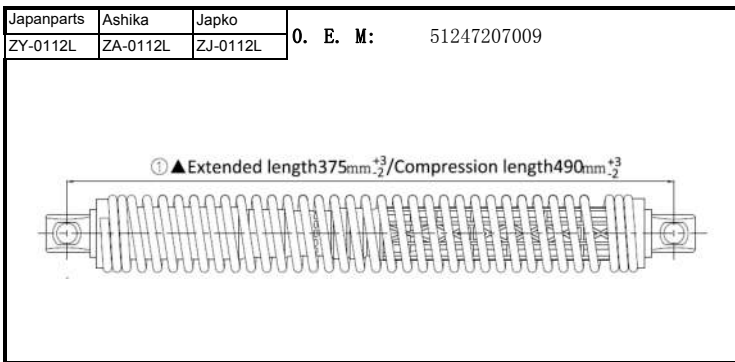

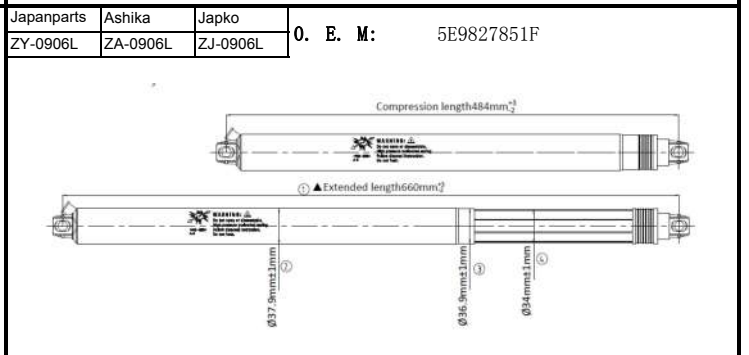
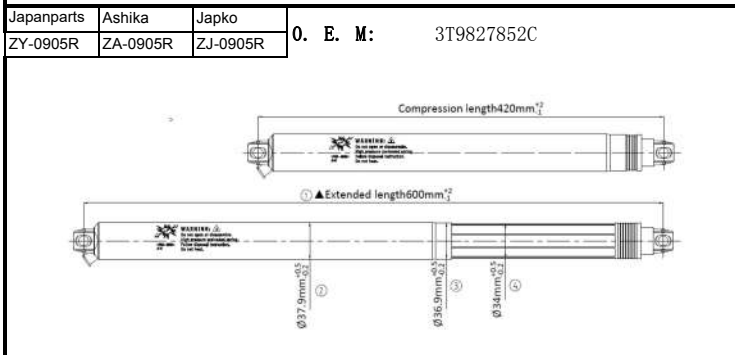
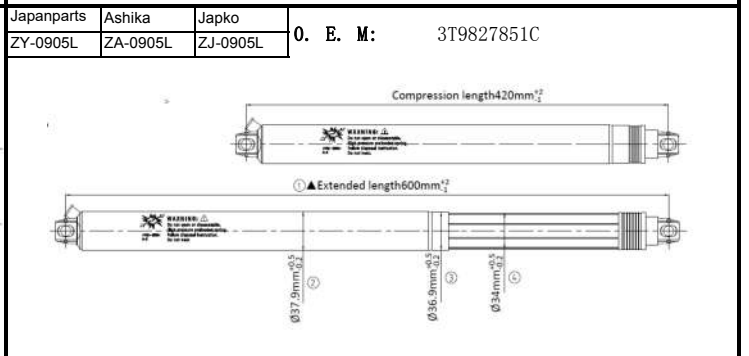
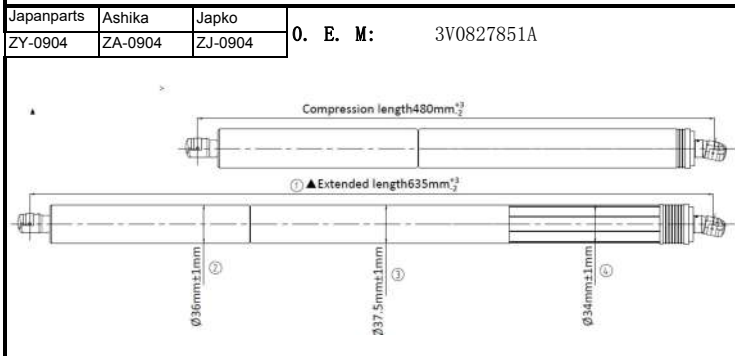
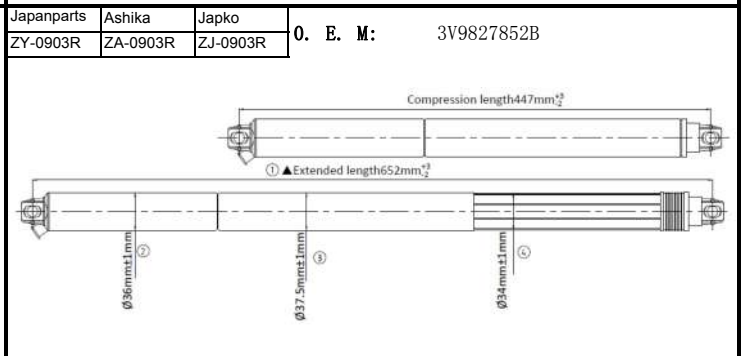
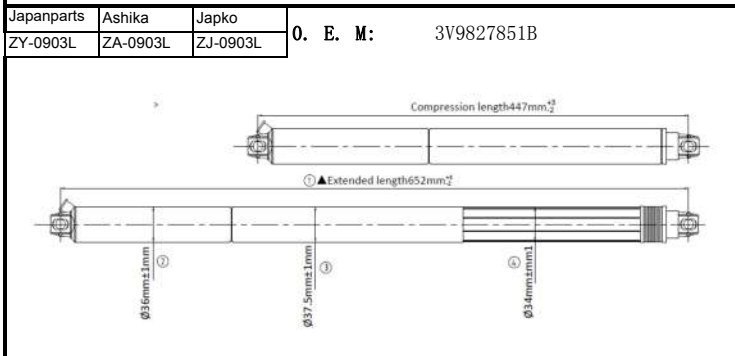
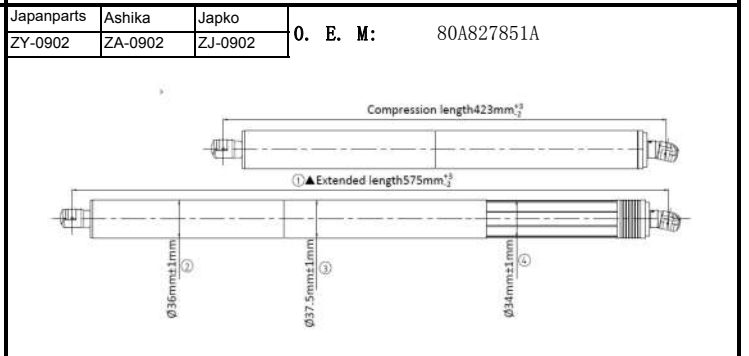
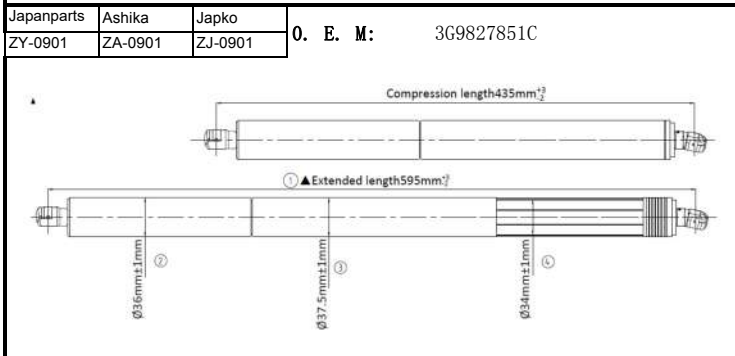
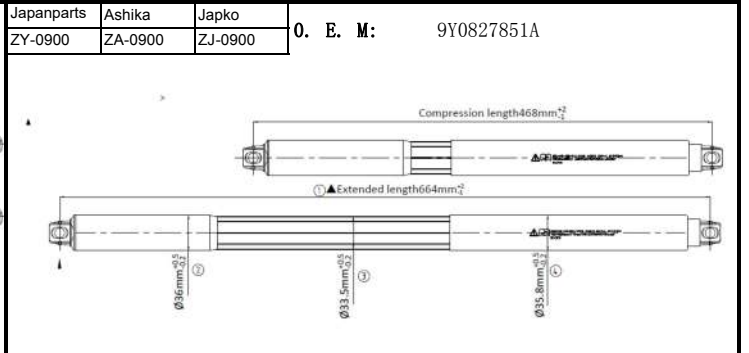
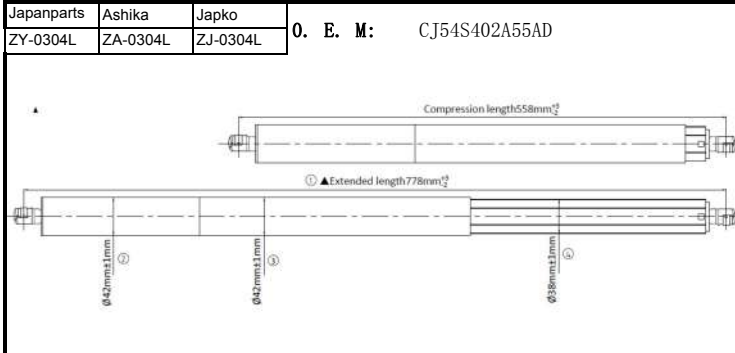
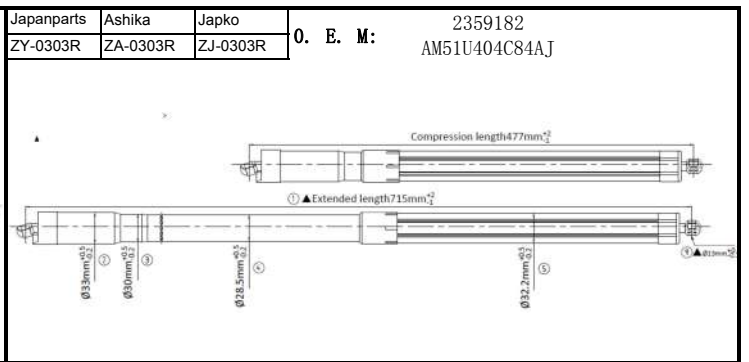
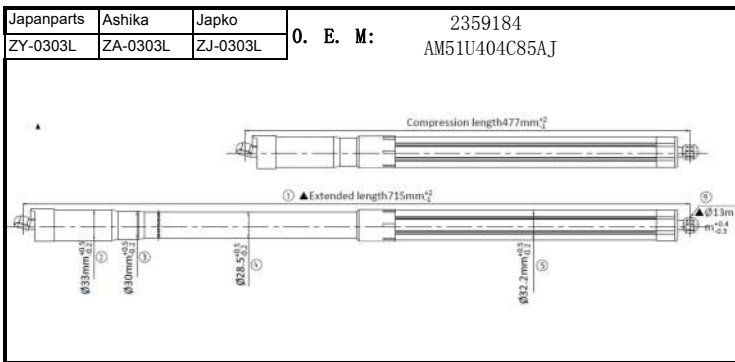

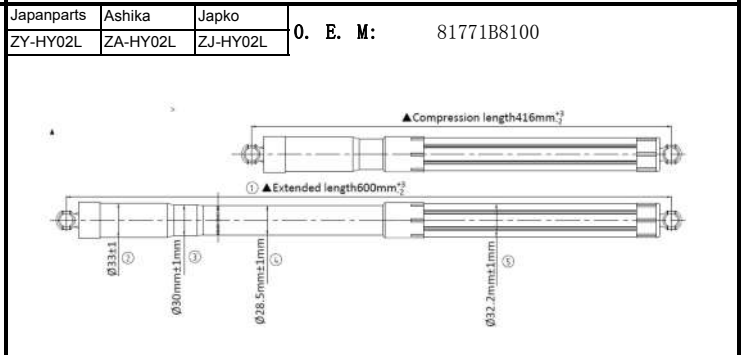
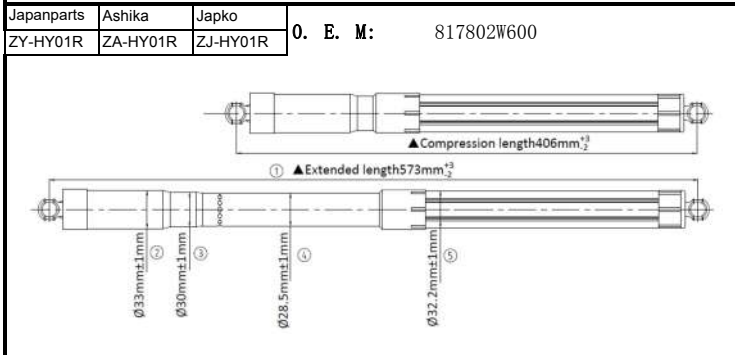
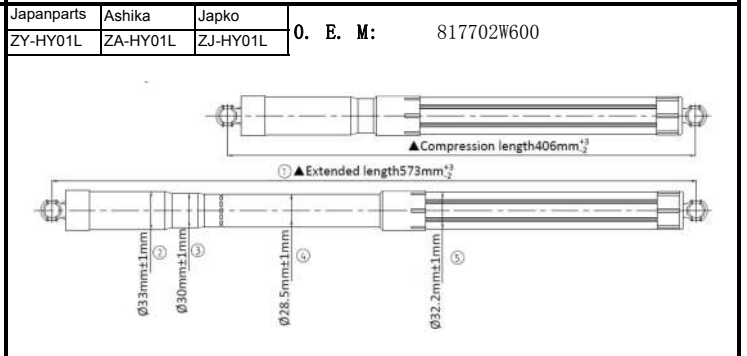
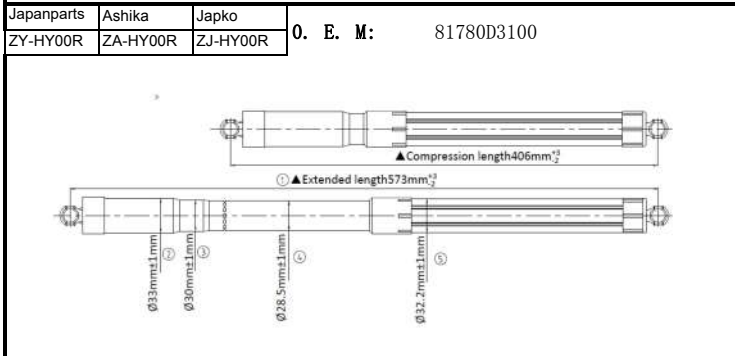
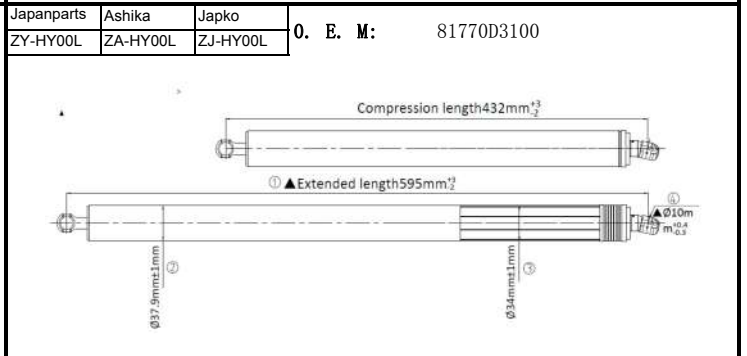
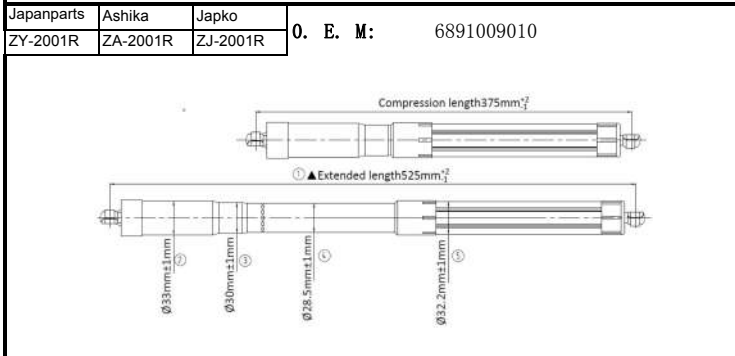
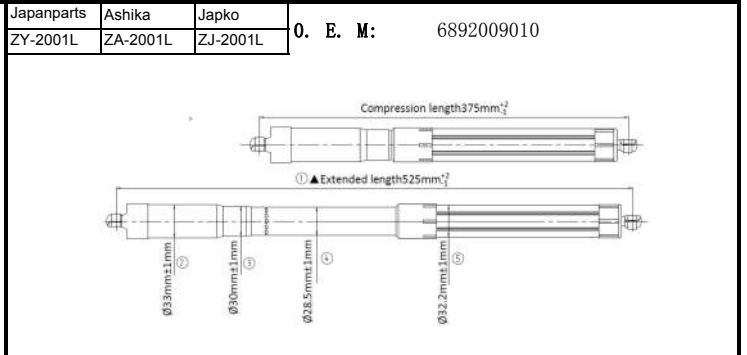
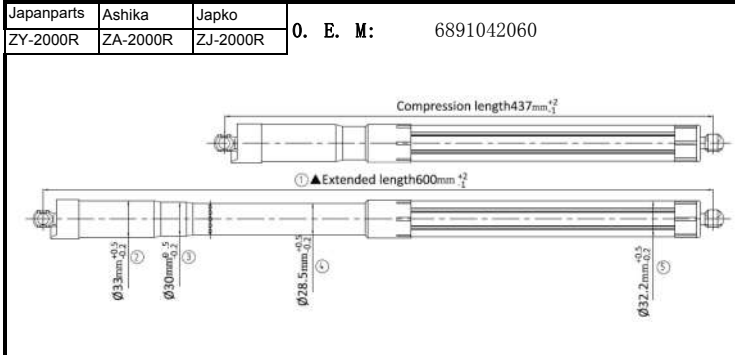
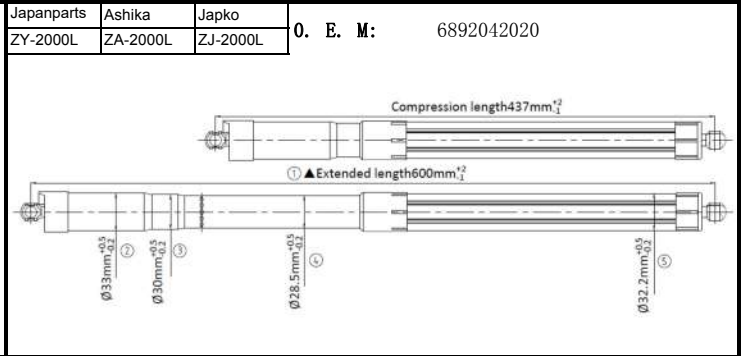
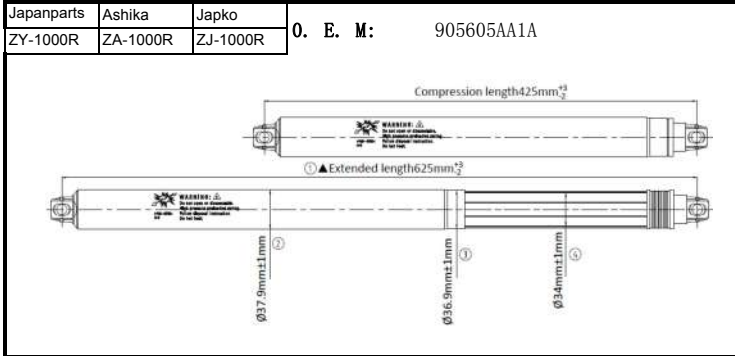
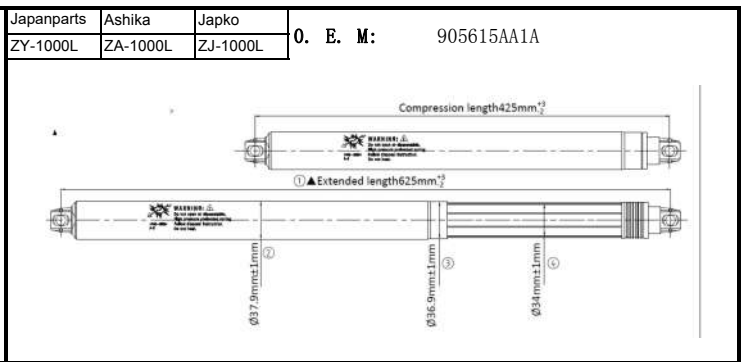
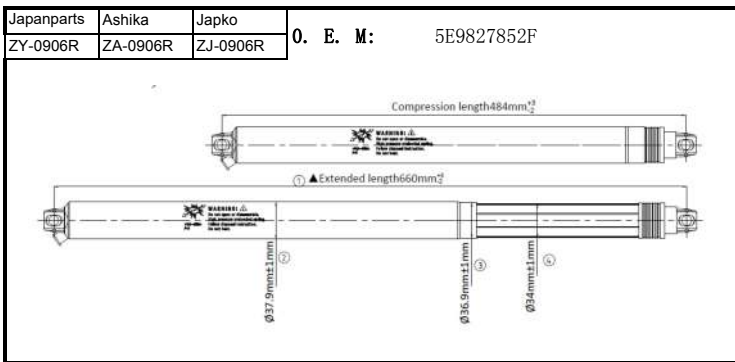

| | | |
|------------|----------|----------|
| Japanparts | Ashika | Japko |
| ZY-HY02R | ZA-HY02R | ZJ-HY02R |

O. E. M: 81780B8100

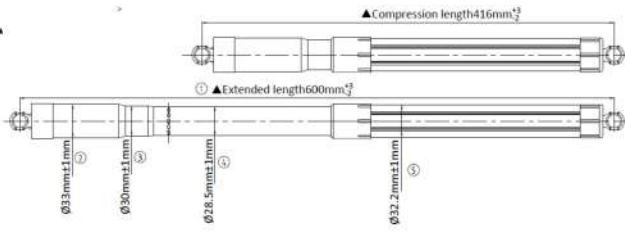

| | | |
|------------|---------|---------|
| Japanparts | Ashika | Japko |
| ZY-JG00 | ZA-JG00 | ZJ-JG00 |

O. E. M: HK8370354AA

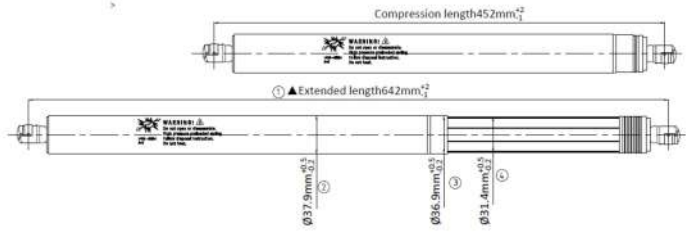

| | | |
|------------|---------|---------|
| Japanparts | Ashika | Japko |
| ZY-KI00 | ZA-KI00 | ZJ-KI00 |

O. E. M: 81770C5100

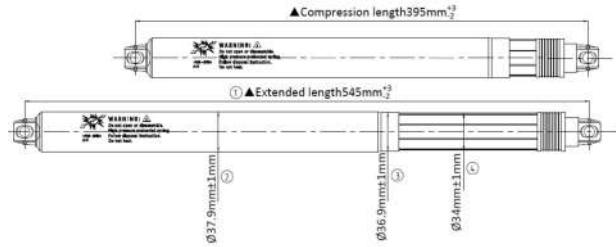

| | | |
|------------|---------|---------|
| Japanparts | Ashika | Japko |
| ZY-LR00 | ZA-LR00 | ZJ-LR00 |

O. E. M: LR058306

